

Nationale Hinterlegungen

In der folgenden Liste werden die beim Eidgenössischen Institut für Geistiges Eigentum hinterlegten Designs publiziert. Dabei sind der Reihe nach angegeben:

- internationale Klassenangaben
- Hinterlegungsnummer
- Hinterlegungsdatum
- Allenfalls Aufschub der Veröffentlichung
- Anzahl der hinterlegten Designs
- Bezeichnung
- Name und Wohnsitz des Hinterlegers oder der Hinterlegerin
- gegebenenfalls Name und Wohnsitz des Designers oder der Designerin
- Name und Geschäftssitz des allfälligen Vertreters oder der Vertreterin
- gegebenenfalls Prioritätsangaben
- gegebenenfalls Beschreibungstext
- Ordnungsnummer
- Reproduktion des Designs

Internationale Hinterlegungen

Die bei der Weltorganisation für geistiges Eigentum in Genf hinterlegten Muster und Modelle mit Benennung Schweiz geniessen den gleichen Schutz wie national hinterlegte Designs. Sie werden jeweils im Blatt «Bulletin des dessins et modèles internationaux» veröffentlicht. Dieses Publikationsorgan ist deshalb für eine vollständige Recherche unbedingt beizuziehen.

Topographien

Angaben über die vom Eidgenössischen Institut für Geistiges Eigentum eingetragenen Topographien von Halbleitererzeugnissen werden in folgender Anordnung aufgeführt:

- Eintragsnummer
- Anmeldedatum
- Bezeichnung
- Name und Wohnsitz des Anmelders oder der Anmelderin
- gegebenenfalls Name und Wohnsitz des Herstellers oder der Herstellerin
- Name und Geschäftssitz des oder der allfälligen Bevollmächtigten
- Datum und Ort einer allfälligen ersten geschäftlichen Verbreitung der Topographie

Dépôts nationaux

Les designs déposés à l'Institut Fédéral de la Propriété Intellectuelle sont publiés dans la liste qui suit. Les indications y relatives sont mentionnées dans cet ordre:

- indications des classes internationales
- numéro de dépôt
- date de dépôt
- le cas échéant, ajournement de la publication
- nombre des designs déposés
- désignation
- nom et domicile du/de la déposant/e
- le cas échéant, nom et domicile du/de la designer
- nom et domicile de l'éventuel/le mandataire
- le cas échéant, indication de priorité
- le cas échéant, description du design
- numéro attribué à chaque design
- reproduction du design

Dépôts internationaux

Les dessins et modèles déposés à l'Organisation Mondiale de la Propriété Intellectuelle à Genève qui désignent la Suisse jouissent de la même protection que les dépôts nationaux. Ils sont chaque fois publiés dans la feuille «Bulletin des dessins et modèles internationaux». Pour une recherche complète, il est indispensable de consulter ledit organe de publication.

Topographies

Les indications concernant les topographies des produits semi-conducteurs, enregistrées par l'Institut Fédéral de la Propriété Intellectuelle, sont énumérées dans l'ordre suivant:

- numéro d'enregistrement
- date de dépôt
- désignation
- nom et domicile du/de la déposant/e
- le cas échéant, nom et domicile du/de la producteur/trice
- nom et domicile de l'éventuel/le mandataire
- date et lieu d'une éventuelle première mise en circulation de la topographie

Depositi nazionali

Nella lista seguente vengono pubblicati i design depositati presso l'Istituto Federale della Proprietà Intellettuale. Sono menzionati nel seguente ordine:

- indicazioni delle classi internazionali
- numero di deposito
- data del deposito
- se del caso, indicazione che la pubblicazione è stata differita
- numero dei design depositati
- designazione
- nome e domicilio del depositante
- se del caso, nome e domicilio del designer
- nome e sede di un eventuale mandataro
- se del caso, indicazioni di priorità
- se del caso, descrizione del design
- numero d'ordine
- riproduzione del design

Depositi internazionali

I disegni e modelli depositati presso l'Organizzazione Mondiale della Proprietà Intellettuale a Ginevra con denominazione Svizzera godono della medesima protezione del deposito nazionale. Essi vengono pubblicati ogni volta nel foglio «Bulletin des dessins et modèles internationaux». Quest'organo di pubblicazione è da consultare se si vuole effettuare una ricerca completa.

Topografie

Le indicazioni concernenti le topografie di prodotti a semiconduttori depositati presso l'Istituto Federale della Proprietà Intellettuale sono menzionate nell'ordine seguente:

- numero di registrazione
- data del deposito
- designazione
- nome e domicilio del/la richiedente
- se del caso, nome e domicilio del/la produttore/trice
- nome e sede di un eventuale mandataro
- data e luogo di un'eventuale prima messa in circolazione della topografia

Hinterlegungen Dépôts Deposit

Cl. 23-01 133 548 19.01.2007
1 Design – Armatur
Hinterleger: KWC AG, Hauptstrasse 57, 5726 Unterkulm
Designer: Michael Lammell, Aachen; Michael Zeisel, Aachen
Vertreter: Patentanwälte, Schaad, Balass, Menzl & Partner AG, 8034 Zürich
Ende aufgeschobene Publikation:
1 (siehe Farbteil Heftmitte)

Cl. 09-07 133 813 26.04.2007
1 design – bouchon
Déposant: Société des Produits Nestlé SA, 1800 Vevey
Designer: Philippe Gaus, Plan-les-Ouates
Mandataire: Nestec S.A., 1800 Vevey
Fin de la période ajournement de la publication:

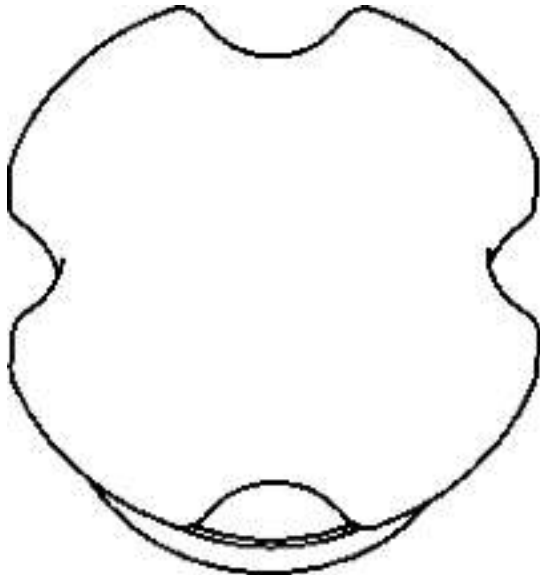

FL 65307

Cl. 09-07 133 814 26.04.2007
1 design – bouchon
Déposant: Société des Produits Nestlé SA, 1800 Vevey
Designer: Philippe Gaus, Plan-les-Ouates
Mandataire: Nestec S.A., 1800 Vevey
Fin de la période ajournement de la publication:

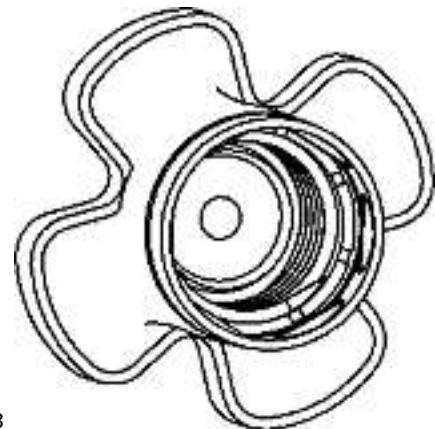
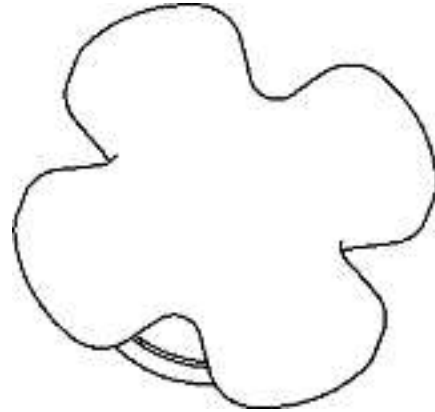

FL 65308

Cl. 02-03 134 618 12.12.2007
3 Design – Schildkappe
Hinterleger: Christophe Walch, St. Alban-Rheinweg 170, 4052 Basel
Vertreter: Braunpat Braun Eder AG, 4054 Basel

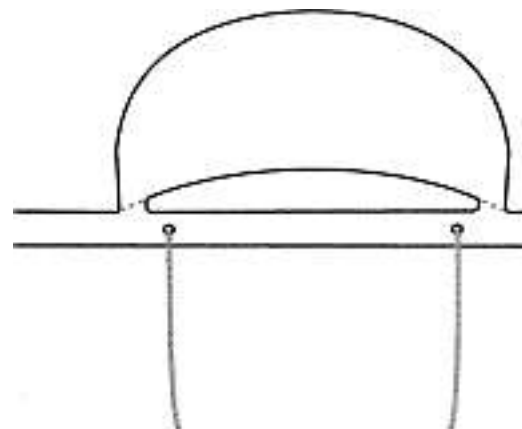

1

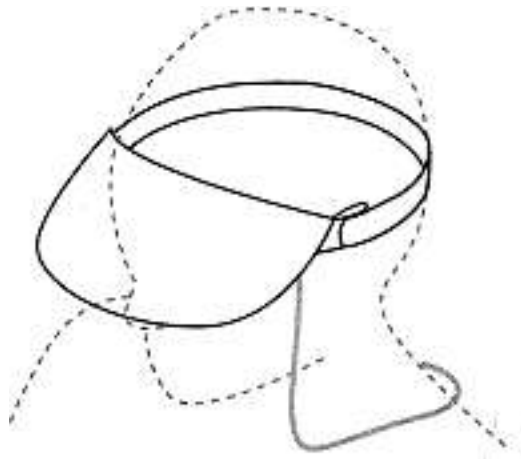

Cl. 02-03 134 619 21.12.2007
1 design – chapellerie
Déposant: Javier Christe, Chemin de Champ-Joly n° 7,
1228 Plan-les-Ouates
Designer: José Francisco Cherini, Córdoba

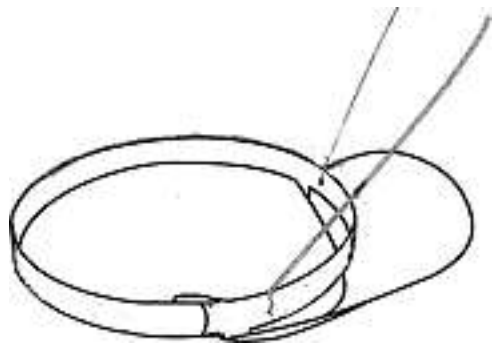

2



3



63963

Cl. 02-04 134 620 06.12.2007
 3 Design – Schuhbekleidung
 Hinterleger: Jason Thai, Hohlstrasse 615, 8048 Zürich
 Vertreter: Schneider Feldmann AG, Patent- und
 Markenanwälte, 8022 Zürich

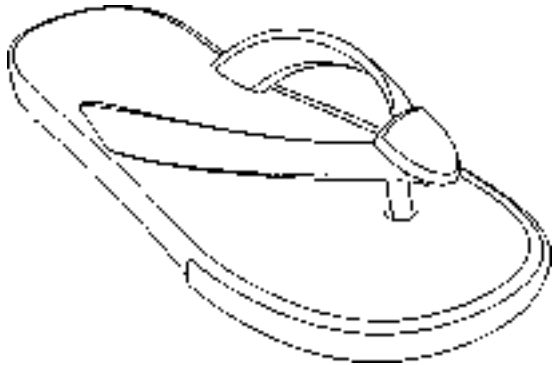

2

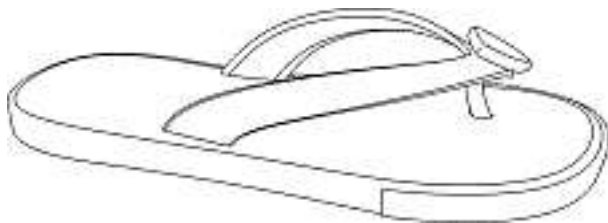

3



Cl. 02-04 134 621 19.12.2007
 2 Design – Einlegesohlen
 Hinterleger: Medreflexx GmbH, Schwedenstrasse 37,
 80805 München, DE
 Designer: Gregor Pfaff, München
 Vertreter: Meyer Marks AG, 5620 Bremgarten AG
 Priorität: EM, 27.06.2007



1

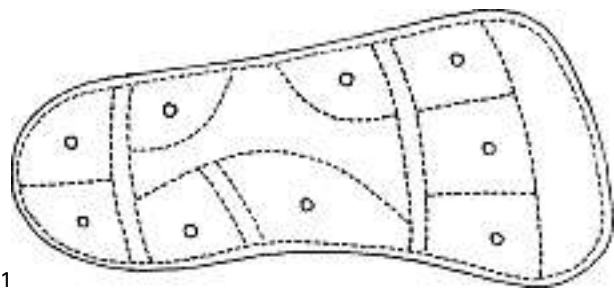

1

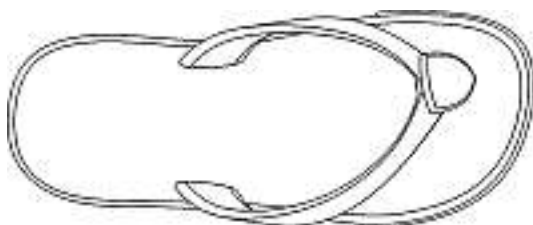

2

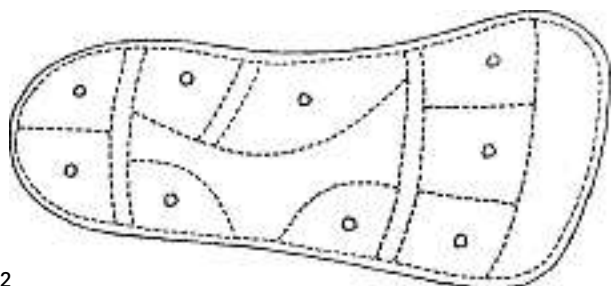

Cl. 04-02 **134 622** 21.12.2007
 1 Design – Zahnbürste-Borsten
 Hinterleger: GlaxoSmithKline Consumer Healthcare,
 GmbH & Co. KG, Bussmatten 1, Bühl, DE
 Designer: Christoph Geiberger, Königswinter
 Vertreter: Isler & Pedrazzini AG, 8027 Zürich
 Priorität: GB, 28.06.2007

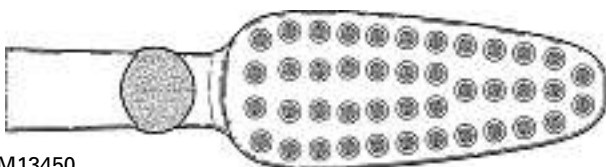
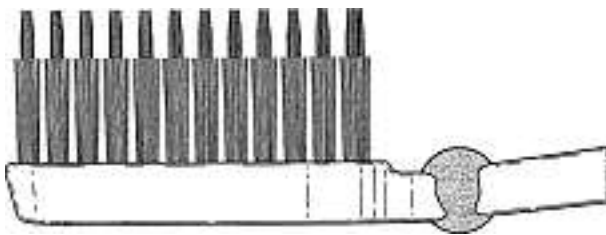

M13450

Cl. 05-06 **134 623** 17.12.2007
 1 design – motif de gaufrage pour papier absorbant
 Déposant: Georgia-Pacific France, 11, route Industrielle,
 68320 Kunheim, FR
 Designer: Donald Barredo, Ingersheim; Jean-Bernard Kuehn,
 Bennwihr
 Mandataire: MICHELI & CIE SA, 1226 Thônex
 Priorité: EM, 20.07.2007

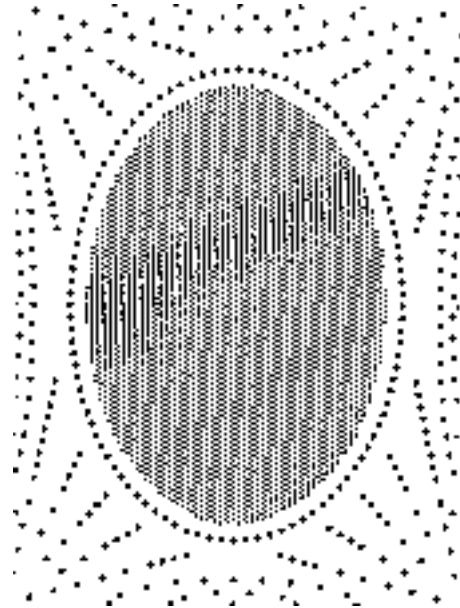

15177A

Cl. 06-01, 06-03, 06-04 **134 624** 03.12.2007
 33 design – chaises, tabourets, chaises longues, bancs,
 fauteuils, tables, coffre de rangement
 Déposant: MWH-Metallwerk Helmstadt GmbH,
 Flinsbacher Strasse 1, Helmstadt, DE
 Designer: Werner Rech, Illingen; Marina Beisel,
 Neckarbischofsheim; Arno Lang, Heidelberg; Norbert
 Widmann, Hüffenhardt; Hans J. Theemann, Sinsheim
 Mandataire: reuteler & cie S.A., 1260 Nyon
 Priorité: EM, 11.06.2007

- 1 (siehe Farbteil Heftmitte)
- 2 (siehe Farbteil Heftmitte)
- 3 (siehe Farbteil Heftmitte)
- 4 (siehe Farbteil Heftmitte)
- 5 (siehe Farbteil Heftmitte)
- 6 (siehe Farbteil Heftmitte)
- 7 (siehe Farbteil Heftmitte)
- 8 (siehe Farbteil Heftmitte)
- 9 (siehe Farbteil Heftmitte)
- 10 (siehe Farbteil Heftmitte)
- 11 (siehe Farbteil Heftmitte)
- 12 (siehe Farbteil Heftmitte)
- 13 (siehe Farbteil Heftmitte)
- 14 (siehe Farbteil Heftmitte)
- 15 (siehe Farbteil Heftmitte)
- 16 (siehe Farbteil Heftmitte)
- 17 (siehe Farbteil Heftmitte)
- 18 (siehe Farbteil Heftmitte)
- 19 (siehe Farbteil Heftmitte)
- 20 (siehe Farbteil Heftmitte)
- 21 (siehe Farbteil Heftmitte)
- 22 (siehe Farbteil Heftmitte)
- 23 (siehe Farbteil Heftmitte)
- 24 (siehe Farbteil Heftmitte)
- 25 (siehe Farbteil Heftmitte)
- 26 (siehe Farbteil Heftmitte)
- 27 (siehe Farbteil Heftmitte)
- 28 (siehe Farbteil Heftmitte)
- 29 (siehe Farbteil Heftmitte)
- 30 (siehe Farbteil Heftmitte)
- 31 (siehe Farbteil Heftmitte)
- 32 (siehe Farbteil Heftmitte)
- 33 (siehe Farbteil Heftmitte)

Cl. 06-01 134 625 11.12.2007
 1 Design – Stuhl
 Hinterleger: G-Collection Verkaufs GmbH, Landstrasse 4,
 6418 Rothenthurm
 Designer: Pirmin Lüönd, Rothenthurm



60.100

Cl. 06-01, 06-03, 06-06 134 626 11.12.2007
 5 Design – Tisch, Hocker, Möbelprofile
 Hinterleger: Martina Grotensohn, Raumerstrasse 11,
 10437 Berlin, DE
 Vertreter: Lukas Frösch, 3011 Bern

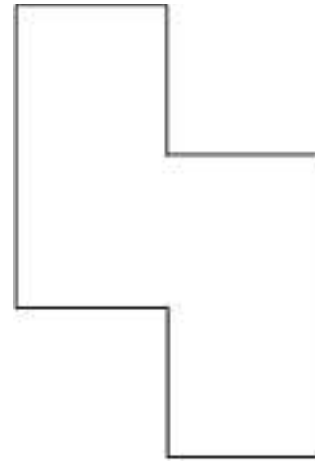
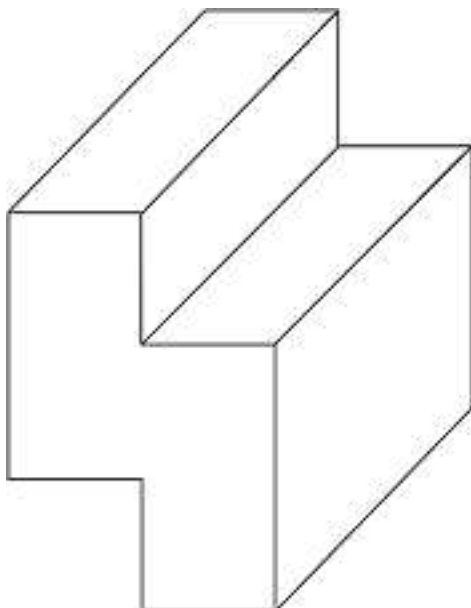

mp_01

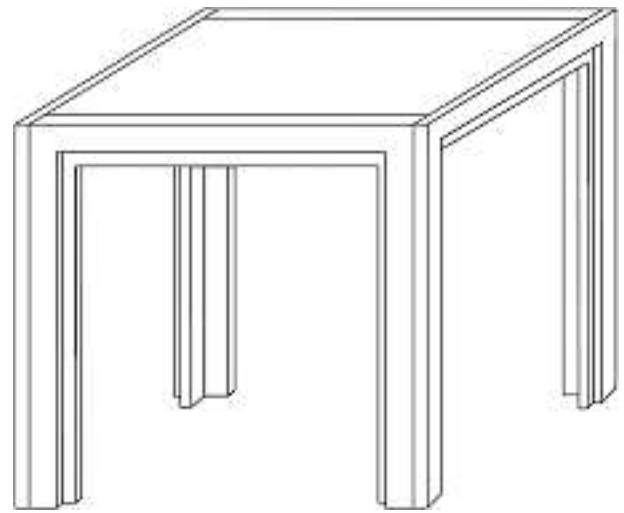

ho_01

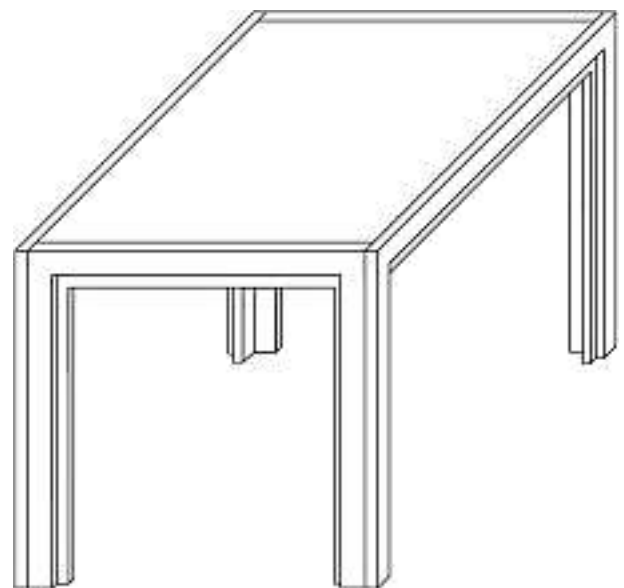

ti_01

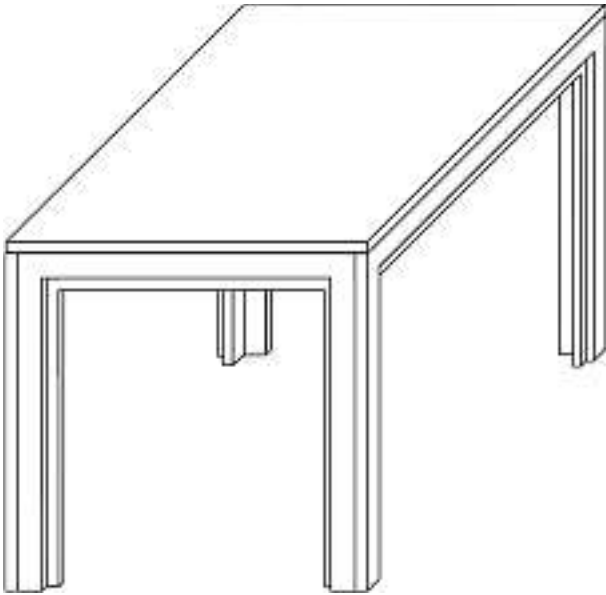

ti_02

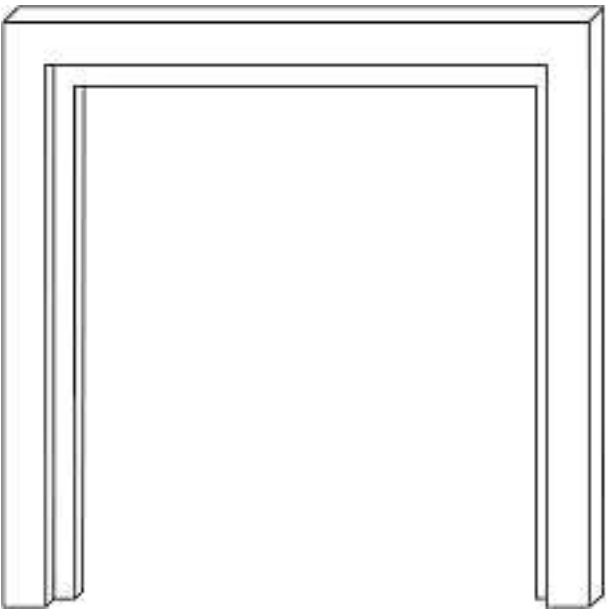

ur_01

Cl. 06-03, 06-06 134 627 12.10.2007
5 Design - Tische, Tischgestell
Hinterleger: Thomas Aregger, Neudörfli 12, 5603 Staufen

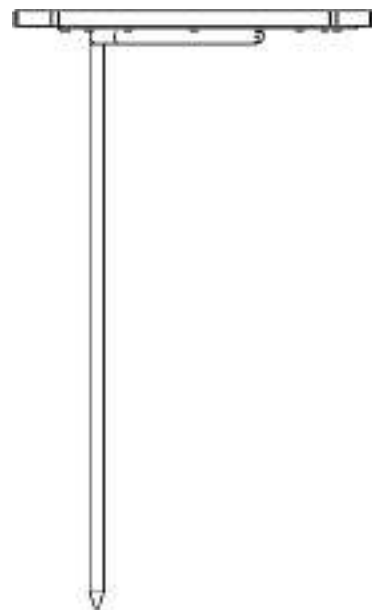

Tisch rund

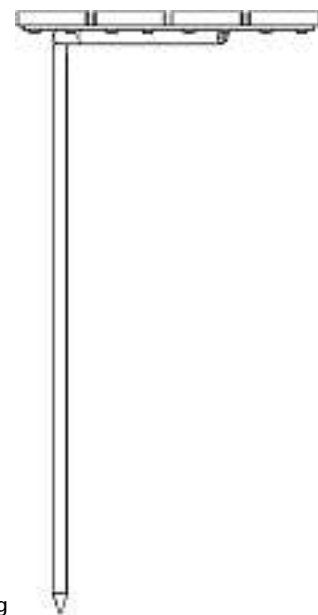
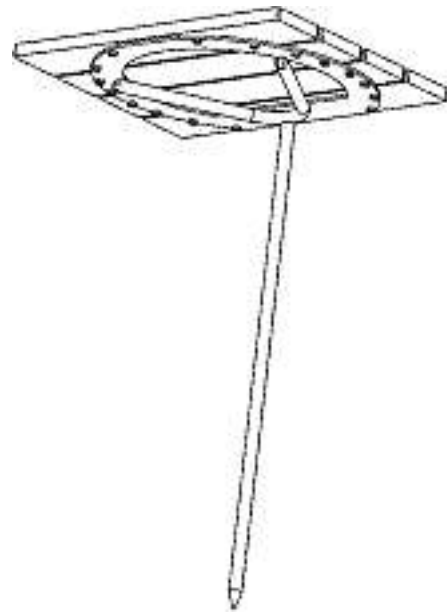
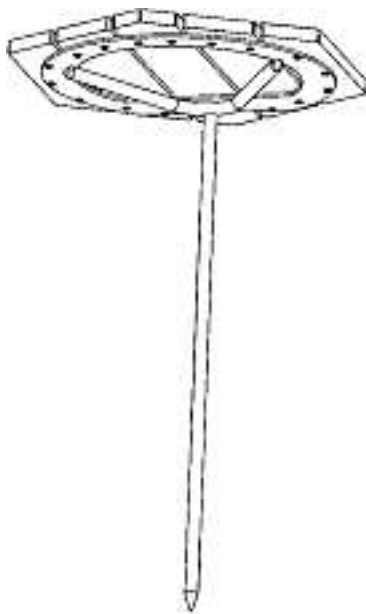

Tisch sechseckig

Tisch viereckig

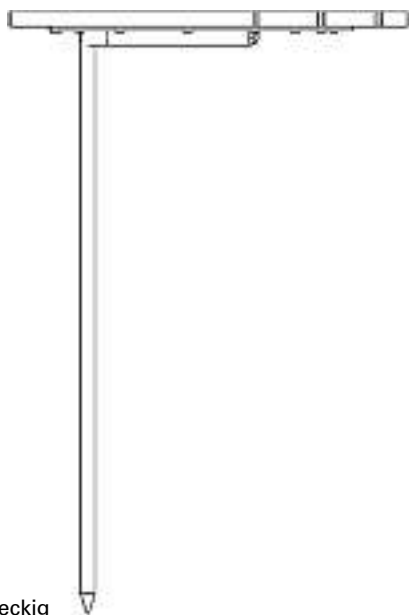
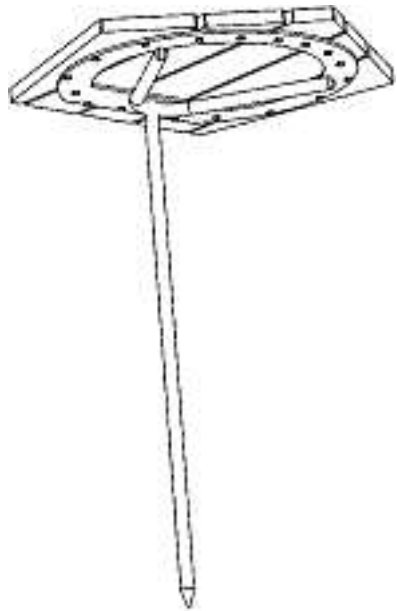

Tisch fünfeckig



Tischgestell

Cl. 06-10, 06-11, 06-12, 134 628 19.12.2007
 06-13
 3 design – tende, tappeti da pavimento e da muro, coperte
 Depositante: Chilewich Sultan LLC, 44 East 32nd Street,
 New York / NY 10016, US
 Designer: Sandra Chilewich, New York
 Mandatario: Kemia SA, 6915 Pambio-Noranco
 Priorità: JP, 24.10.2007; JP, 24.10.2007; JP, 27.10.2007

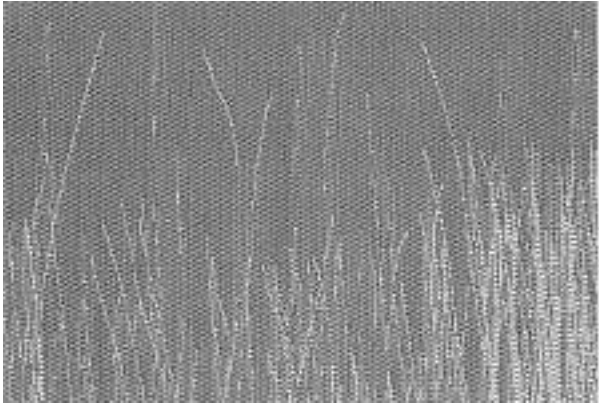

3109-01



3109-02



3109-03

Cl. 07-01, 07-06 134 629 14.12.2007
 2 Design – Schale, Nussknacker
 Hinterleger: Pi-Design AG, Kantonsstrasse 100,
 6234 Triengen
 Designer: Jørgen Bodum, Meggen
 Vertreter: Isler & Pedrazzini AG, 8027 Zürich
 Priorität: DK, 20.06.2007

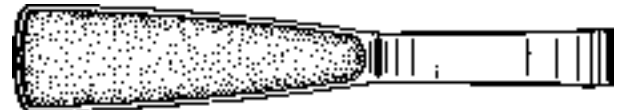
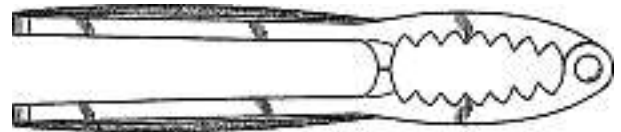
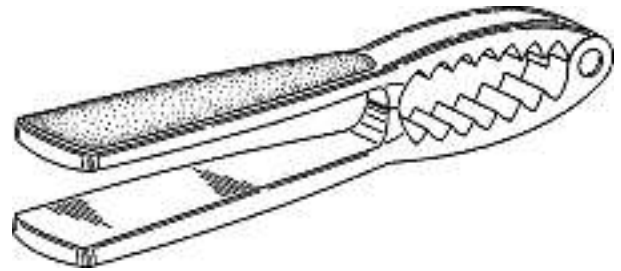

M13448-1

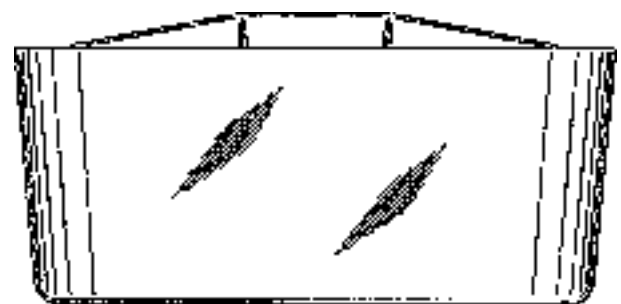
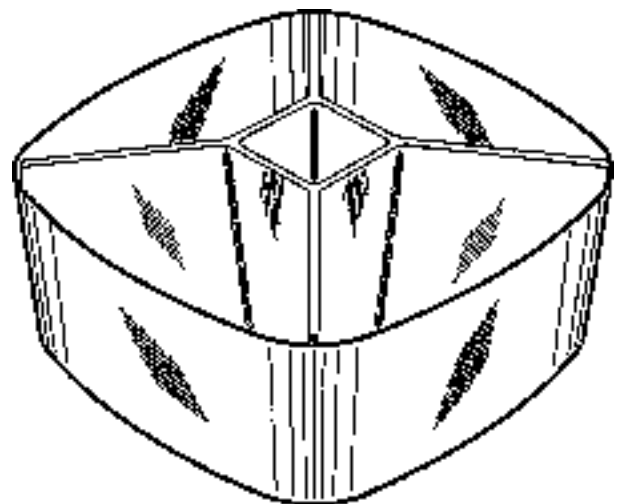

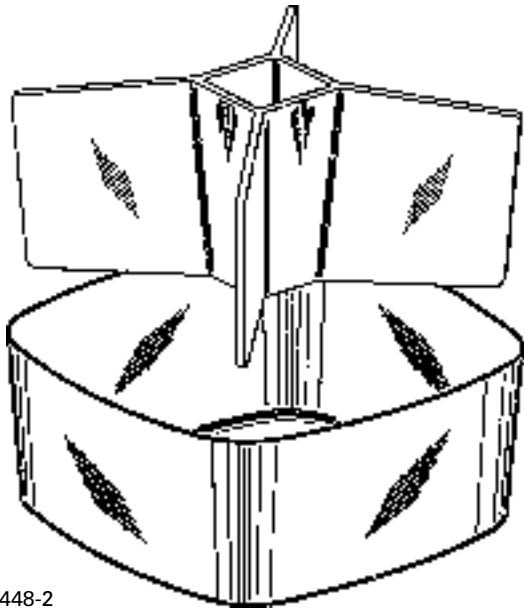

M13448-2

Cl. 07-01 134 630 19.12.2007
 2 Design – Getränkekanne
 Hinterleger: Pi-Design AG, Kantonsstrasse 100,
 6234 Triengen
 Designer: Jørgen Bodum, Meggen
 Vertreter: Isler & Pedrazzini AG, 8027 Zürich
 Priorität: DK, 04.07.2007





M13428-1



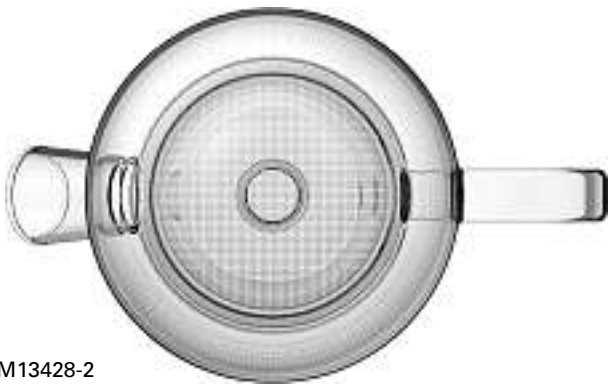

M13428-2

Cl. 07-02 **134 631** 17.12.2007
 2 Design – Kaffeebereiter
 Hinterleger: Pi-Design AG, Kantonsstrasse 100,
 6234 Triengen
 Designer: Jørgen Bodum, Meggen
 Vertreter: Isler & Pedrazzini AG, 8027 Zürich
 Priorität: DK, 18.06.2007

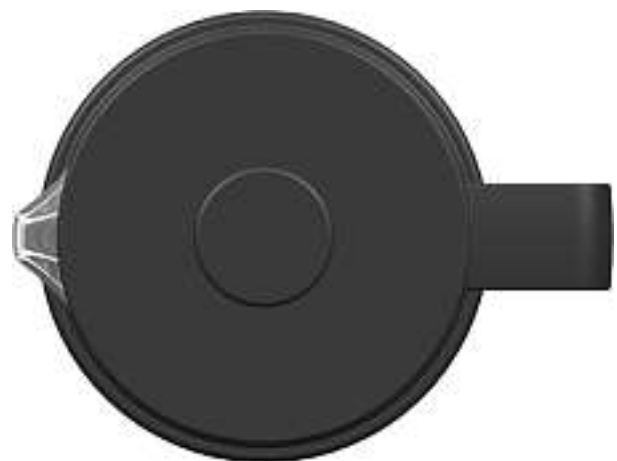



M13447-1

Cl. 07-02 **134 632** 19.12.2007
2 Design – Filter und Becher mit Filter
Hinterleger: Pi-Design AG, Kantonsstrasse 100,
6234 Triengen
Designer: Jørgen Bodum, Meggen
Vertreter: Isler & Pedrazzini AG, 8027 Zürich
Priorität: DK, 27.06.2007



M13447-2



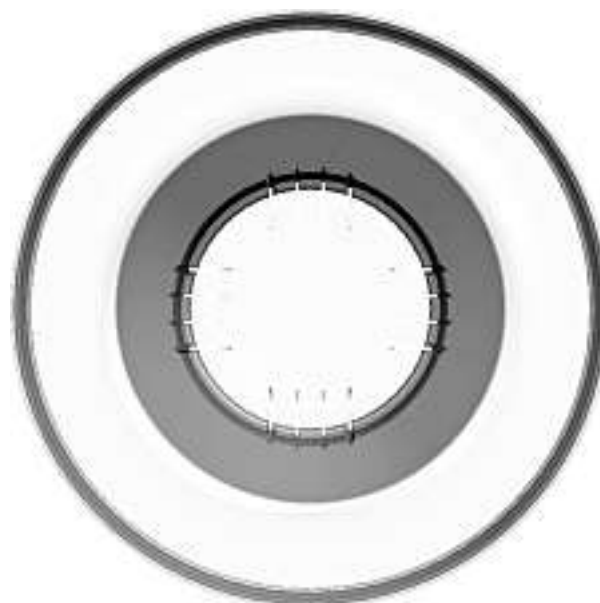
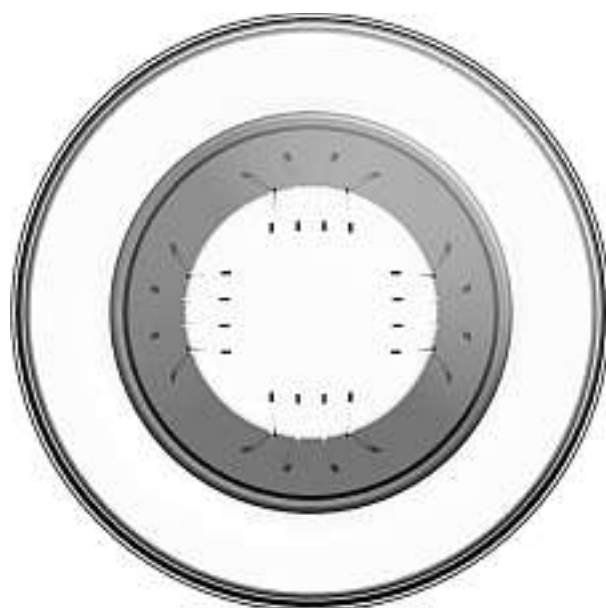

M13451-1



M13451-2

Cl. 07-02 134 634 21.12.2007

1 Design – Kaffeemaschine

Hinterleger: Breville Pty Limited, Building 2, Port Air Industrial Estate, 1A Hale Street, Botany NSW, AU

Designer: Robert Grassia, Botany

Vertreter: Keller & Partner, Patentanwälte AG, 3000 Bern 7

Priorität: AU, 20.07.2007

Beschreibung des Designs: Neuheit wird beansprucht für die Eigenschaften bezüglich Form und Aufbau der Kaffeemaschine wie in den beiliegenden Abbildungen dargestellt. Die in den Zeichnungen gestrichelt dargestellten Linien dienen nur zu Veranschaulichungszwecken und sind nicht Bestandteil des beanspruchten Modells.

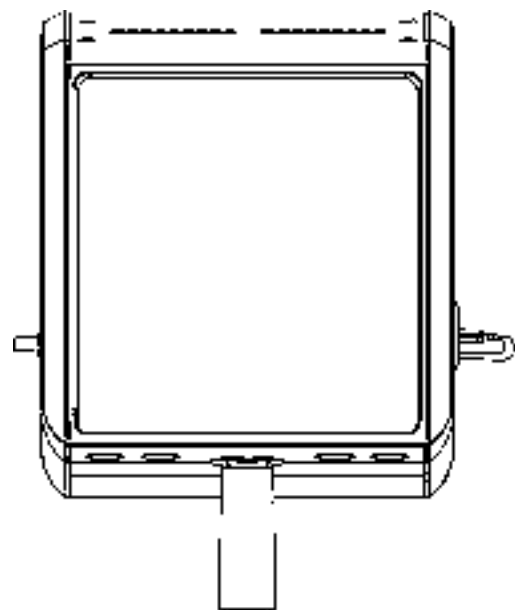
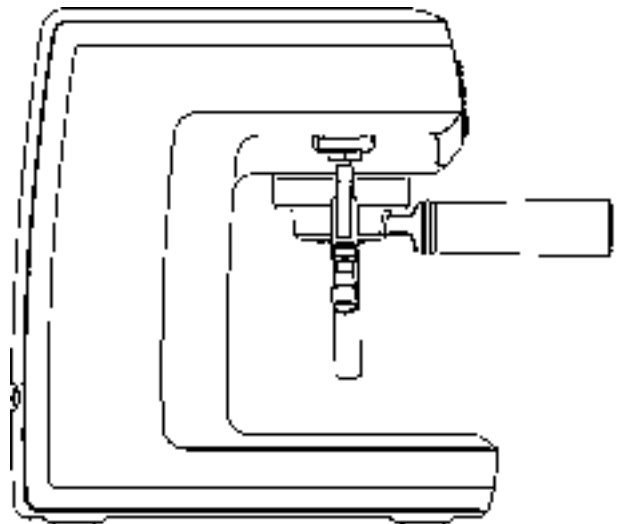
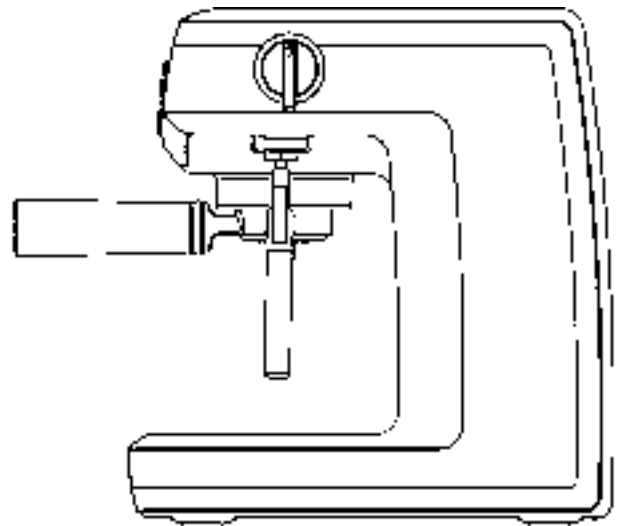
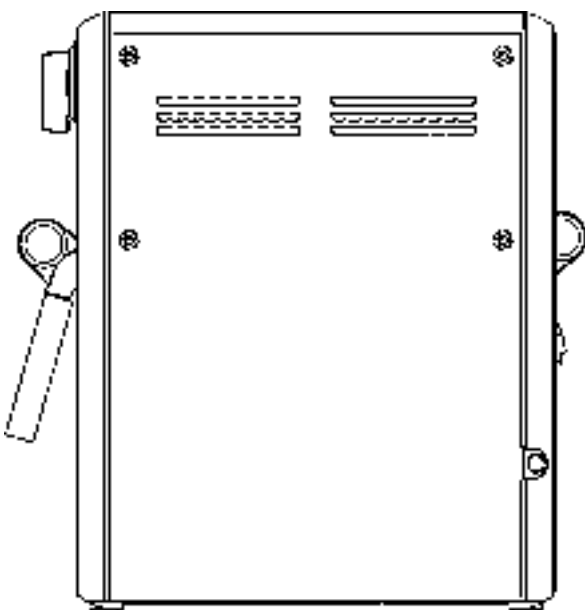
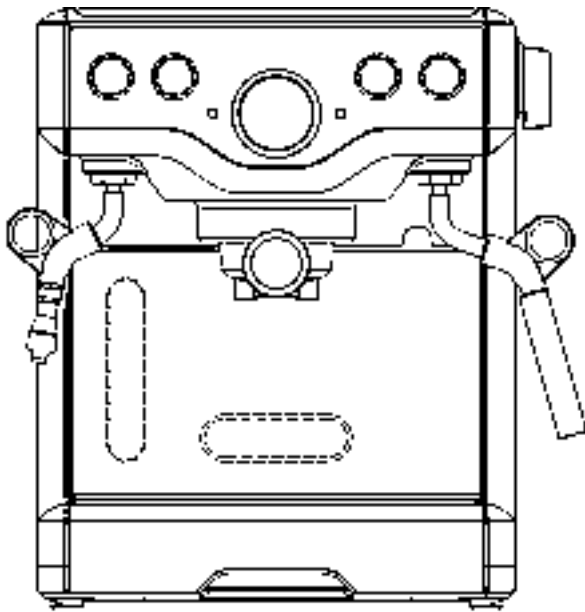

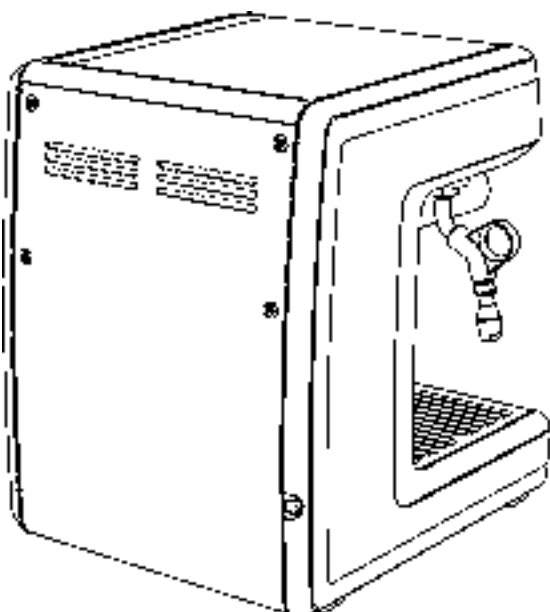
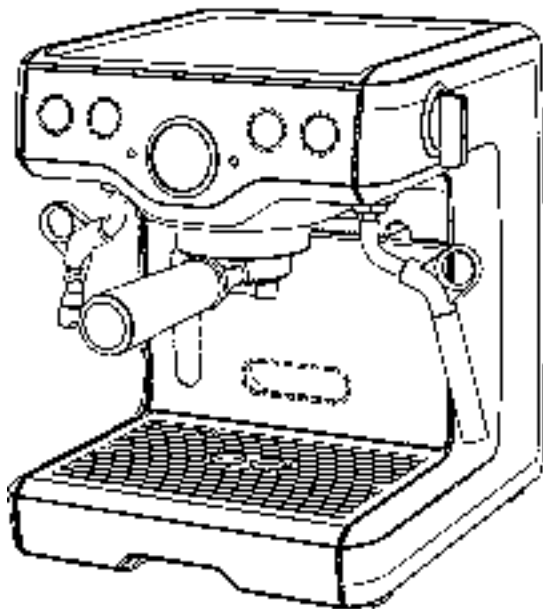
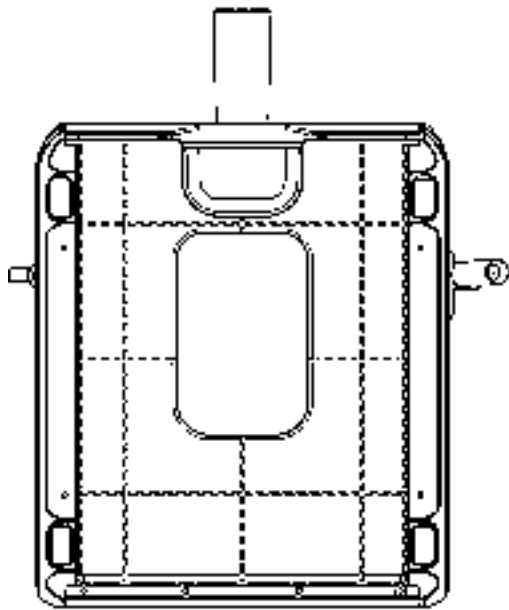

1

Cl. 07-03, 07-04, 07-06 134 635 14.12.2007
3 Design – Griff für Küchengerät, Küchengerät
Hinterleger: ICI USA, LLC, 2815 Eastlake Ave E, Suite 150,
Seattle, WA 98102, US
Designer: Matthew J. Frank, Seattle
Vertreter: Schmauder & Partner AG, Patent- und
Markenanwälte VSP, 8038 Zürich

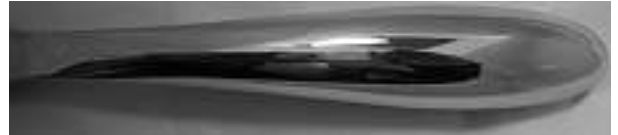

1



2



3



Cl. 07-05 134 636 11.12.2007
 1 design – pincette à linge
 Déposant: Antonio Corchia, Lindenweg 11, 2503 Bienne

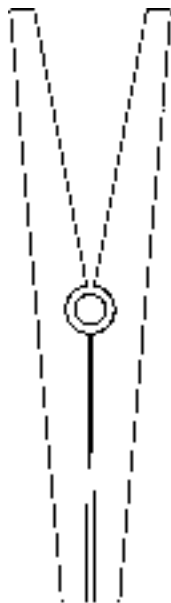

Pedix

Cl. 07-99 134 637 03.12.2007
 4 Design – Lederpflegemittel
 Hinterleger: Nanogate AG, Gewerbepark Eschberger Weg 18, 66121 Saarbrücken, DE
 Designer: Holger Zytur, Dittelbrunn; Salah Bendjabalah, Saarbrücken; Yvonne Klawitter, St. Ingbert; Katja Weigang, Saarbrücken; Gisela Ehl, Saarlouis
 Vertreter: Ritscher & Partner AG, 8702 Zollikon
 Priorität: EM, 26.06.2007; EM, 26.06.2007; EM, 26.06.2007; EM, 26.06.2007
 1 (siehe Farbteil Heftmitte)
 2 (siehe Farbteil Heftmitte)
 3 (siehe Farbteil Heftmitte)
 4 (siehe Farbteil Heftmitte)

Cl. 07-99 134 639 14.12.2007
 1 Design – Kapselbehälter
 Hinterleger: Wolfgang Schugk, Dollärgerten 12, 8934 Knonau



107

Cl. 08-03 134 640 03.01.2008
 3 design – impugnatura per decespugliatore, impugnatura di comando per decespugliatore
 Depositante: Honda Motor Co., Ltd., No. 1-1, 2-chome, Minami-aoyama, Minato-ku, Tokyo, JP
 Designer: Hiromi Yuzuriha, Saitama
 Mandatario: Fiammenghi-Fiammenghi, 6900 Lugano
 Priorità: JP, 19.07.2007; JP, 19.07.2007; JP, 19.07.2007





1







3

Cl. 08-08 **134 641** 29.11.2007
 8 Design – Klammer zu Duschenrinne
 Hinterleger: Schaco AG, Luzernerstrasse 19, 6030 Ebikon
 Designer: Hans Schacher, Ebikon
 Priorität: EM, 30.05.2007; EM, 30.05.2007; EM, 30.05.2007;
 EM, 30.05.2007; EM, 30.05.2007; EM, 30.05.2007;
 EM, 30.05.2007; EM, 30.05.2007
 1 (siehe Farbteil Heftmitte)
 2 (siehe Farbteil Heftmitte)
 3 (siehe Farbteil Heftmitte)
 4 (siehe Farbteil Heftmitte)
 5 (siehe Farbteil Heftmitte)
 6 (siehe Farbteil Heftmitte)
 7 (siehe Farbteil Heftmitte)
 8 (siehe Farbteil Heftmitte)

Cl. 10-02 **134 643** 20.12.2007
 4 design – montres-bracelets
 Déposant: Nina Ricci, 39, Avenue Montaigne, 75008 Paris, FR
 Designer: Charline Carton, Paris
 Mandataire: INFOSUISSE, Information Horlogère et
 Industrielle, 2302 La Chaux-de-Fonds





1





2





3



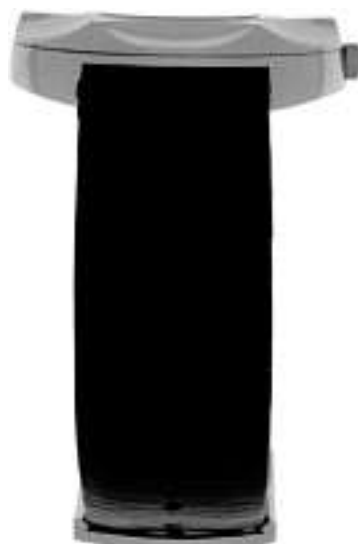

Cl. 10-07 134 644 14.12.2007
 9 design – montre, boîtier de montre, cadrans, aiguilles de
 montre, éléments décoratifs pour montre, bracelet et aiguil-
 les de montre, bracelet de montre
 Déposant: LES MONTRES FONTAINEMELON SA,
 c/o OGEFI Sàrl, rue de la Côte 3, 2052 Fontainemelon
 Designer: Bruno Capogreco, Genève
 Mandataire: Griffes Consulting S.A., 1206 Genève

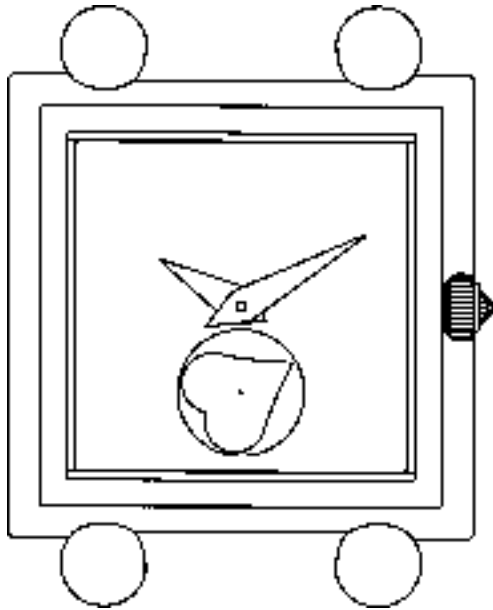

6091-MO-0004-CH-CH-01

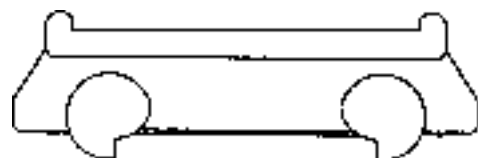
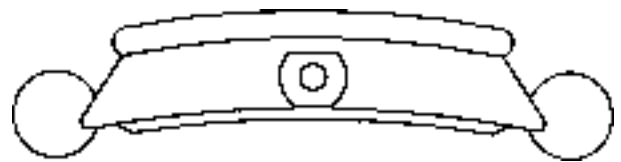
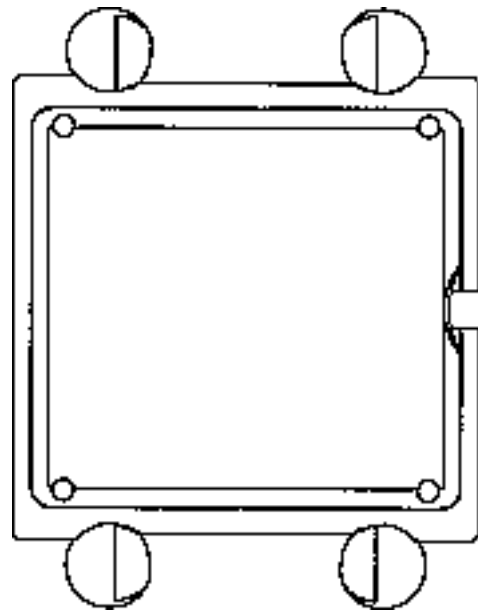
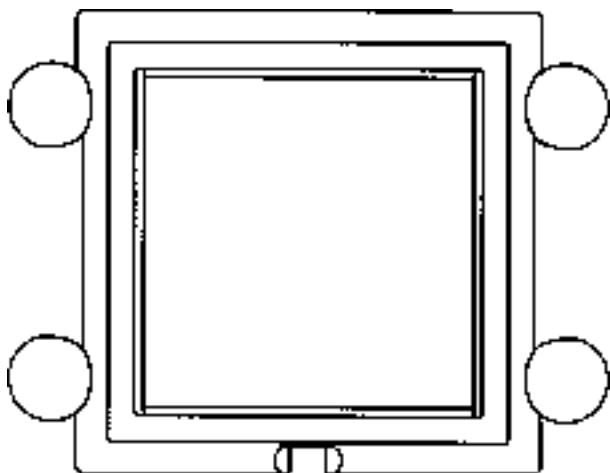
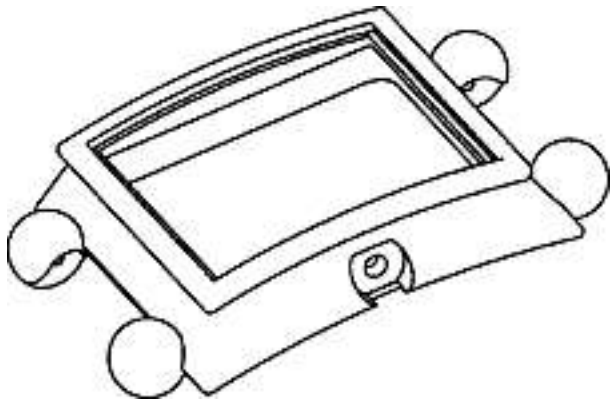

6091-MO-0005-CH-CH-01

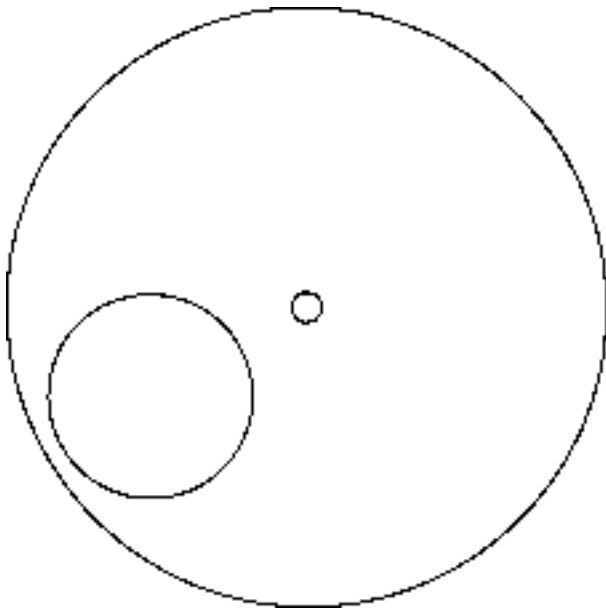

6091-MO-0006-CH-CH-01

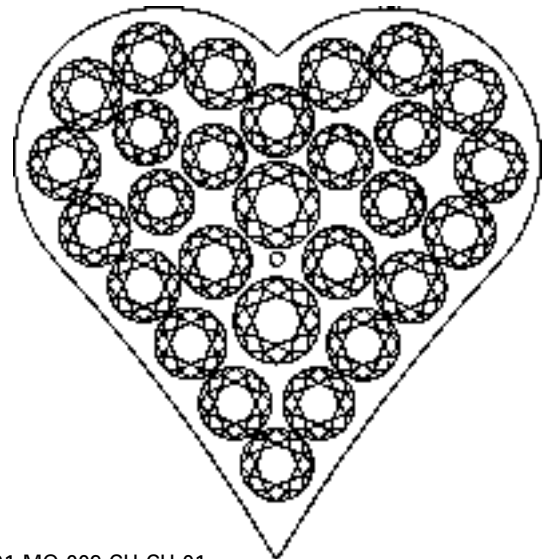

6091-MO-009-CH-CH-01

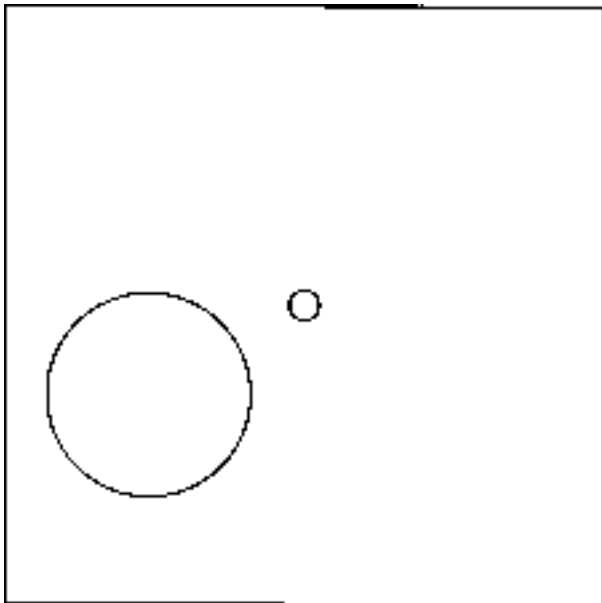

6091-MO-0007-CH-CH-01

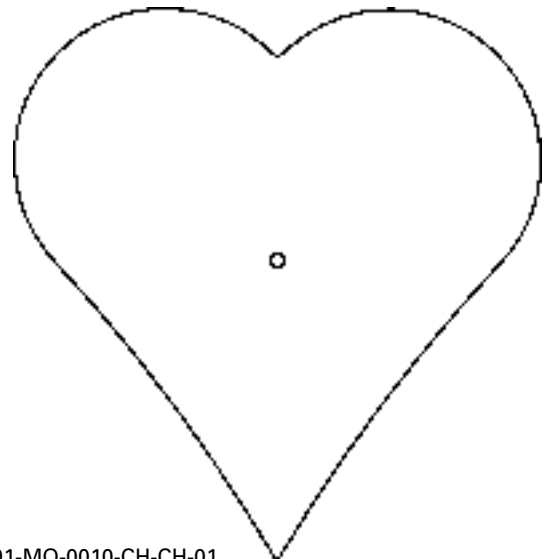

6091-MO-0010-CH-CH-01

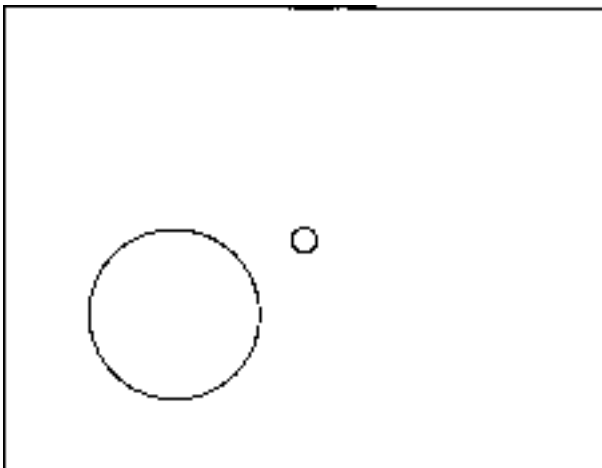

6091-MO-0008-CH-CH-01

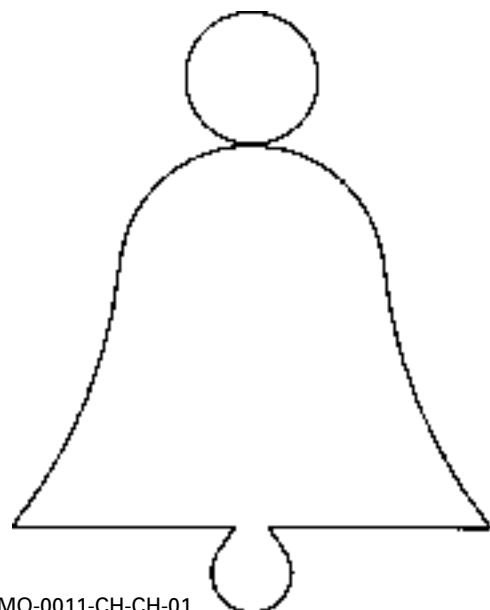

6091-MO-0011-CH-CH-01

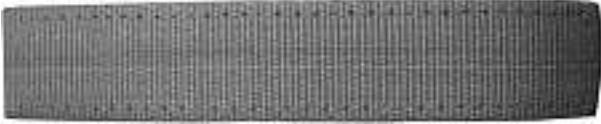

6091-MO-0012-CH-CH-01

Cl. 11-01 134 647 09.12.2007
4 design – bijoux
Déposant: Stéphanie Rizzi Pagano, rte du Village 26,
1509 Vucherens



6



4



7

Cl. 12-06 134 649 17.10.2007
1 Design – Floss
Hinterleger: Danielle Vetterli, Hallwylstrasse 72, 8004 Zürich;
Elisabeth Hillmann, Hagnestrasse 16, 14193 Berlin, DE
Vertreter: Danielle Vetterli, 8004 Zürich



5

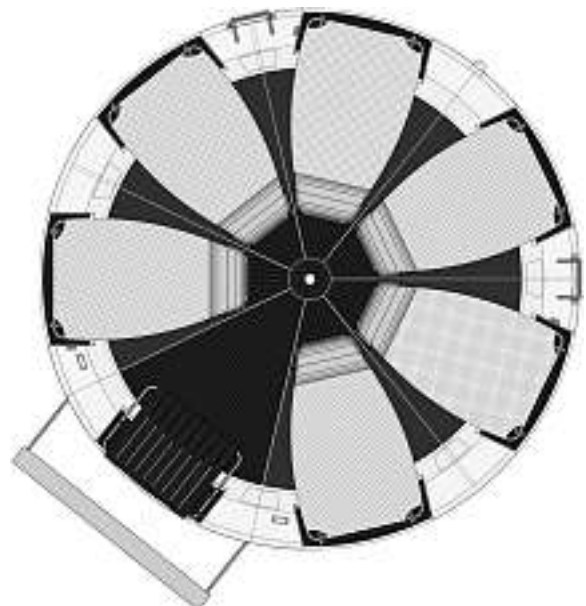

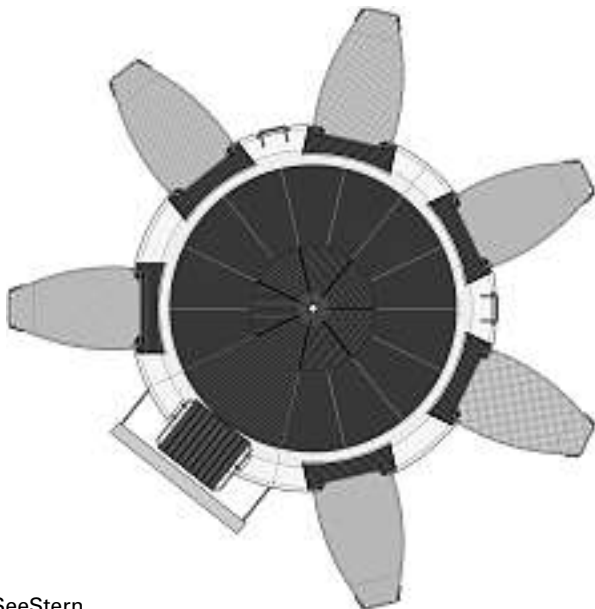
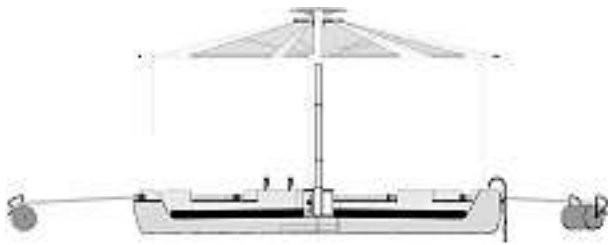
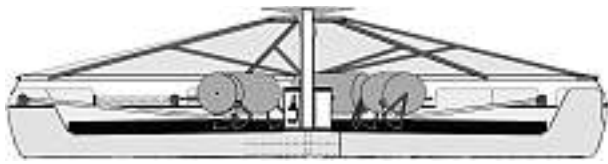

SeeStern

Cl. 13-03 **134 650** 20.12.2007
 16 Design – Montage- und Verdrahtungsvorrichtungen
 Hinterleger: Siemens Aktiengesellschaft, Wittelsbacherplatz 2,
 München, DE
 Designer: Thomas Detemple, Planegg; Martin Bodenmeier,
 Parkstein; Peter Trautwein, München; Manuela Lüftl, Amberg
 Vertreter: Siemens Schweiz AG, 8047 Zürich
 Priorität: EM, 06.08.2007

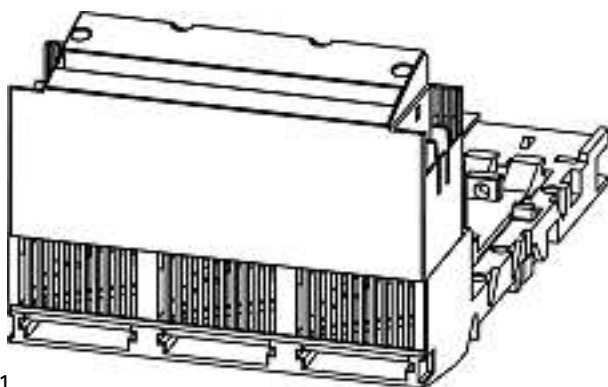

1

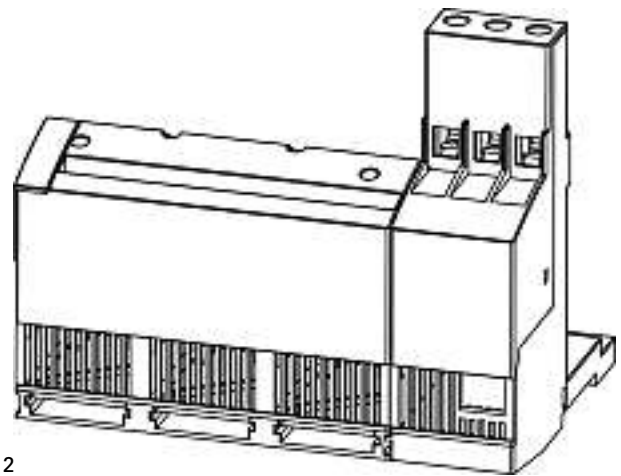

2

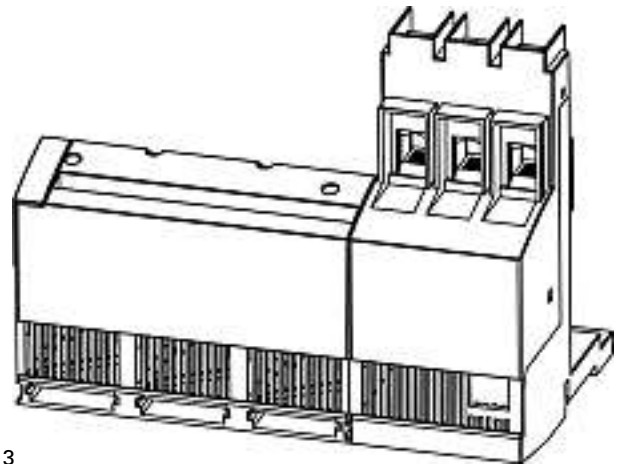

3

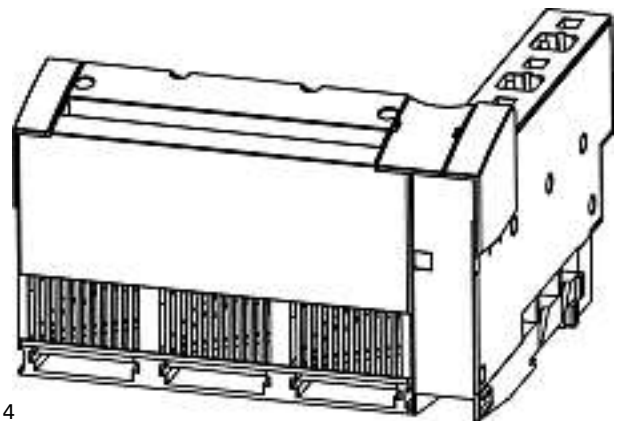

4

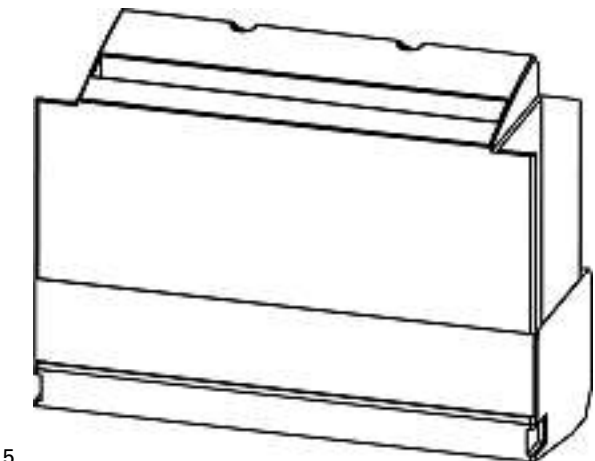

5

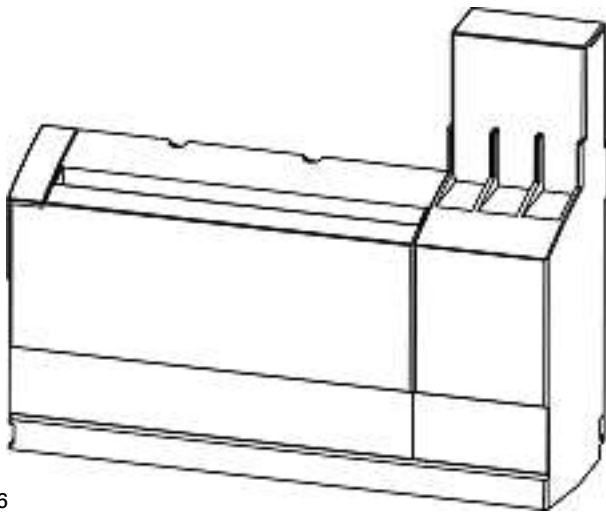

6

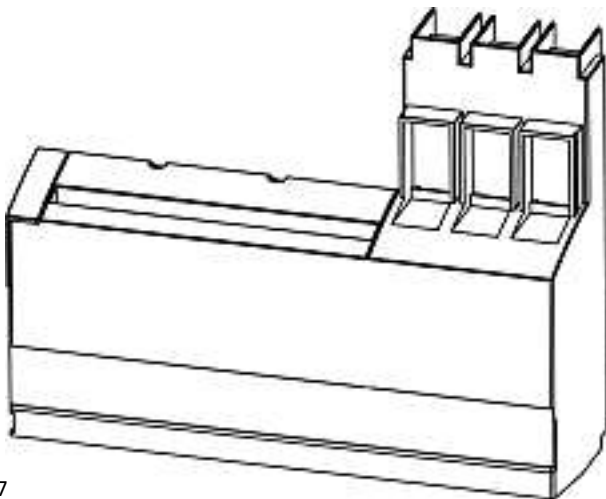
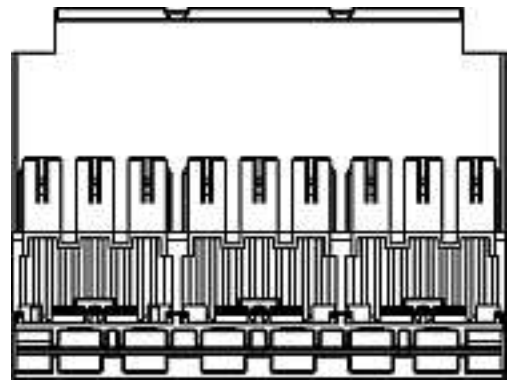

7

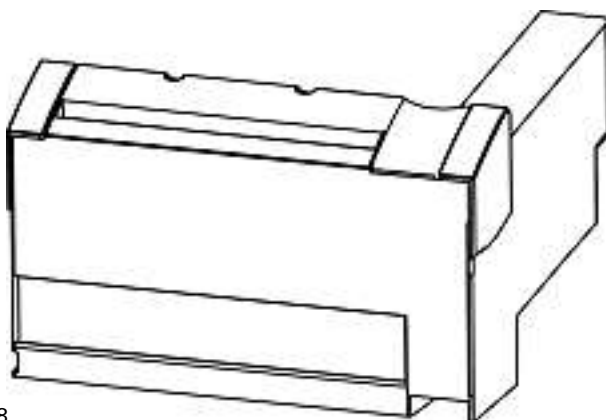
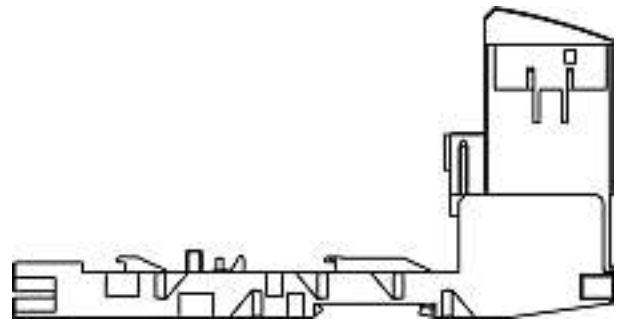
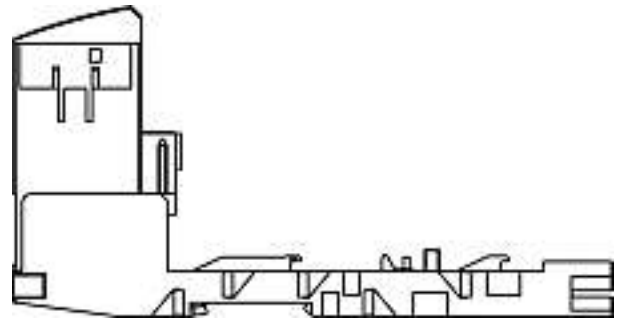

8

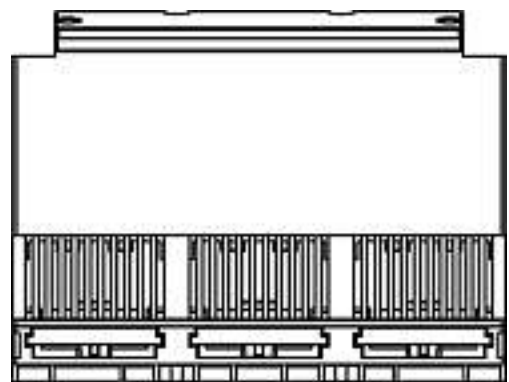

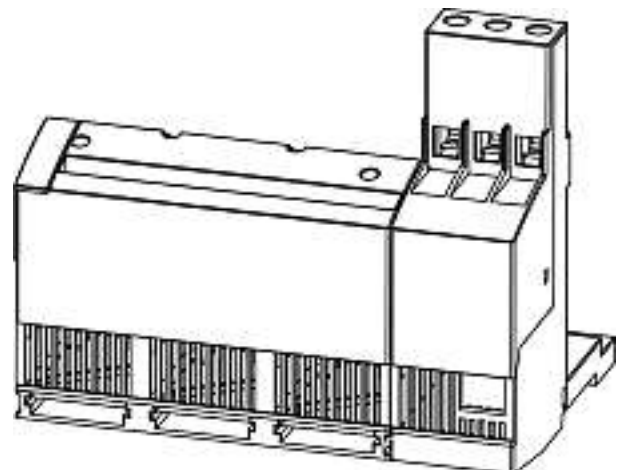
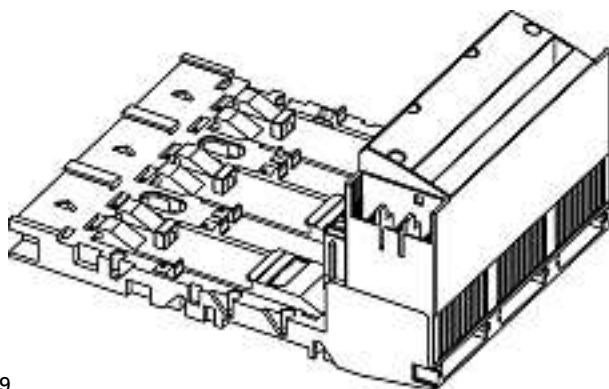
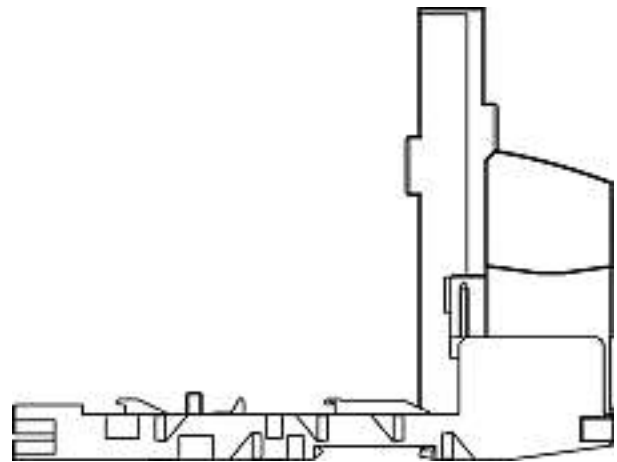
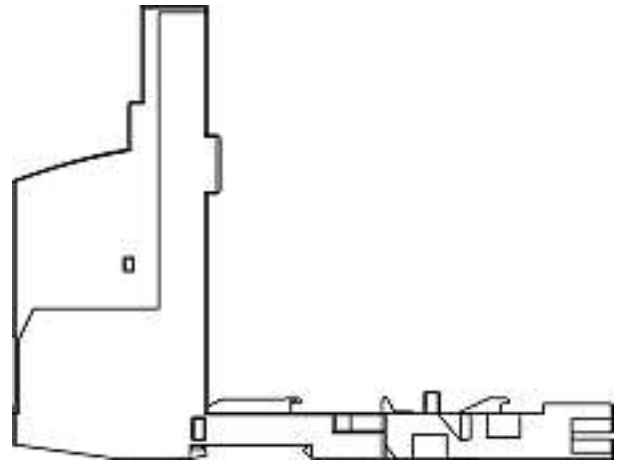
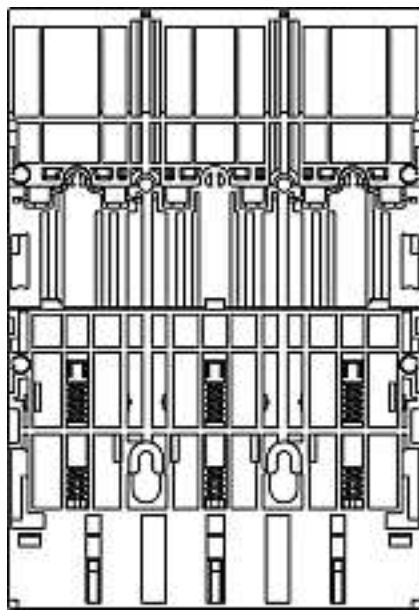
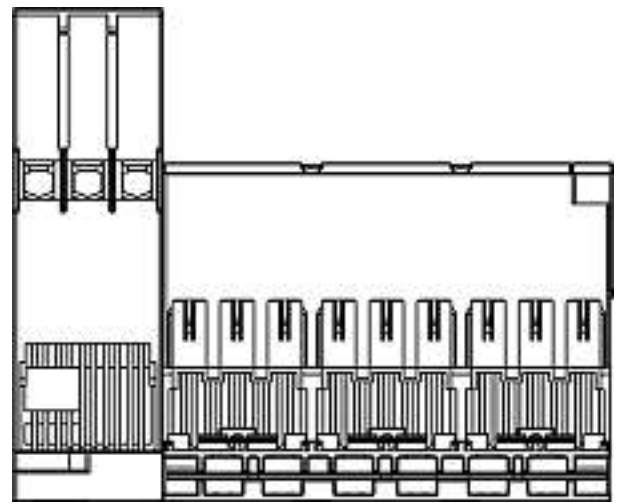
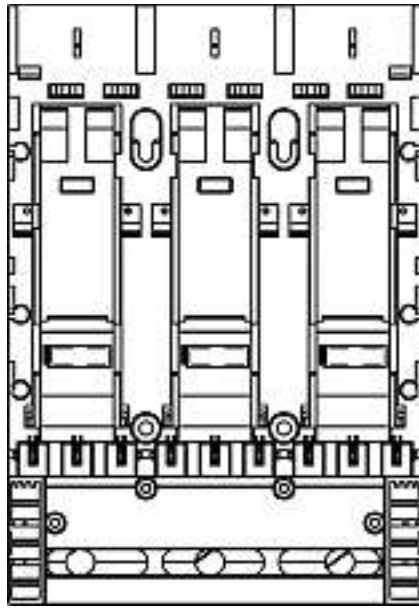

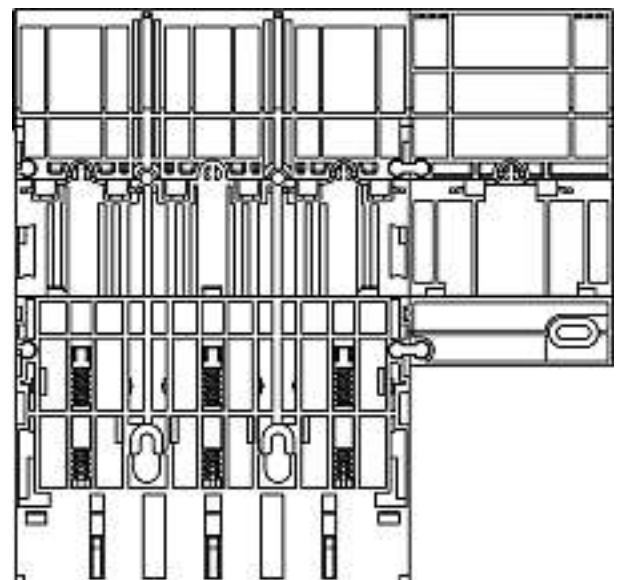
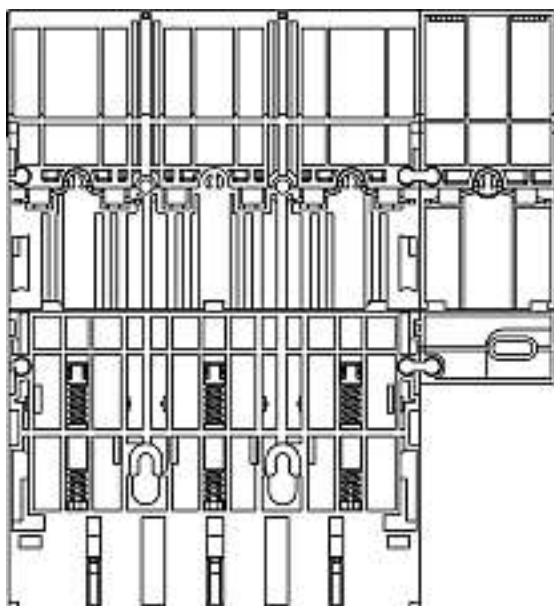
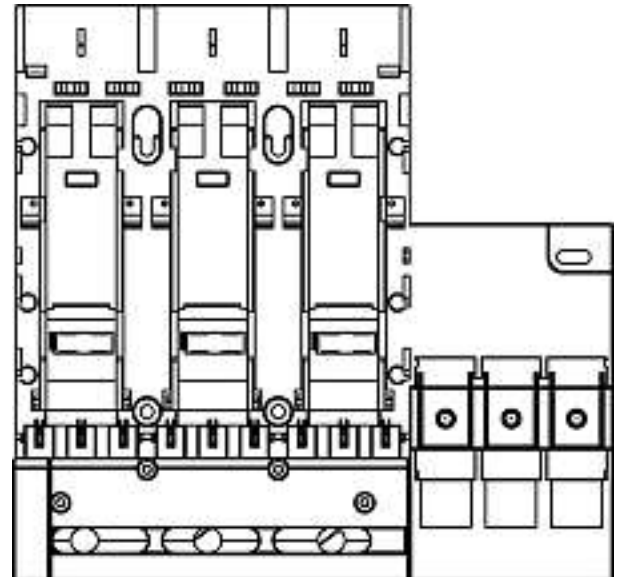
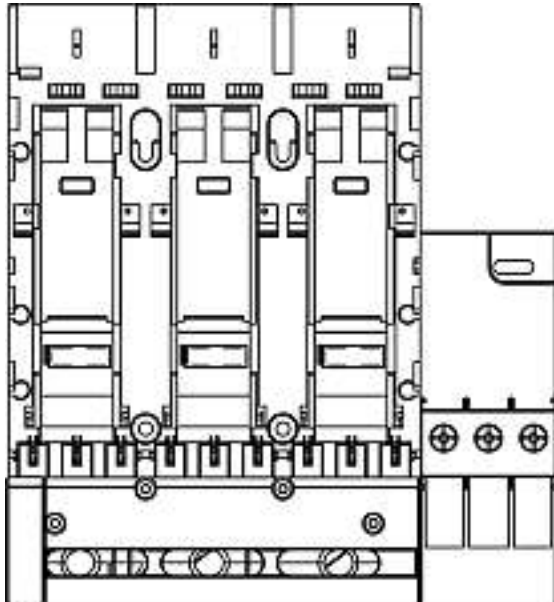
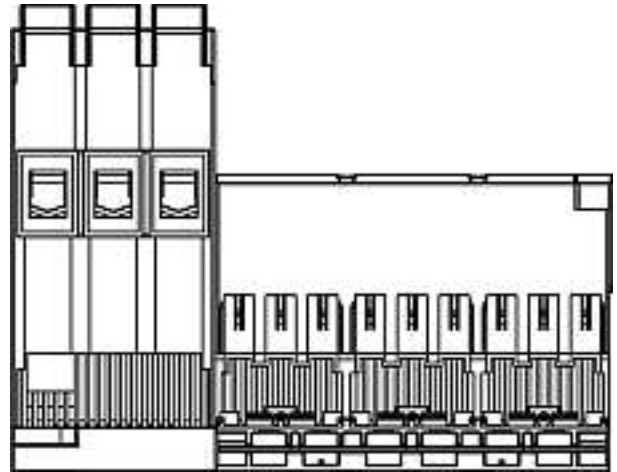
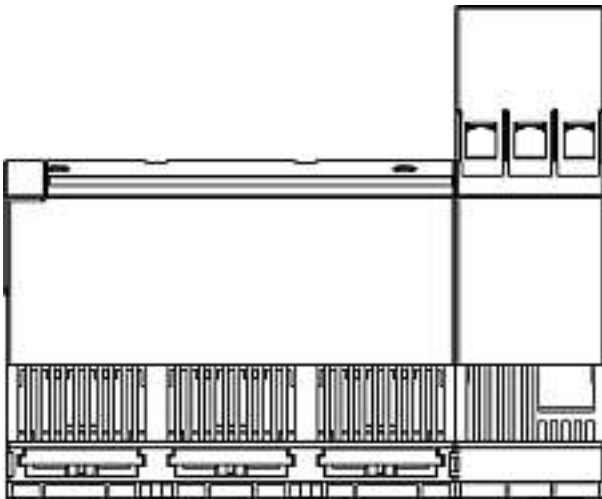

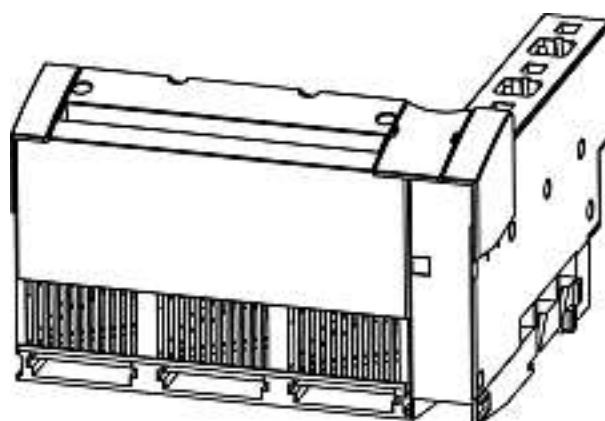
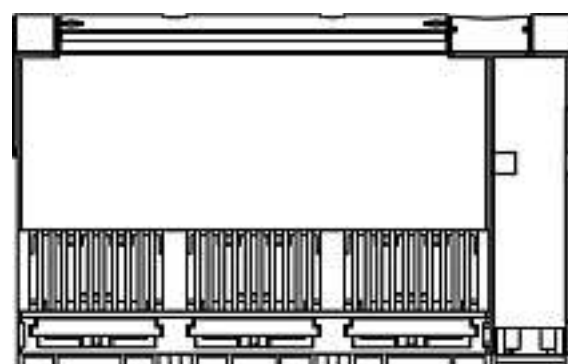
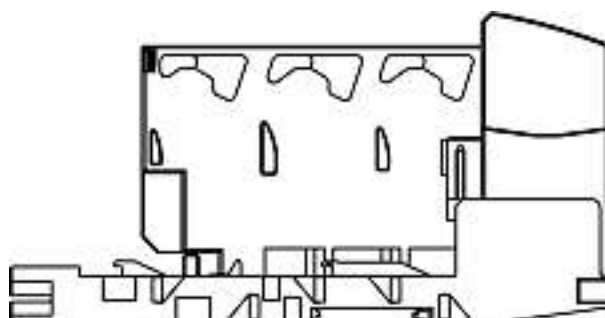
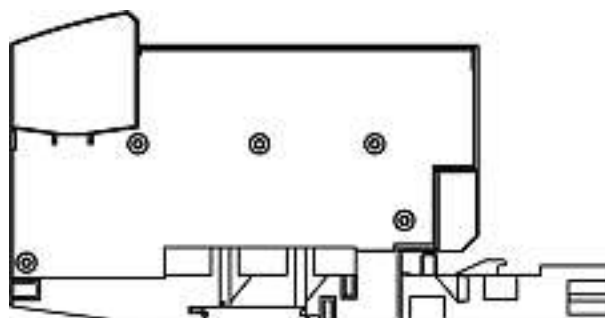
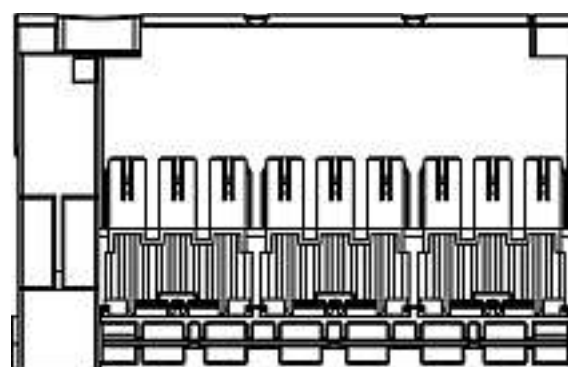
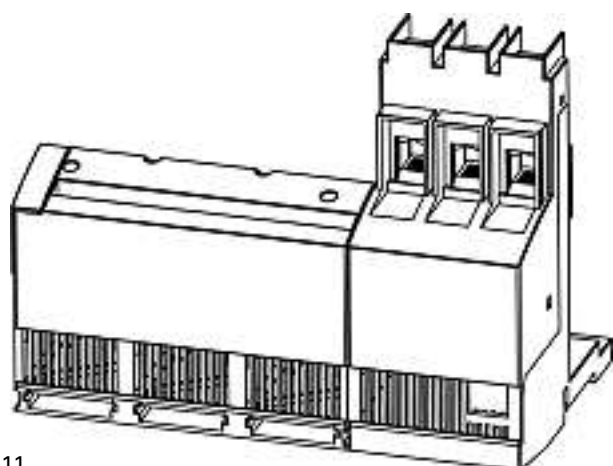
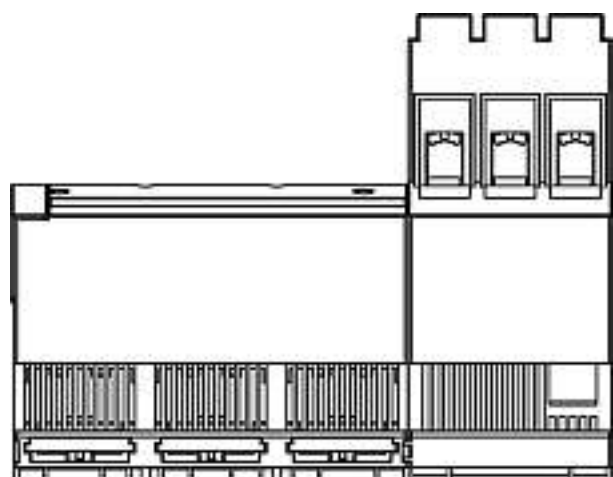
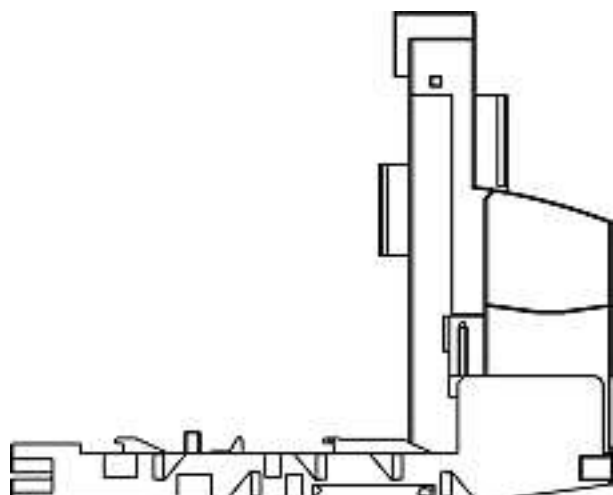
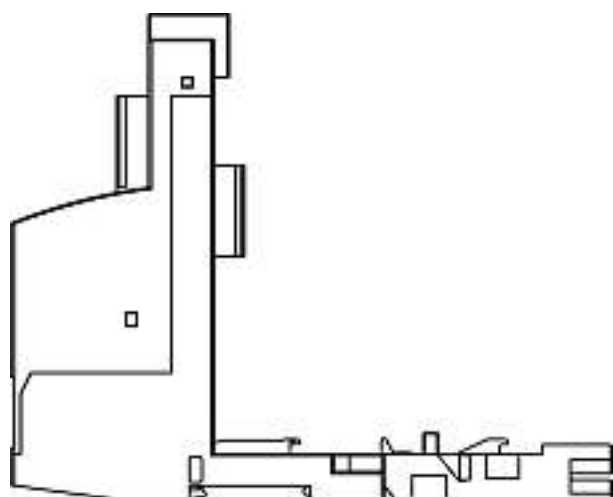

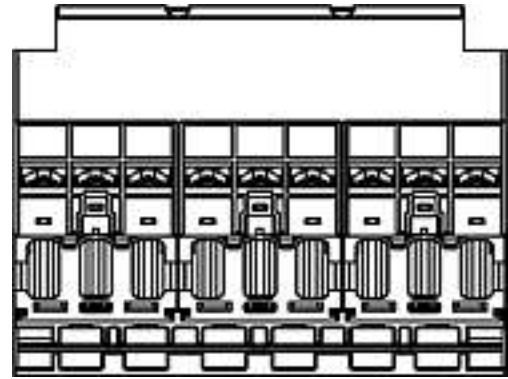
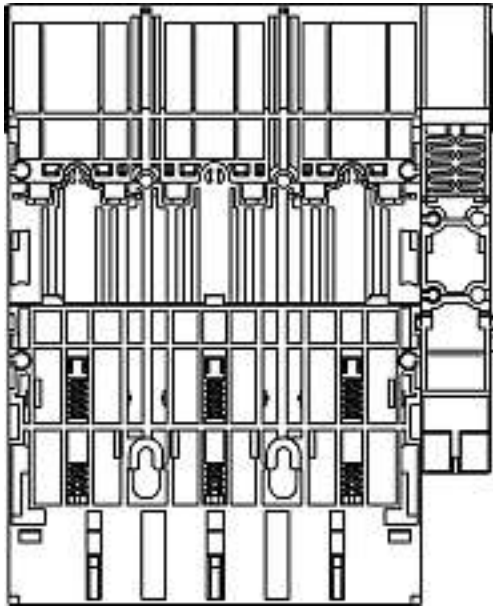
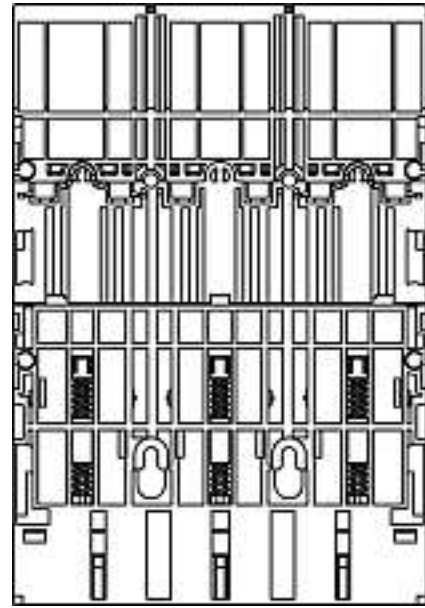
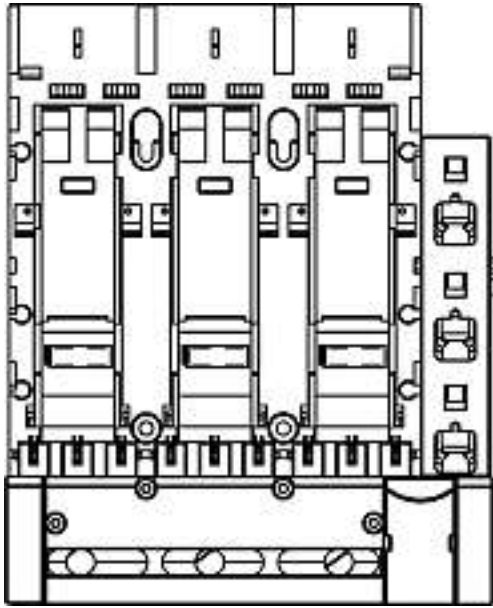

12

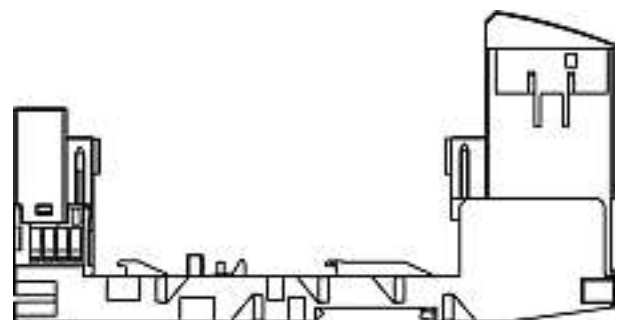
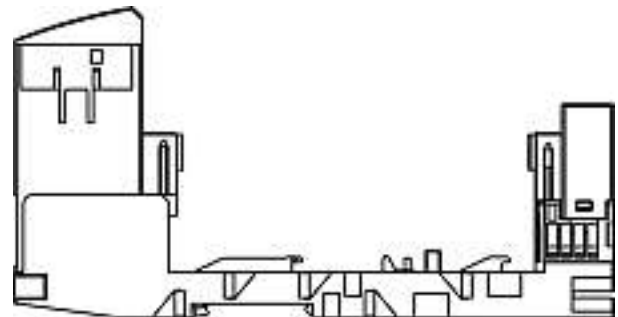
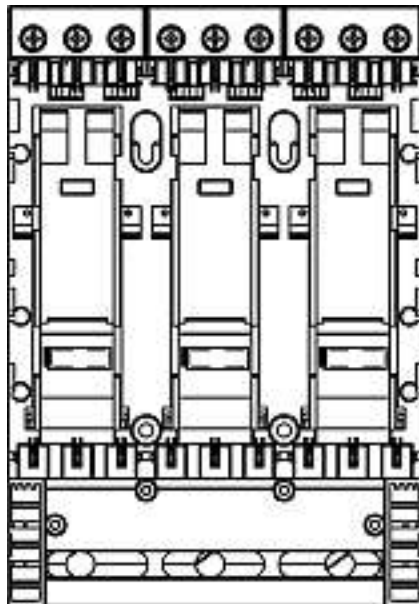

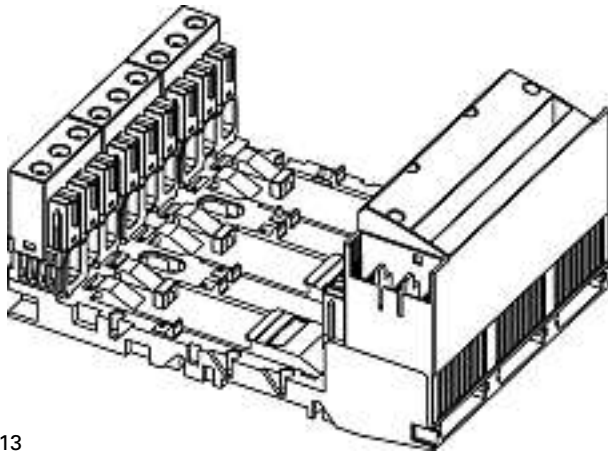
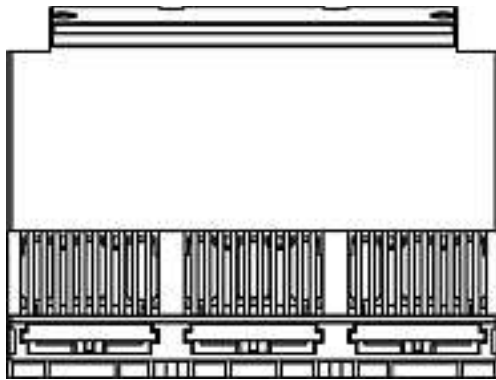

13

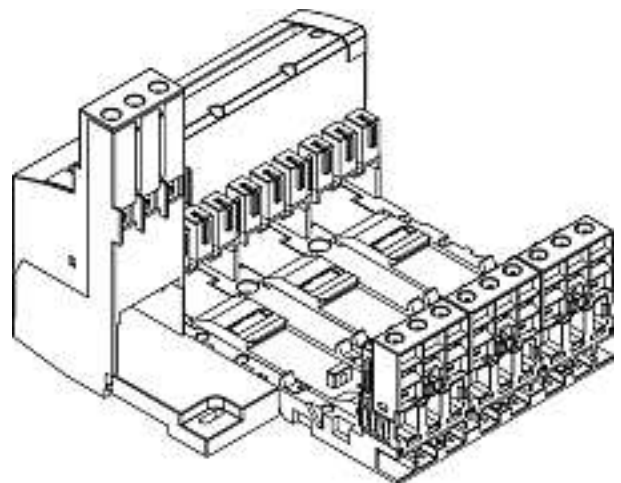
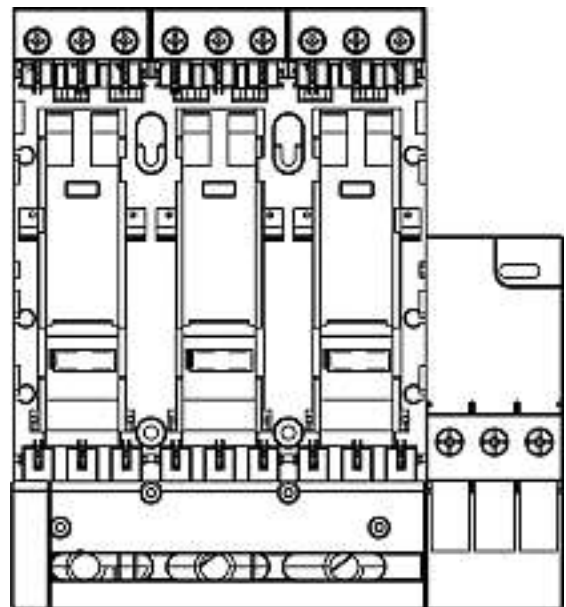
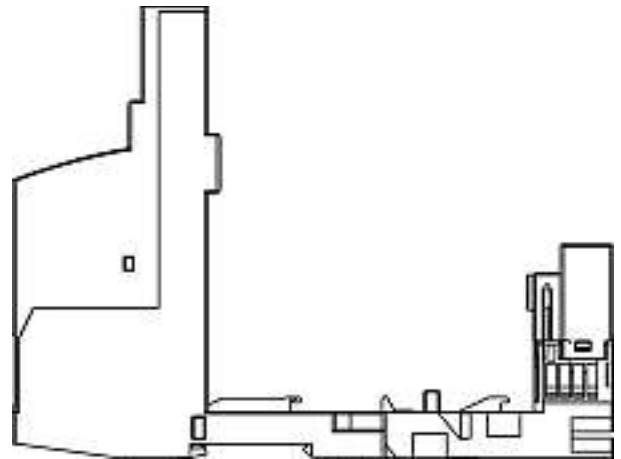
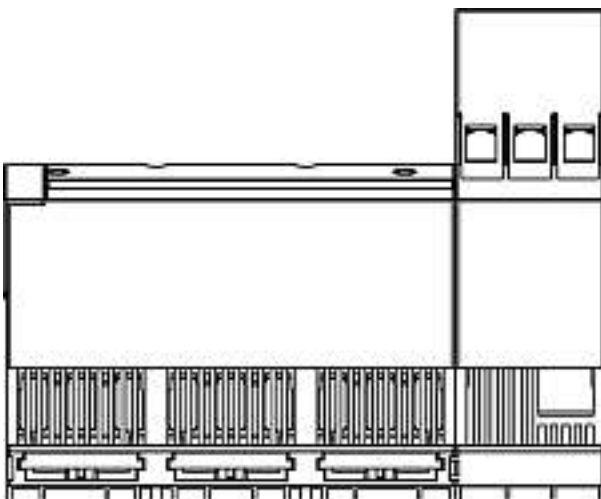
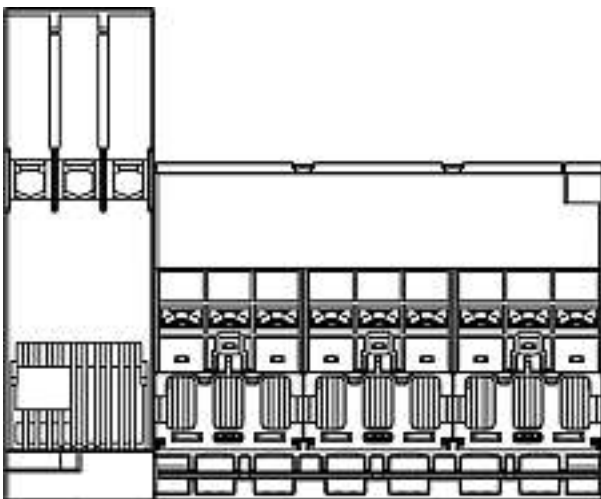

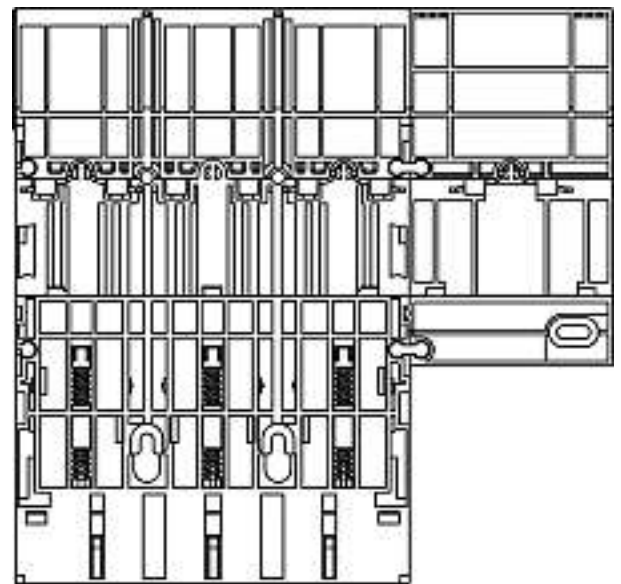
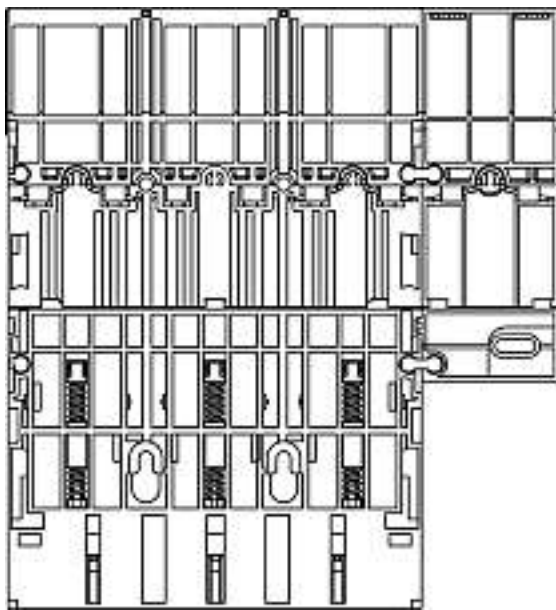
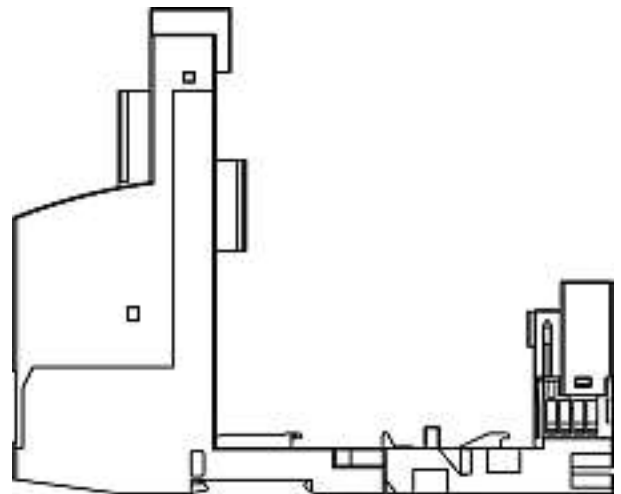
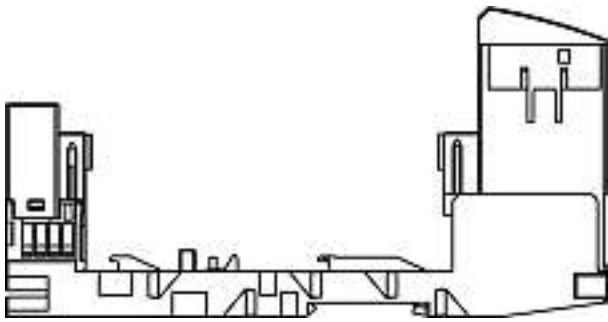

14

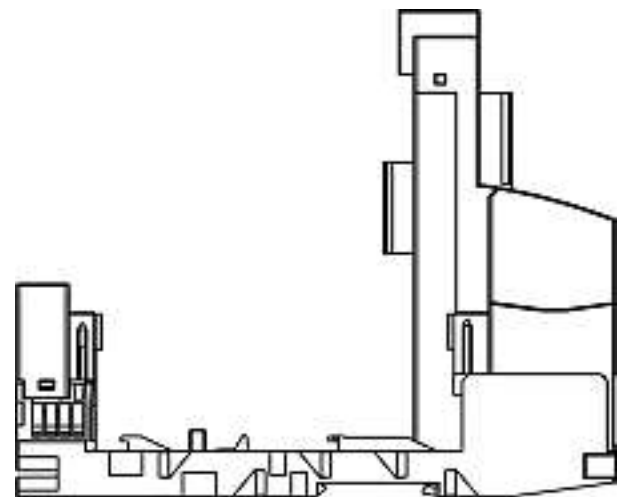
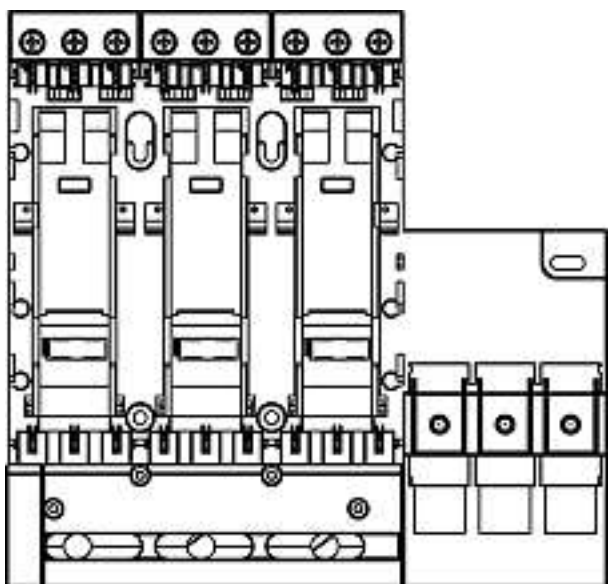

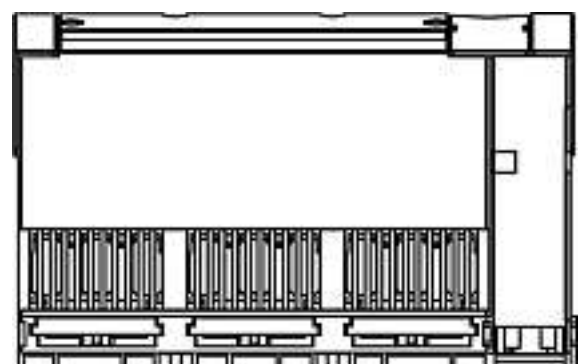
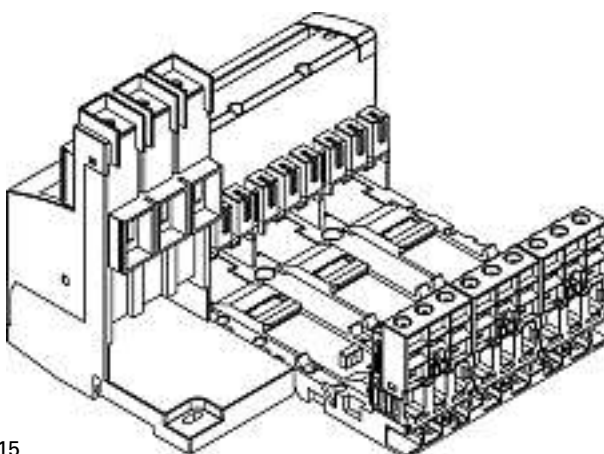
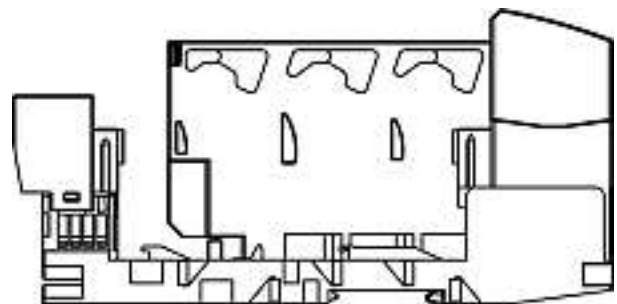
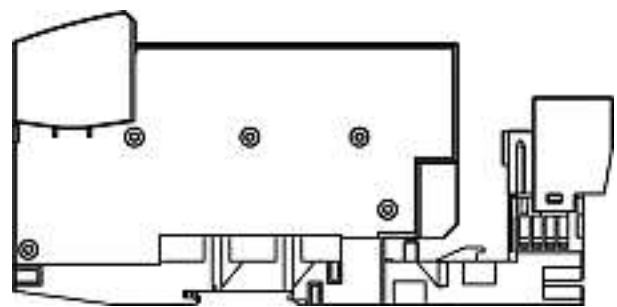
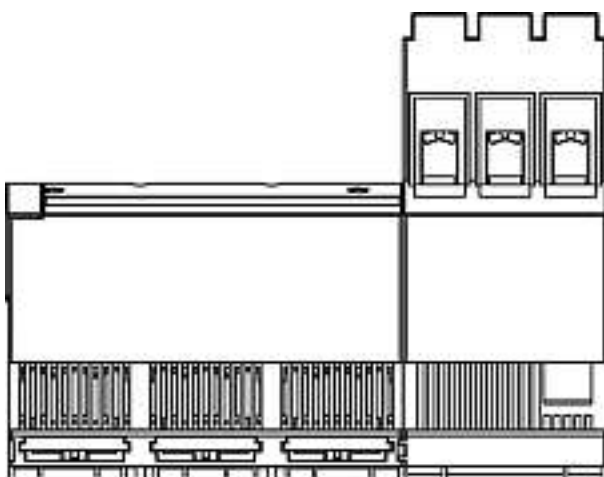
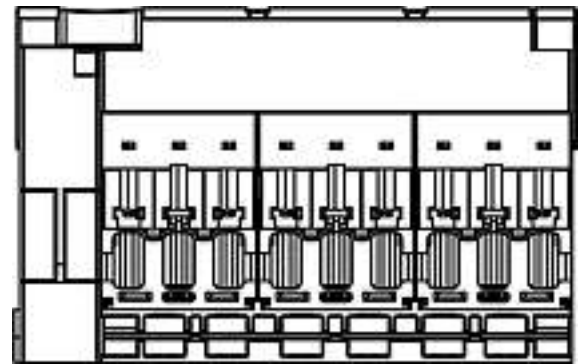
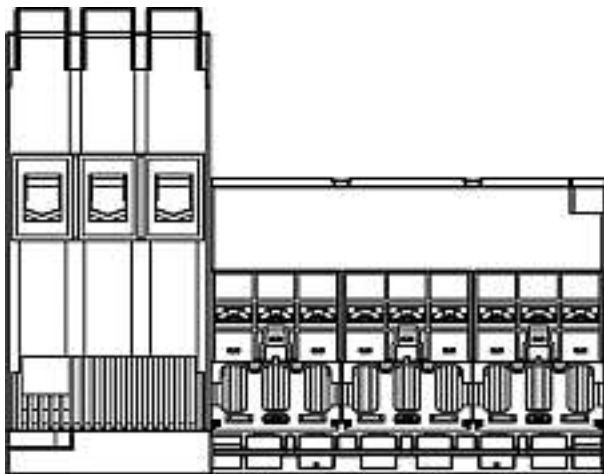

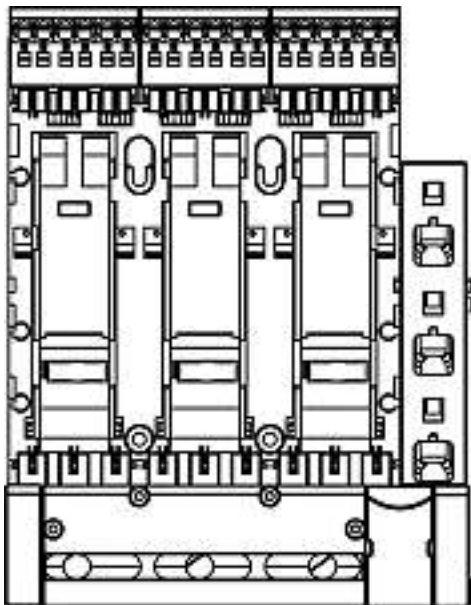

Cl. 15-07 **134 652** 18.12.2007
 2 design – machines et appareils de réfrigération
 Déposant: Société des Produits Nestlé SA, 1800 Vevey
 Designer: Emmanuel Bourrousse, Beauvais
 Mandataire: Nestec S.A., 1800 Vevey
 FL 69942-1 (siehe Farbteil Heftmitte)
 FL 69942-2 (siehe Farbteil Heftmitte)

Cl. 15-09 **134 653** 11.12.2007
 4 design – presse à découper
 Déposant: BOBST S.A., Route des Flumeaux 50, 1008 Prilly
 Designer: Christophe Kosciolk, Prévèrenge; Antonio Longo, Grandvaux
 DMB02-01 (siehe Farbteil Heftmitte)
 DMB02-02 (siehe Farbteil Heftmitte)
 DMB02-03 (siehe Farbteil Heftmitte)
 DMB02-04 (siehe Farbteil Heftmitte)

Cl. 15-09 **134 654** 11.12.2007
 5 design – capot pour presse à découper
 Déposant: BOBST S.A., Route des Flumeaux 50, 1008 Prilly
 Designer: Christophe Kosciolk, Prévèrenge; Antonio Longo, Grandvaux
 DMB03-01 (siehe Farbteil Heftmitte)
 DMB03-02 (siehe Farbteil Heftmitte)
 DMB03-03 (siehe Farbteil Heftmitte)
 DMB03-04 (siehe Farbteil Heftmitte)
 DMB03-05 (siehe Farbteil Heftmitte)

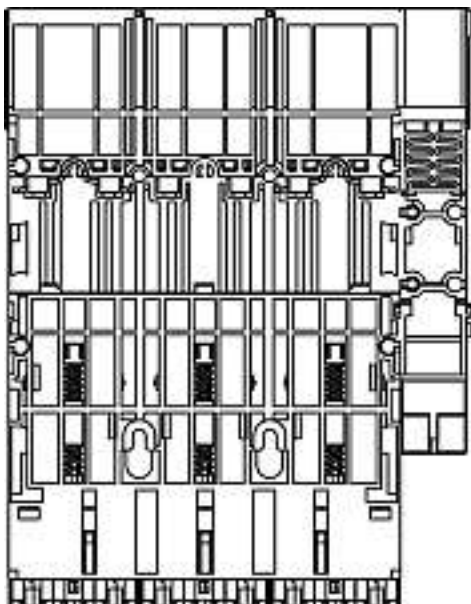

Cl. 19-08 **134 655** 10.12.2007
 2 Design – Druckvorlagen
 Hinterleger: Michael Bono, Glattalstrasse 112, 8052 Zürich



Skyline Zürich



Skyline Bern

Cl. 19-08 **134 656** 11.12.2007
 1 design – étiquette
 Déposant: Chai du Baron SA, Rue de la Manufacture 4, Case Postale 70, 1967 Bramois
 Designer: Xavier de Werra, Sion



Don Javier

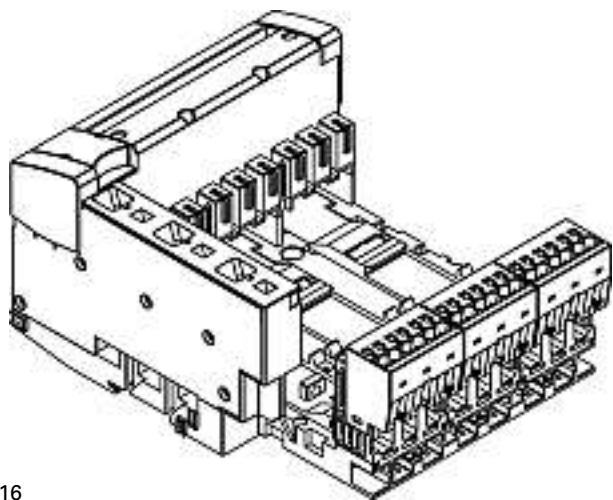

Cl. 19-08 134 657 11.12.2007
 1 design – étiquette
 Déposant: Chai du Baron SA, Rue de la Manufacture 4,
 Case Postale 70, 1967 Bramois
 Designer: Xavier de Werra, Sion



Don Quijote

Cl. 19-08 134 658 17.12.2007
 2 Design – Etiketten
 Hinterleger: Pavin AG, Industriestrasse 26, 8404 Winterthur
 Designer: Claudio Pavin, Aadorf



Prosecco di Valdobbiadene DOC



Prosecco di Valdobbiadene DOC Millesimato

Cl. 19-08 134 659 07.01.2008
 1 design – imprimé
 Déposant: Société des Produits Nestlé SA, 1800 Vevey
 Designer: Béatrice Mariotti, Paris
 Mandataire: Nestec S.A., 1800 Vevey

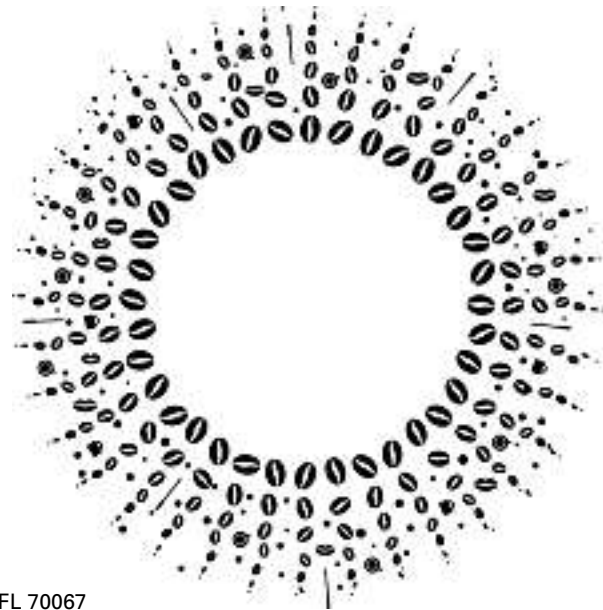

FL 70067

Cl. 19-08 134 660 07.01.2008
 1 design – imprimé
 Déposant: Société des Produits Nestlé SA, 1800 Vevey
 Designer: Béatrice Mariotti, Paris
 Mandataire: Nestec S.A., 1800 Vevey



FL 70068

Cl. 20-02 134 661 14.12.2007
 1 Design – Verkaufsständer
 Hinterleger: Bruno Messerli, Hauptstrasse 106, 4587 Aetingen
 Vertreter: Schluep | Degen Rechtsanwälte, 3012 Bern

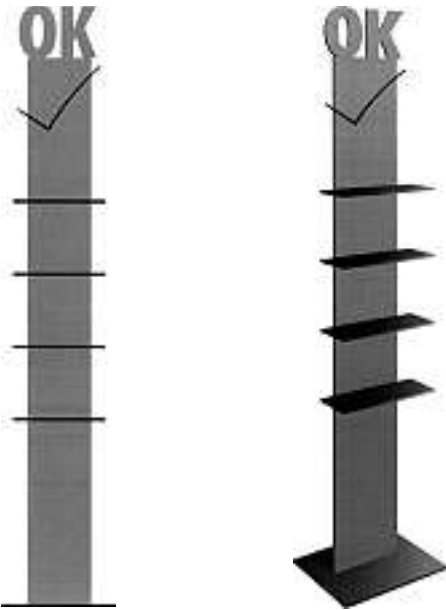

651674/Cs/cb

Cl. 20-02 134 662 16.12.2007
 2 Design – Steller
 Hinterleger: Bruno Messerli, Hauptstrasse 106, 4587 Aetingen

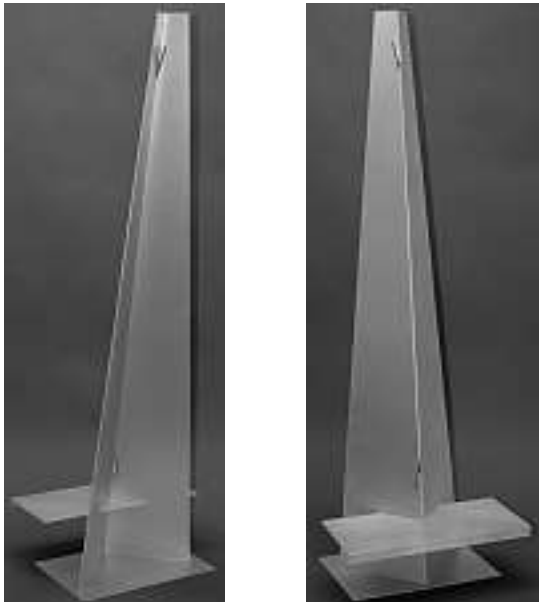

Plakathalter



Plakathalter mit Plakat

Cl. 21-01 134 663 11.12.2007
 1 Design – Spiel
 Hinterleger: Pascal Baumgartner, Alderstrasse 47,
 8008 Zürich

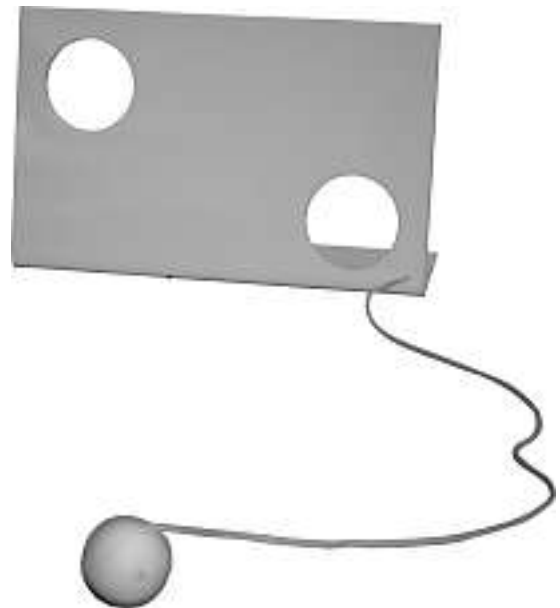

Pocket Kicker

Cl. 23-04 134 664 22.11.2007
 1 Design – Filterbeutel
 Hinterleger: ISI Industrie-Produkte GmbH, Industriepark
 Nord, 53567 Buchholz-Mendt, DE
 Designer: Lothar Mindnich, Sankt Augustin; Harald
 Hentschel, Hennef
 Vertreter: PA Aldo Römpler, 9410 Heiden
 Priorität: EM, 24.08.2007
 1 (siehe Farbteil Heftmitte)

Cl. 24-02 134 665 20.12.2007
 8 Design – Teile für Spritzen
 Hinterleger: Daikyo Seiko, Ltd., 38-2, Sumida 3-chome,
 Sumida-ku, Tokyo 131-0031, JP
 Designer: Nobuo Sudo, Tokyo; Masamichi Sudo, Tokyo;
 Hideaki Kawamura, Tokyo; Tsuyoshi Koshidaka, Tokyo
 Vertreter: A. Braun, Braun, Héritier, Eschmann AG,
 Patentanwälte, 4051 Basel
 Priorität: JP, 25.06.2007; JP, 25.06.2007; JP, 25.06.2007;
 JP, 25.06.2007; JP, 13.07.2007; JP, 13.09.2007; JP, 13.09.2007

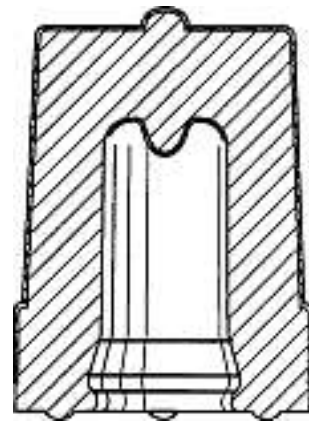
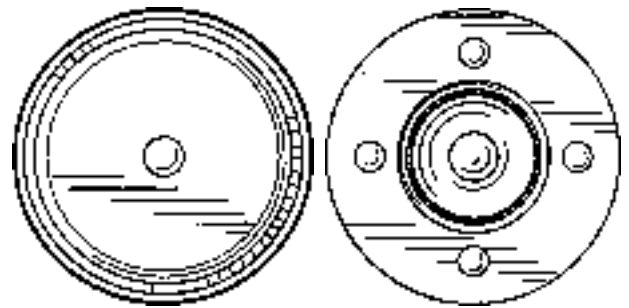
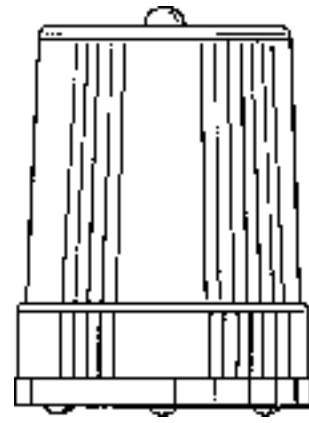
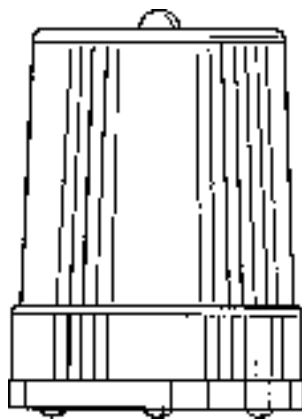
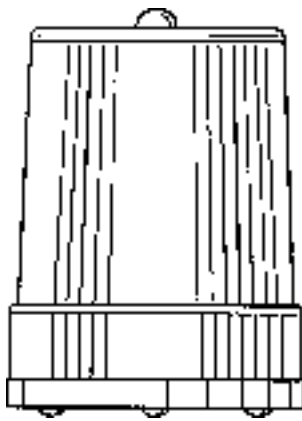
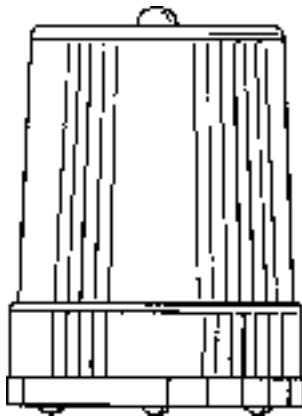
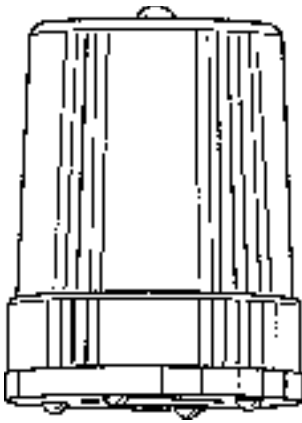

1

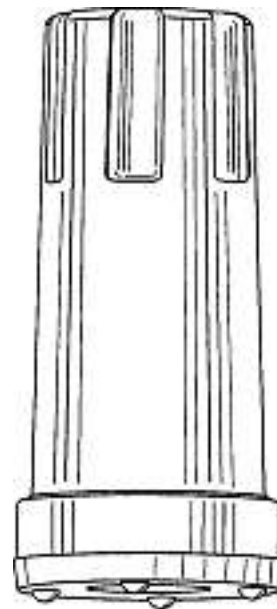

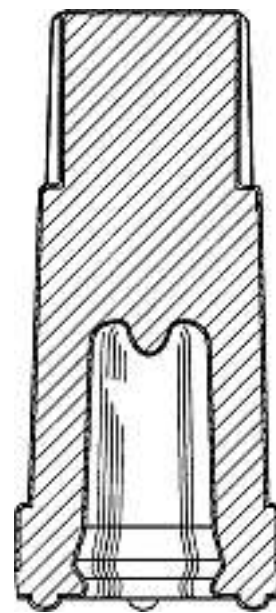
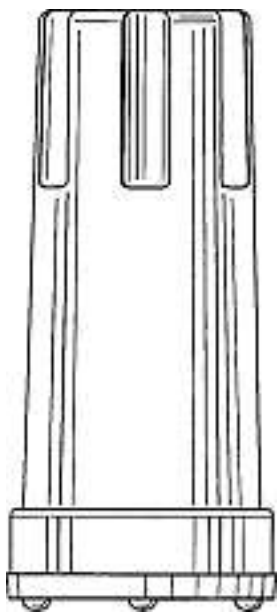
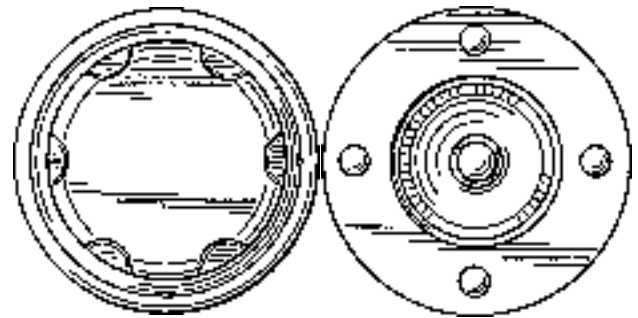
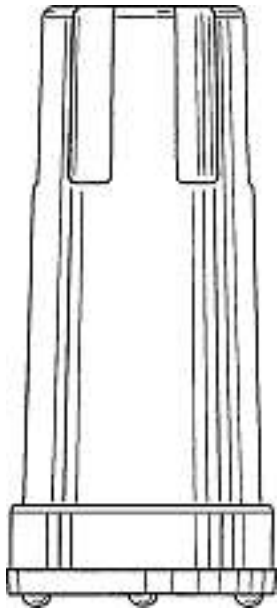
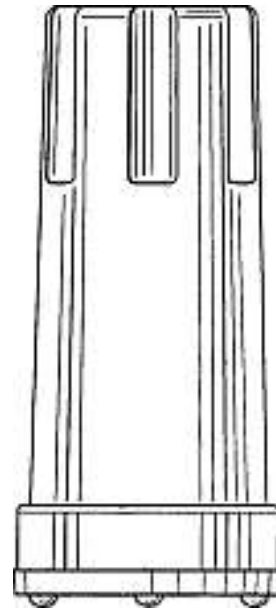
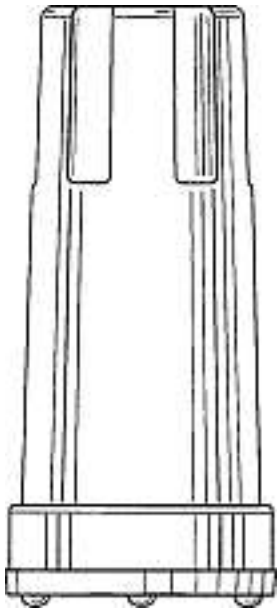

2

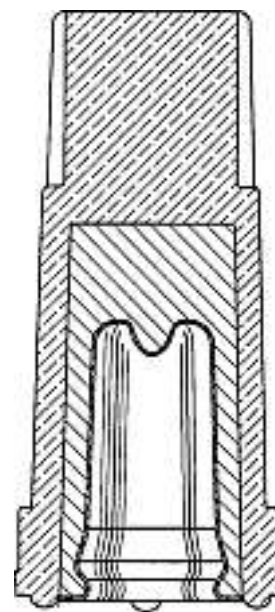
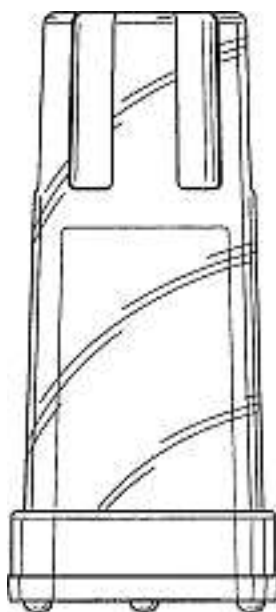
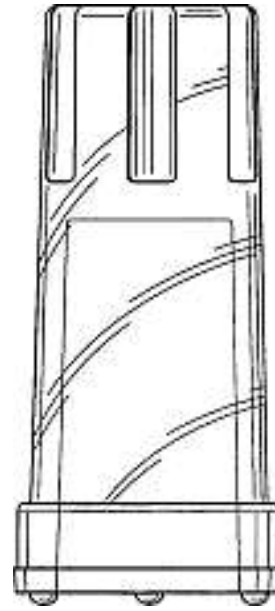
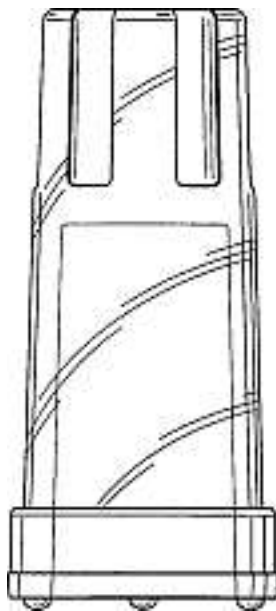
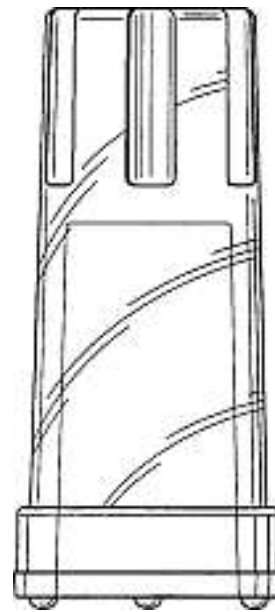
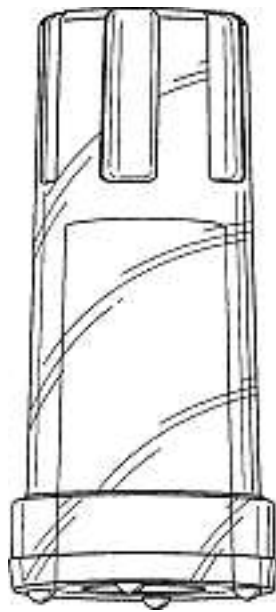

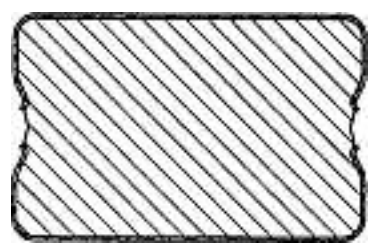
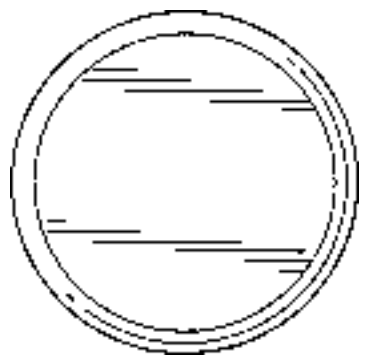
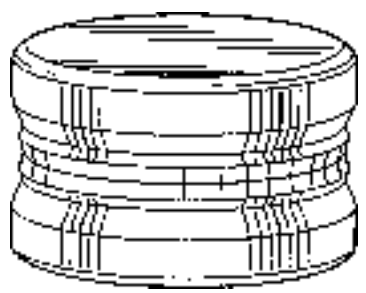
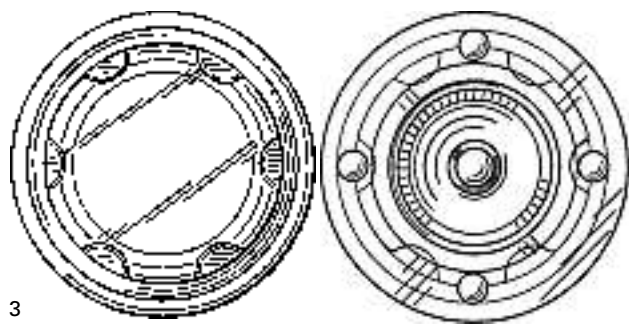

4

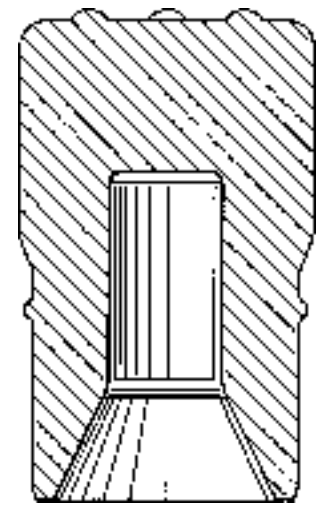
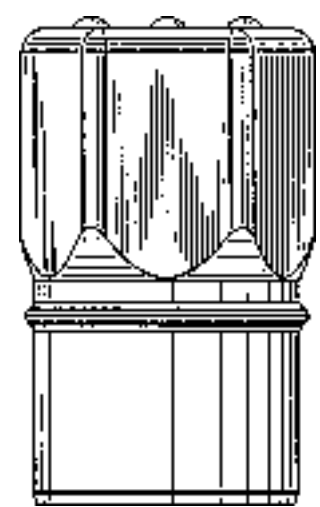
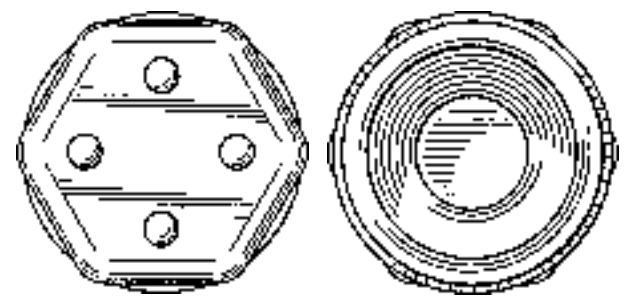
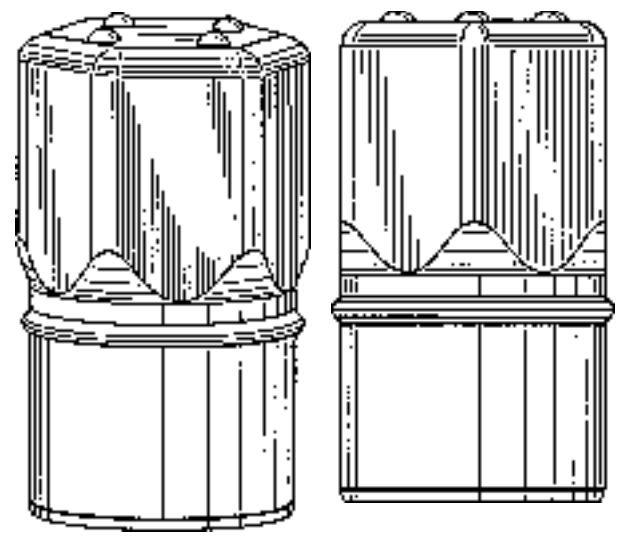

5

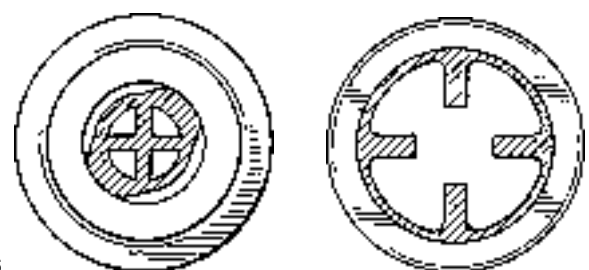
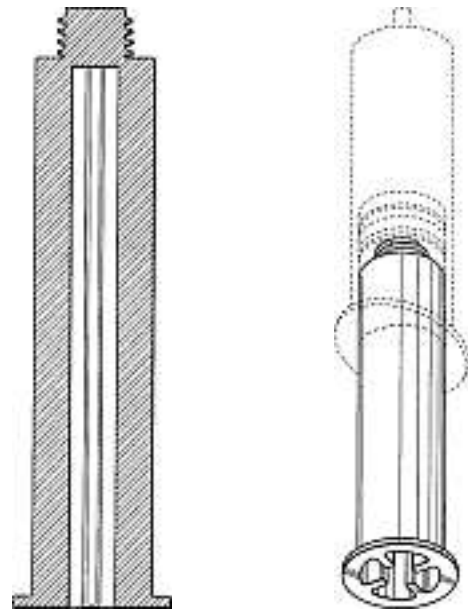
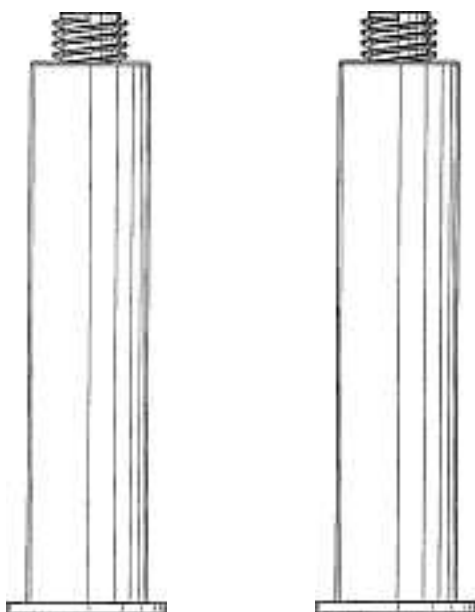
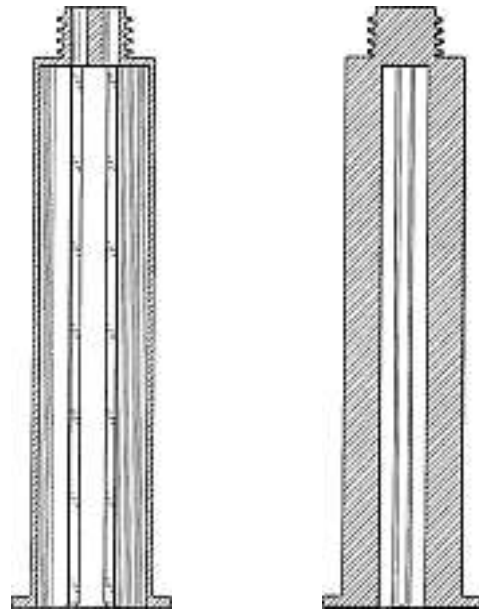
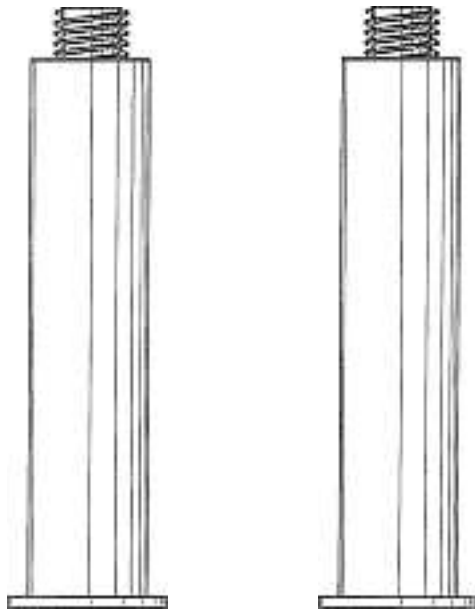
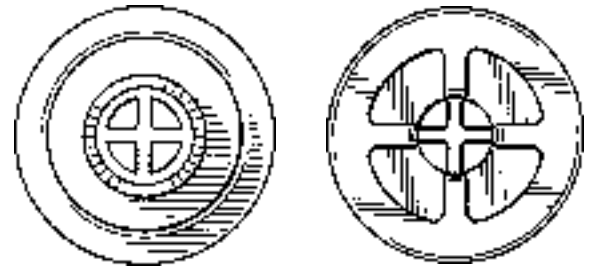
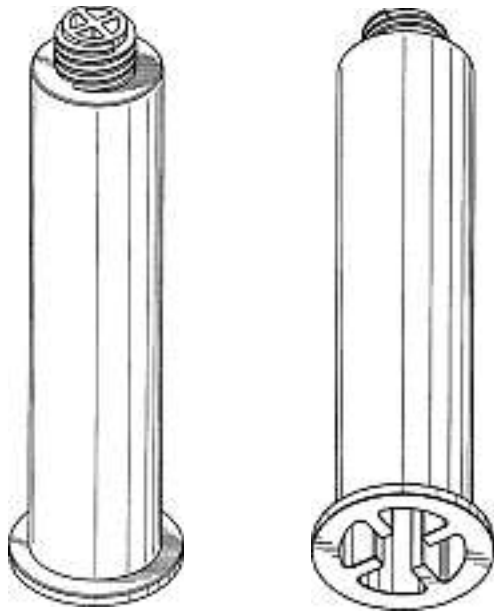

6

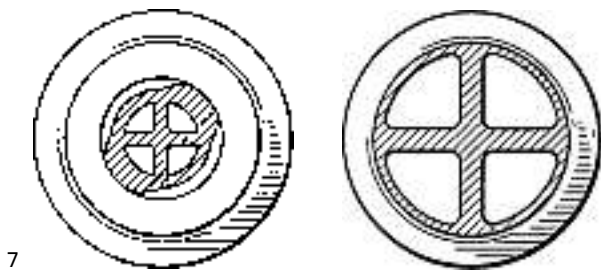

7

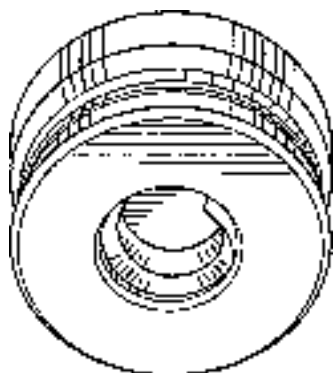
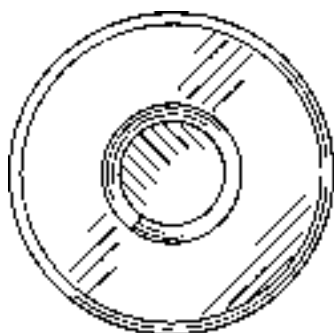
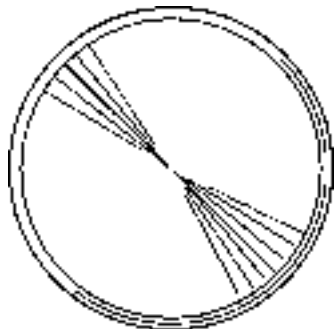
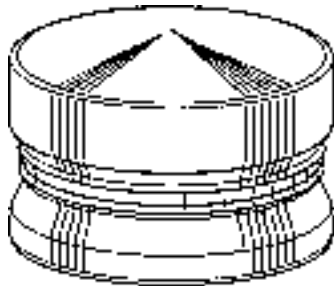

8

Cl. 26-05 **134 666** 20.12.2007
 1 Design – Reflektor
 Hinterleger: Hans-Werner Friedrich Briese, Geibelstrasse 46A, 22303 Hamburg, DE
 Vertreter: E. Blum & Co. AG, Patent- und Markenanwälte VSP, 8044 Zürich
 Priorität: EM, 29.06.2007
 1 (siehe Farbteil Heftmitte)

Cl. 26-05 **134 667** 20.12.2007
 1 Design – Leuchtenkörper
 Hinterleger: Hans-Werner Friedrich Briese, Geibelstrasse 46A, 22303 Hamburg, DE
 Vertreter: E. Blum & Co. AG, Patent- und Markenanwälte VSP, 8044 Zürich
 Priorität: EM, 04.07.2007
 1 (siehe Farbteil Heftmitte)

Cl. 30-03 **134 669** 30.11.2007
 2 Design – Futternapf
 Hinterleger: Ernst Schausberger & Co. GmbH, Heidestrasse 19, 4623 Günskirchen, AT
 Designer: Walter Demelbauer, Günskirchen
 Vertreter: KRSW WEINMANN, 8032 Zürich
 Priorität: EM, 25.10.2007; EM, 25.10.2007



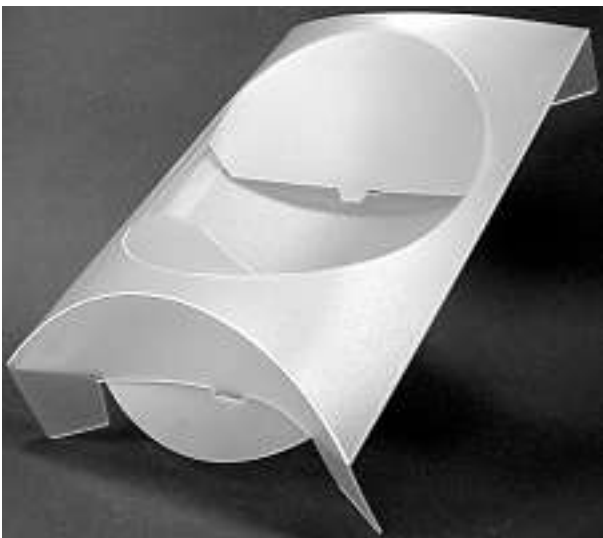
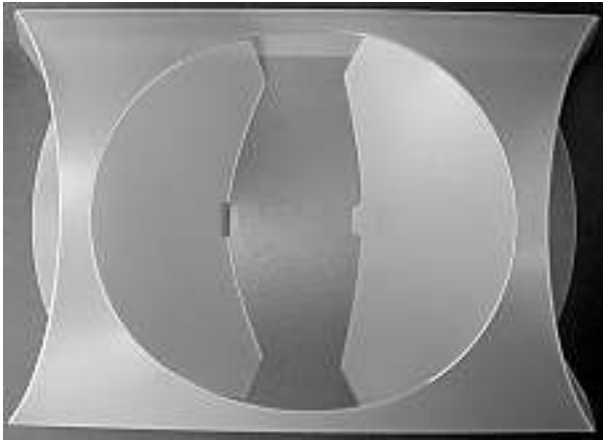

1

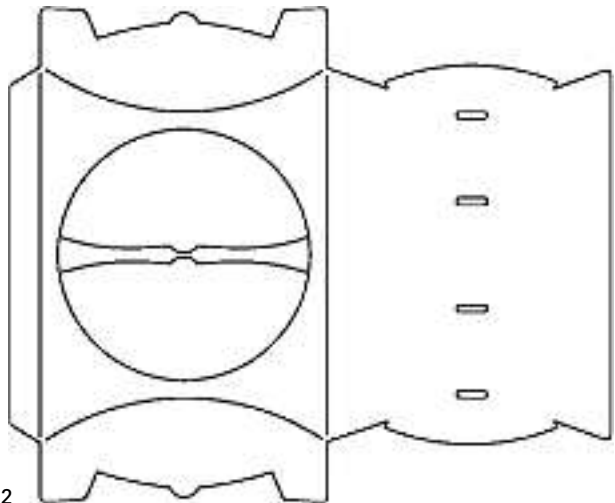

2

Cl. 30-99 **134 670** 18.12.2007
 1 Design – Kauknochen
 Hinterleger: Mars, Incorporated, A Delaware Corporation, 6885 Elm Street, McLean/VA, US
 Designer: Emine Unlu, Pasadena; Jose Barba, El Monte; Oscar Ortiz, Hawthorne; Peter Slusarczyk, Bolton; Allan Torney, Brampton; Liisa Mooney, Toronto
 Vertreter: A.W. Metz & Co. AG, 8024 Zürich
 Priorität: US, 10.07.2007

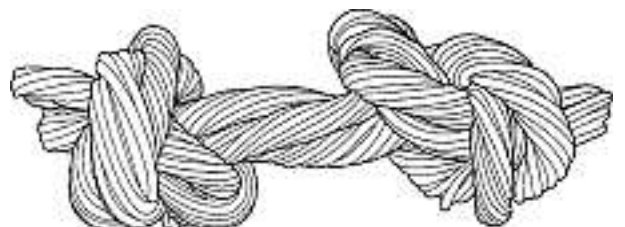
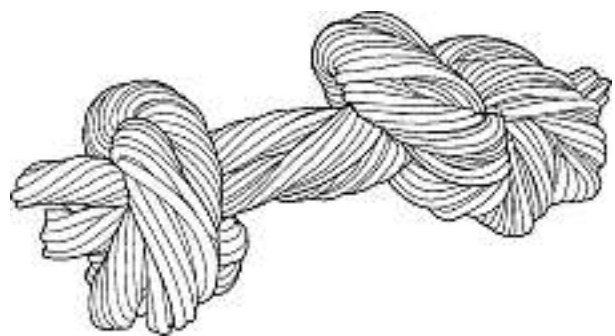

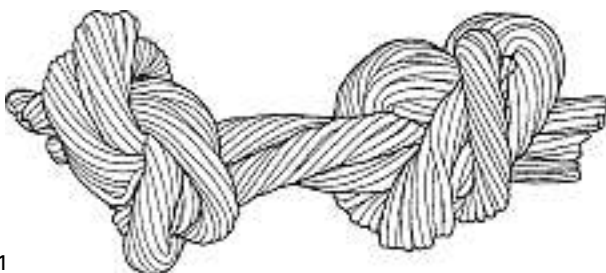
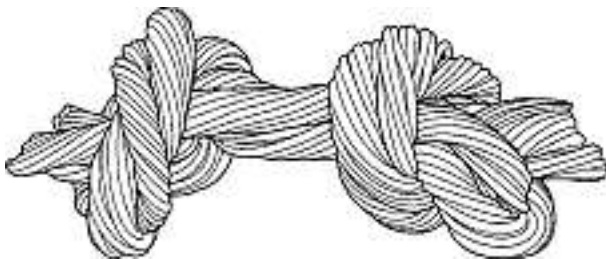
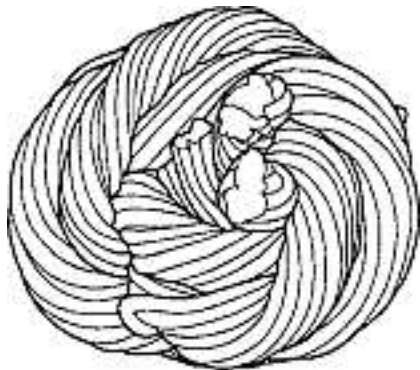
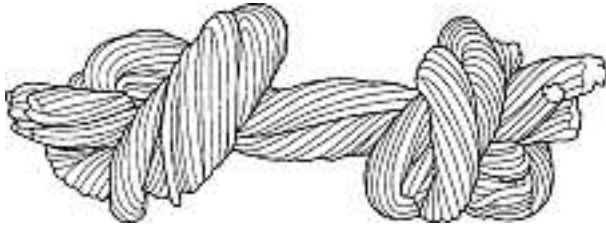
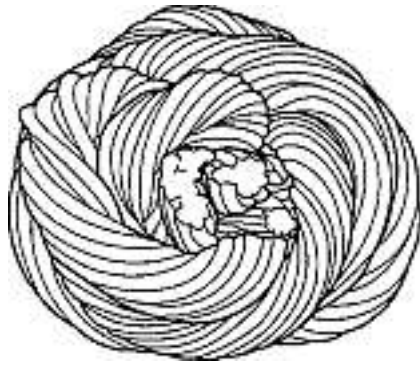

1

**Verlängerungen
Prolongations
Prolongazioni**

116 558 Cl. 10-02 1 Design

120 346 Cl. 09-01 10 Design

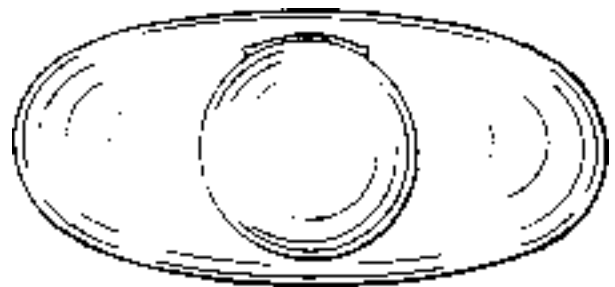

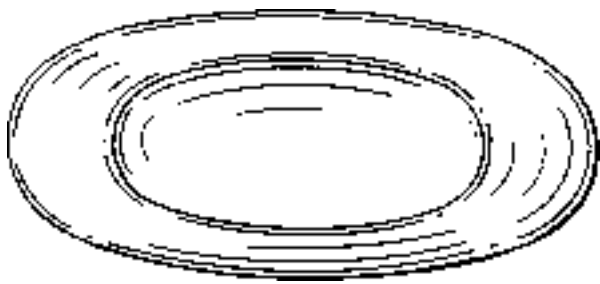

1



2

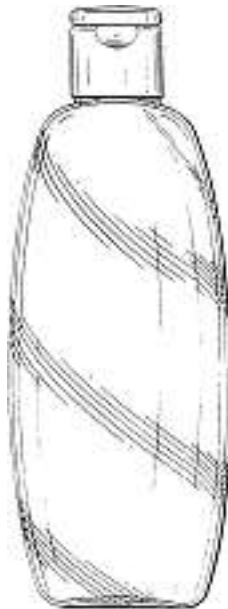
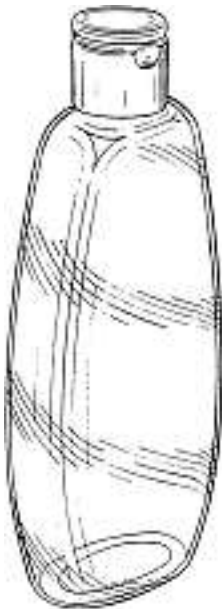

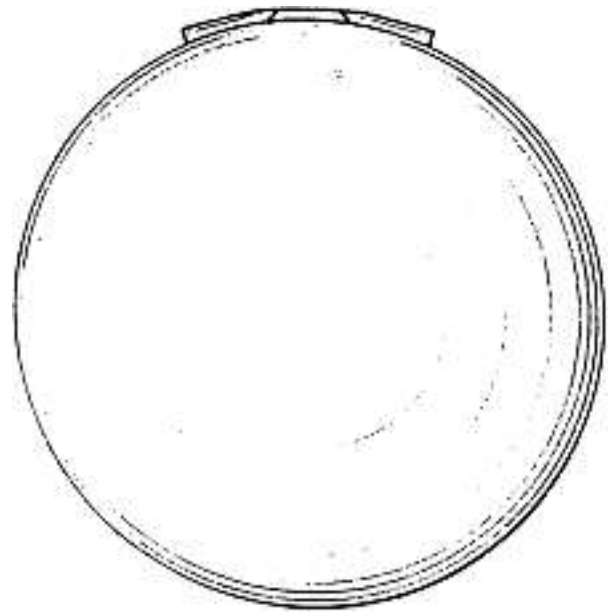
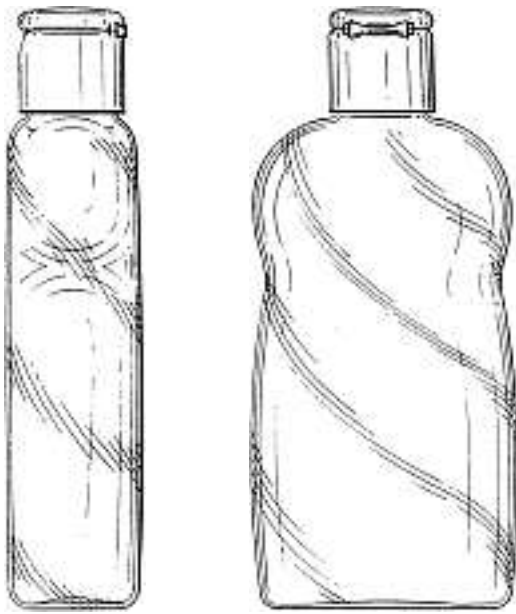

3

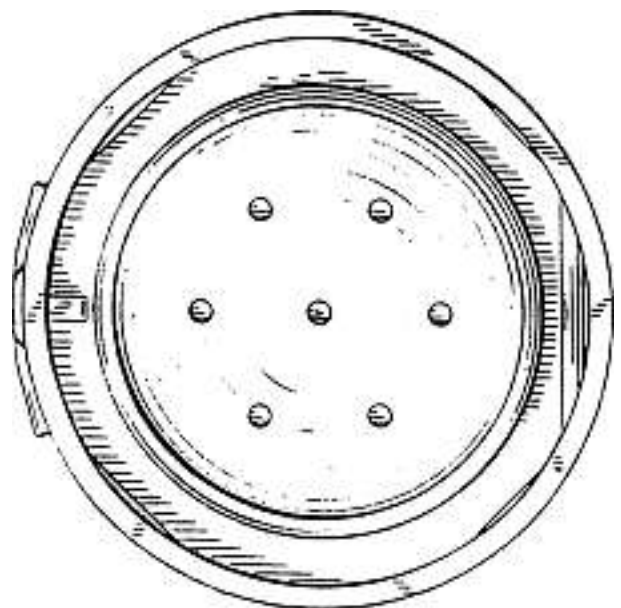
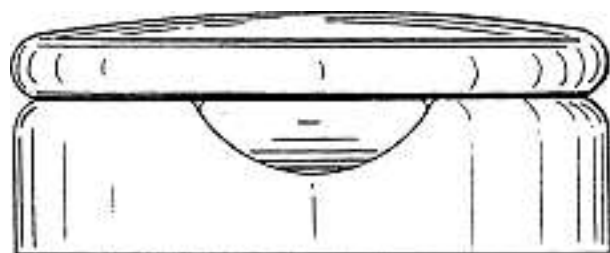
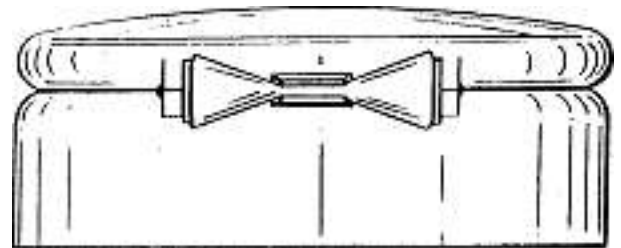
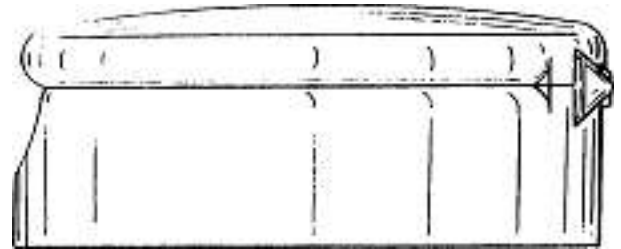



4

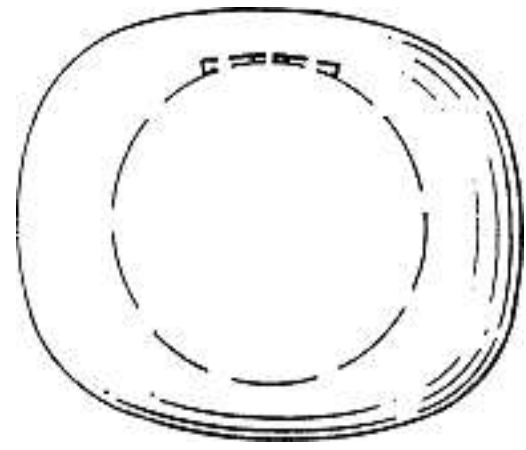

5

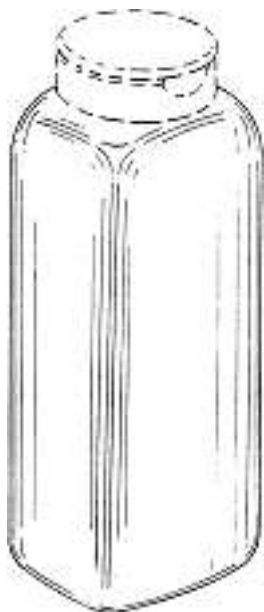
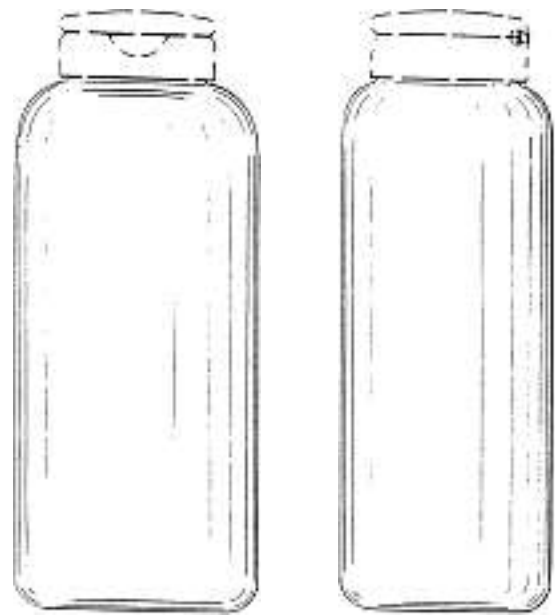

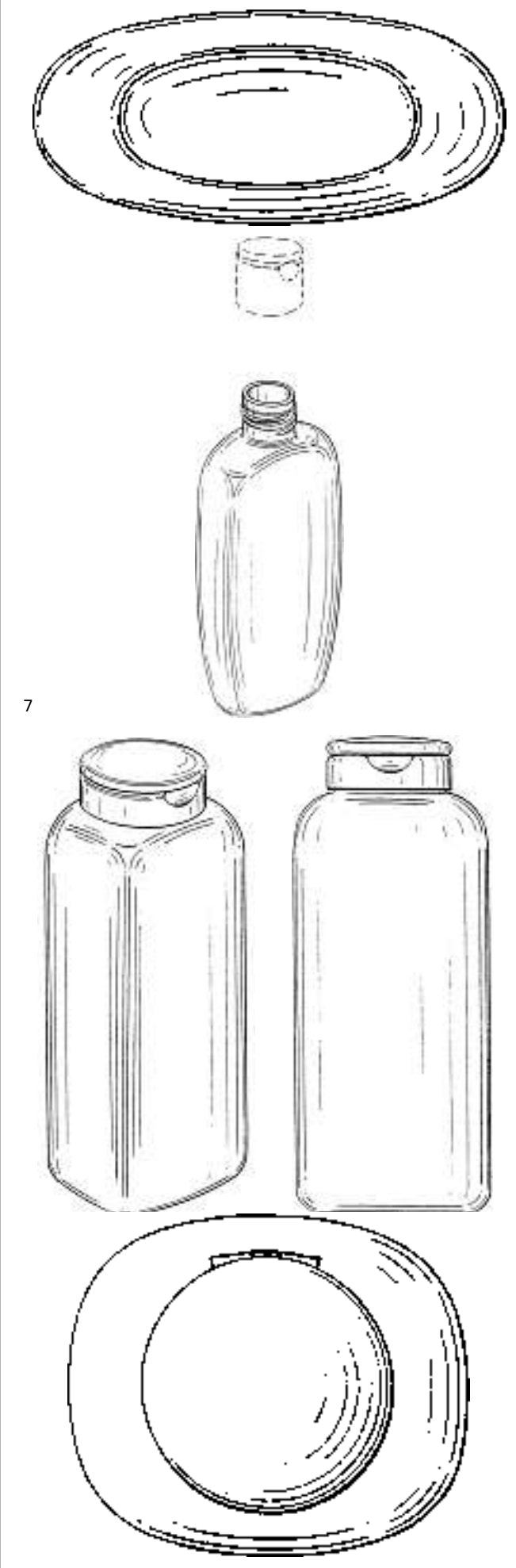
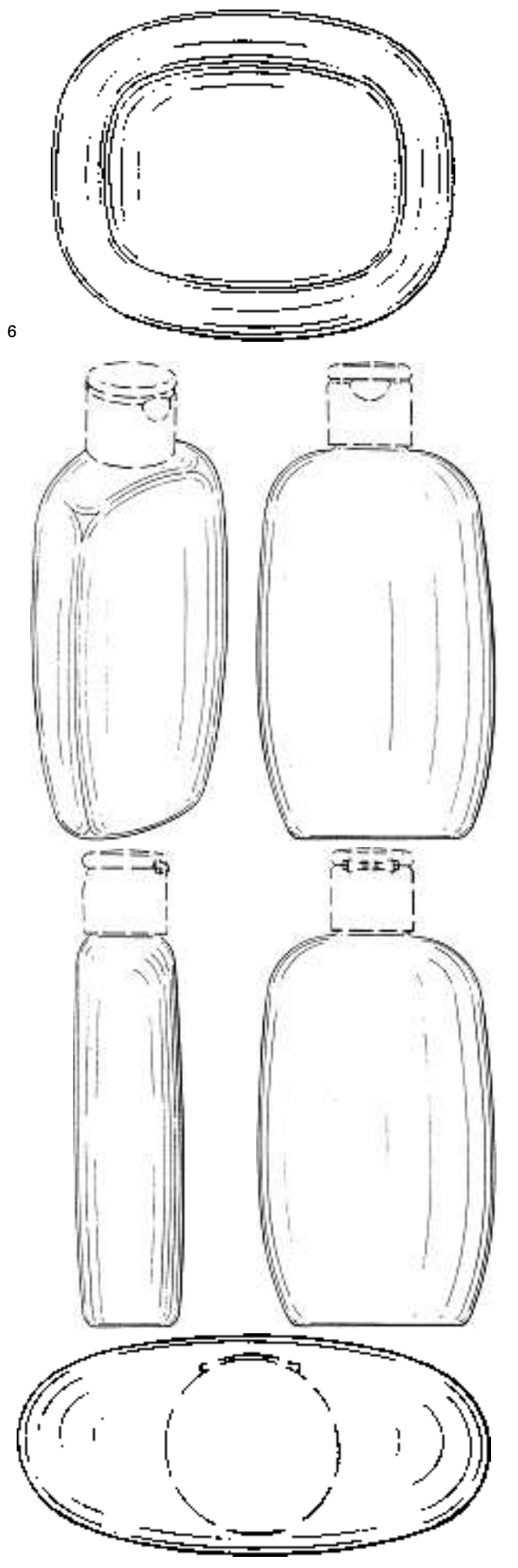

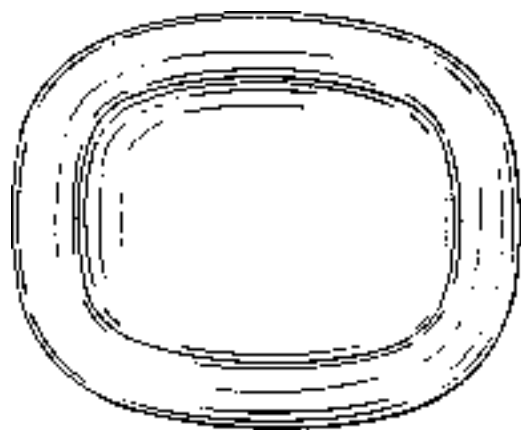
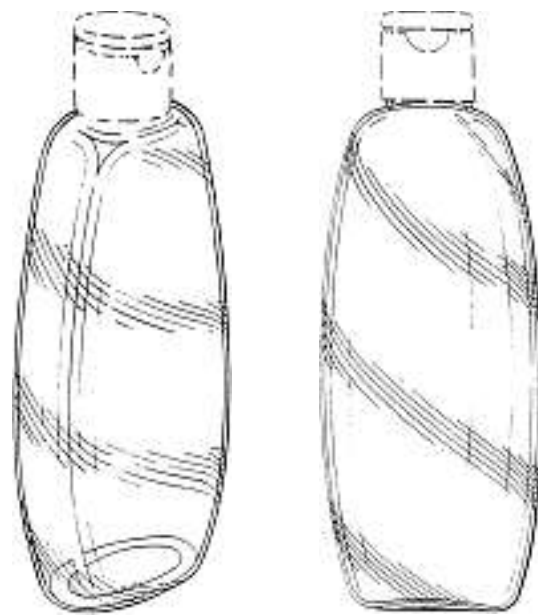

8

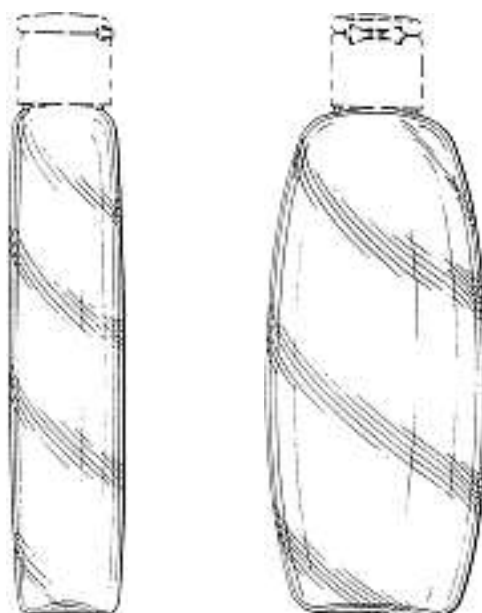

9

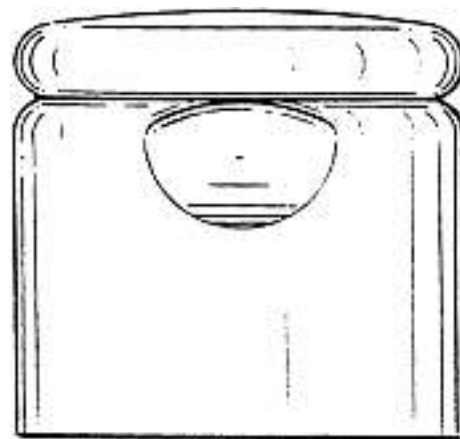
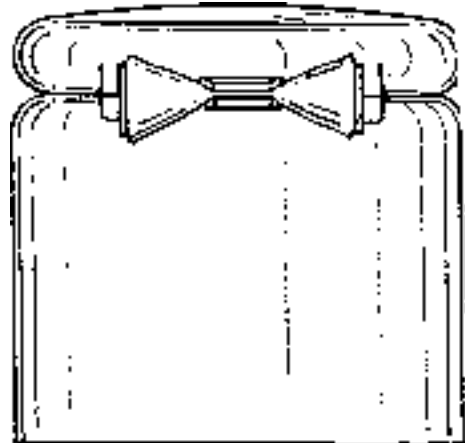
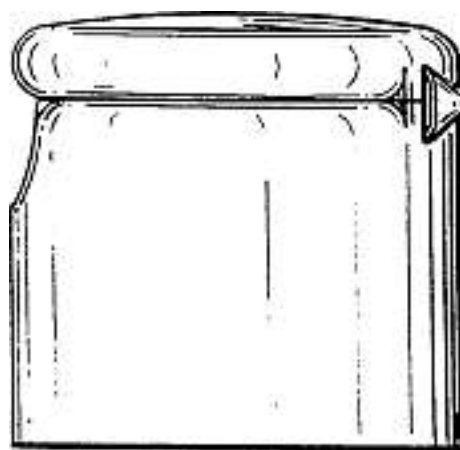
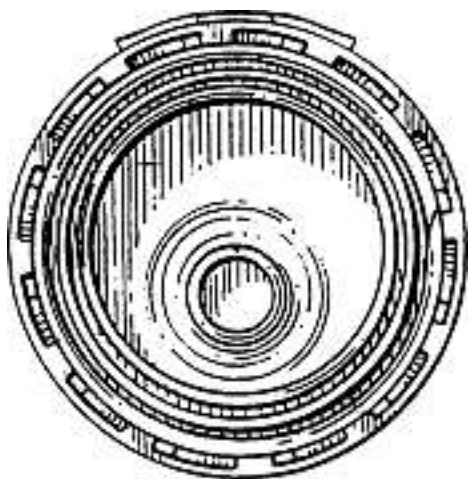
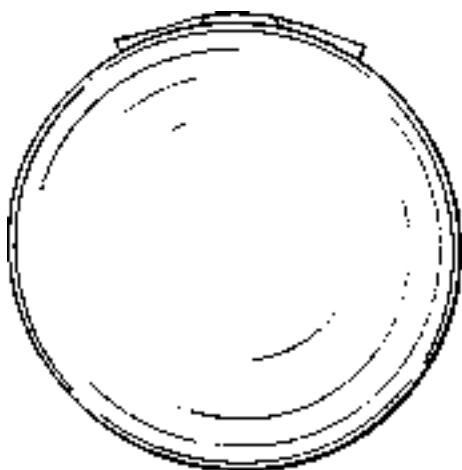

120 420 Cl. 14-99 1 Design

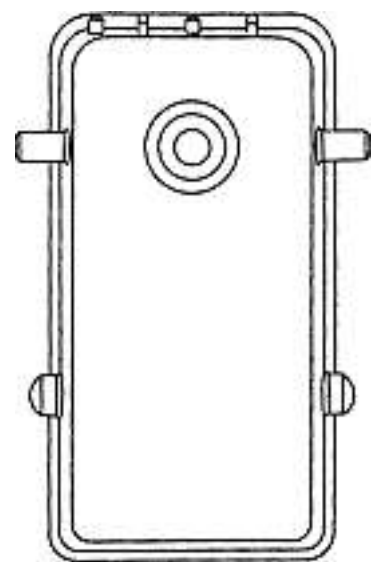
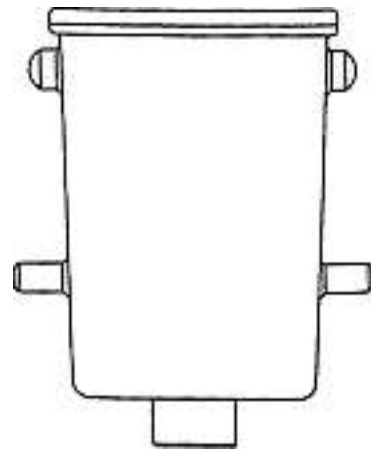
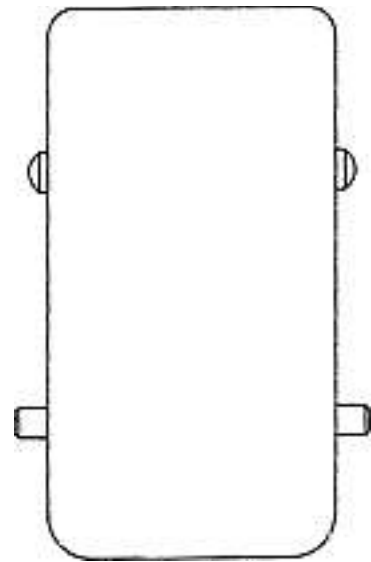
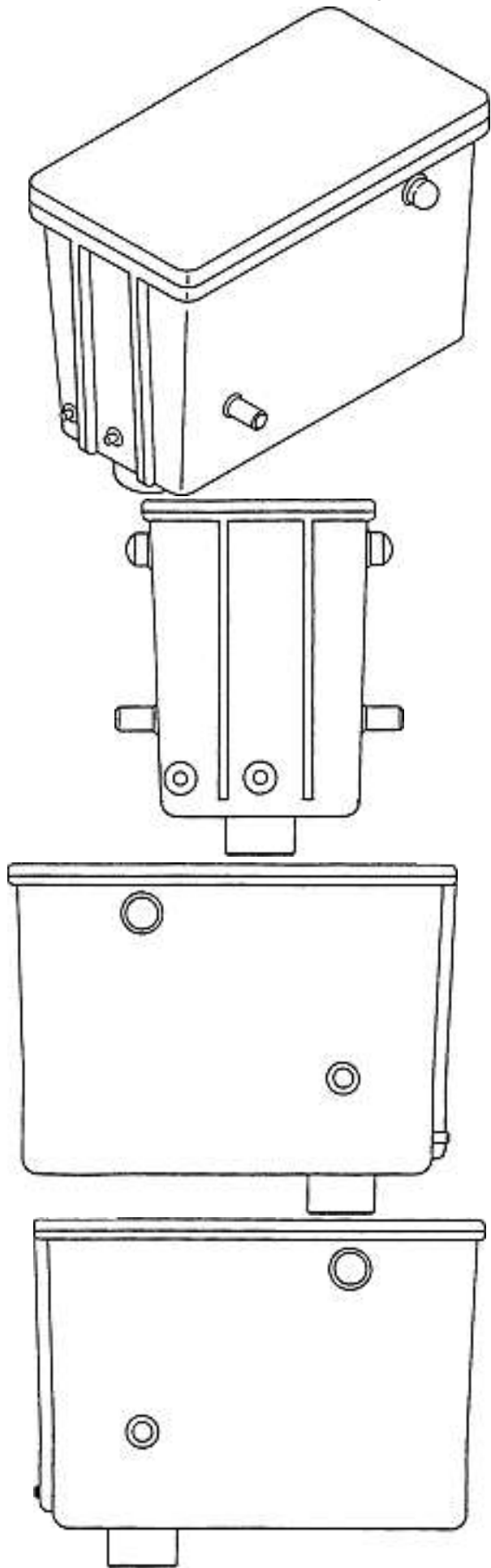

1.1-1.7

124 739	Cl.	07-04	2	Design
124 786	Cl.	08-06	3	Design
124 795	Cl.	20-03	89	Design
124 814	Cl.	07-05	2	Design
124 941	Cl.	21-01	1	Design
124 986	Cl.	13-03	15	Design
125 036	Cl.	23-01	1	Design
125 056	Cl.	06-01	2	Design
129 266	Cl.	14-01	1	Design
129 268	Cl.	14-03	1	Design
129 371	Cl.	16-04	1	design
129 388	Cl.	08-01	15	Design
129 422	Cl.	07-07	5	Design
129 438	Cl.	23-03	1	Design
129 485	Cl.	25-03	83	Design
129 505	Cl.	07-99	1	Design
129 543	Cl.	06-01	1	Design
129 549	Cl.	06-04	1	Design
129 576	Cl.	20-03	1	Design
129 604	Cl.	09-01	1	Design
129 643	Cl.	26-05	1	Design

Mutationen Modifications Modificazioni

123 436

Neuer Vertreter
Vertreter: Staiger, Schwald & Partner AG, 8027 Zürich

129 778

Vertreter Niederlegung

129 882

129 999

131 953

Namensänderung
Neuer Vertreter
Hinterleger: Oerlikon Heberlein Temco Wattwil AG,
Bleikenstrasse 11, 9630 Wattwil
Vertreter: Hepp Wenger Ryffel AG, 9500 Wil SG

130 626

130 722

Changement du nom
Déposant:
HUBLOT SA, Genève, rue de la Fontaine 7,
1204 Genève

131 524

131 704

131 708

131 709

Namensänderung
Hinterleger:
Knaack LLC, 420 East Terra Cotta Avenue,
Crystal Lake, IL 60014, US

**Löschungen
Radiations
Radiazioni**

116 086	Cl.	10-01	1 Design
119 789	Cl.	06-01	131 Design
119 814	Cl.	14-01	1 Design
119 819	Cl.	14-02	1 Design
119 912	Cl.	15-01	2 Design
124 272	Cl.	01-06	1 Design
124 282	Cl.	07-01	19 Design
124 284	Cl.	07-06	3 Design
124 285	Cl.	08-10	1 Design
124 291	Cl.	10-02	4 design
124 293	Cl.	10-07	1 Design
124 302	Cl.	19-06	4 design
128 915	Cl.	03-01	1 Design
128 917	Cl.	07-01	1 design
128 936	Cl.	06-03	1 Design
128 937	Cl.	06-04	2 Design
128 938	Cl.	06-06	1 design
128 945	Cl.	10-02	4 design
128 947	Cl.	11-01	2 Design
128 955	Cl.	19-08	1 Design
128 957	Cl.	21-04	2 design
128 958	Cl.	23-01	1 Design
128 960	Cl.	24-02	1 Design
128 962	Cl.	26-04	2 Design
128 969	Cl.	06-04	1 Design
129 025	Cl.	28-03	1 Design
129 026	Cl.	06-03	1 Design
129 076	Cl.	10-02	1 Design
129 100	Cl.	07-06	2 Design

Cl. 23-01

133 548

19.01.2007



1

Cl. 06-01, 06-03, 06-04

134 624

03.12.2007





2

1



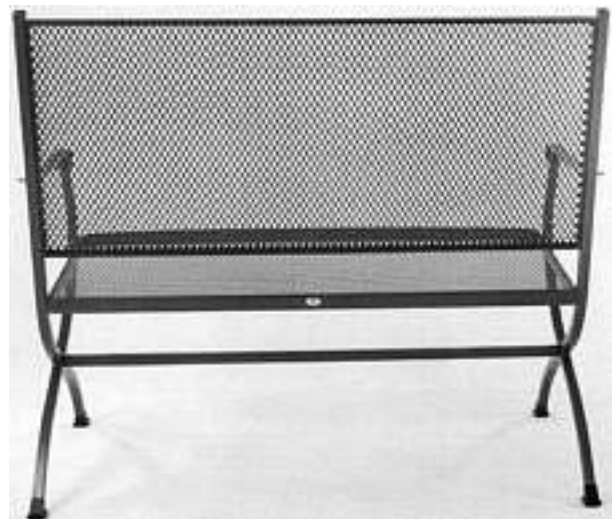
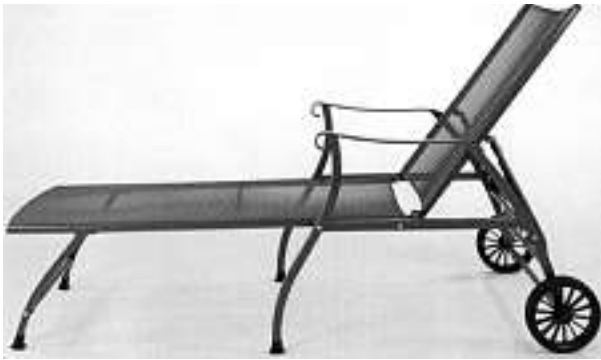



4



5



6





8



10



9





11



12



13

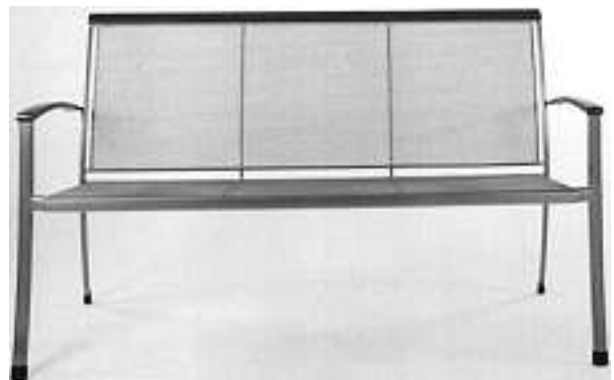

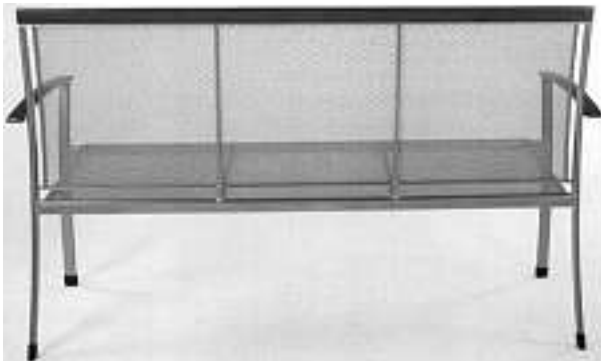





16



17





18

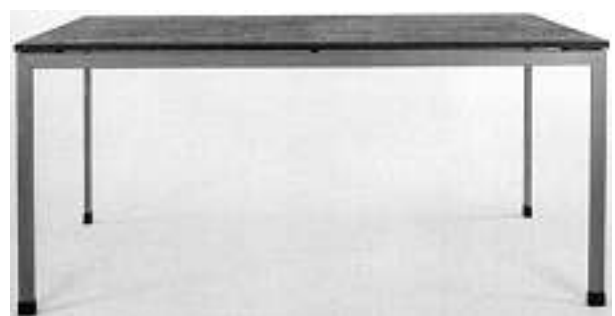

19



20

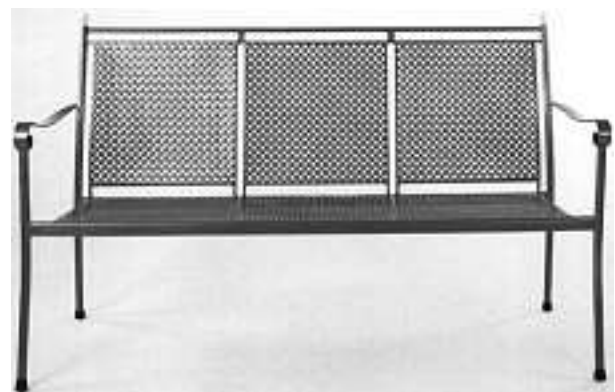

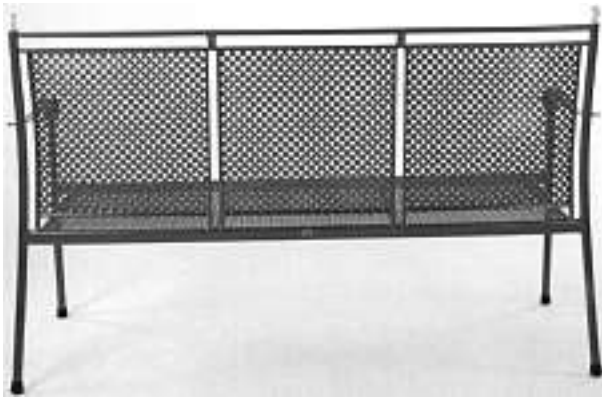
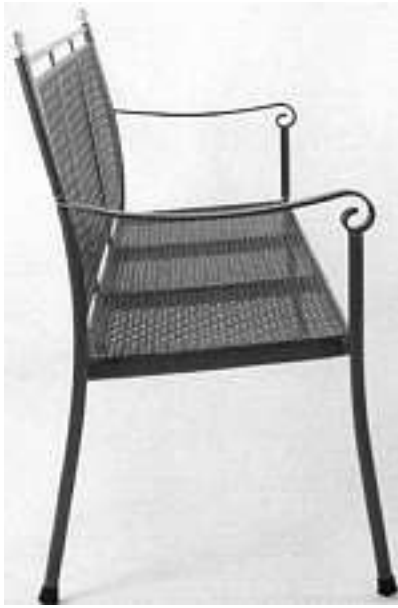

21



22



23





24



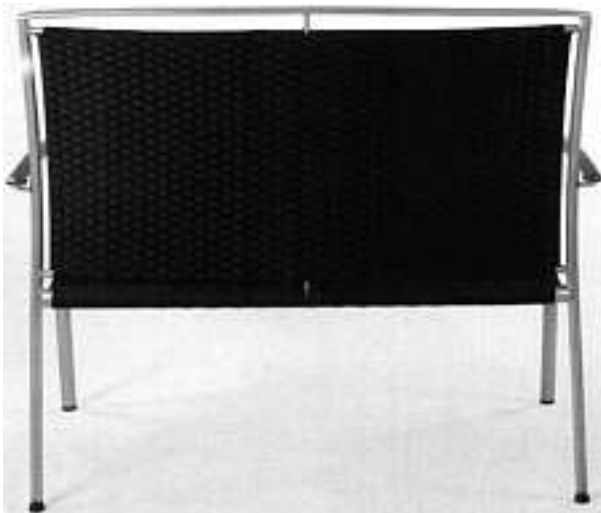



26



27





28



29







31



32



33

Cl. 07-99

134 637

03.12.2007

1



2



3



4



Cl. 08-08

134 641

29.11.2007

1

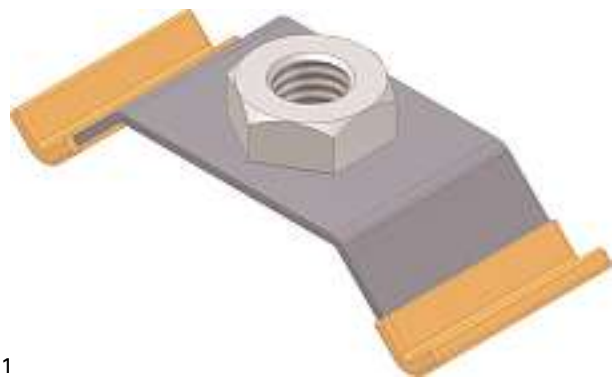

2

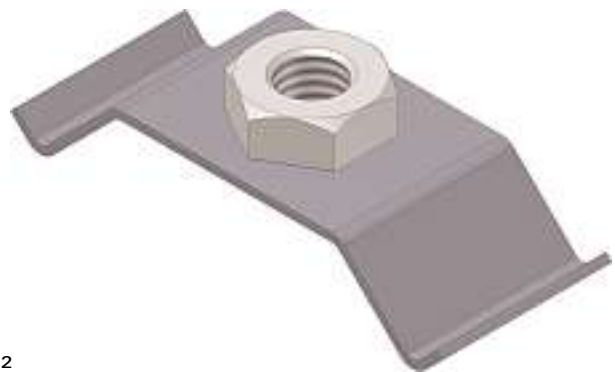

3

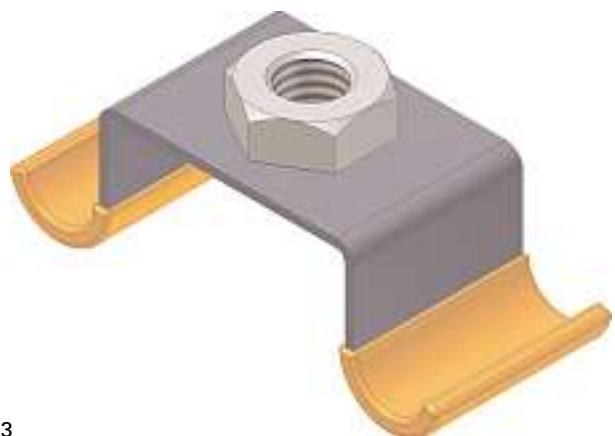

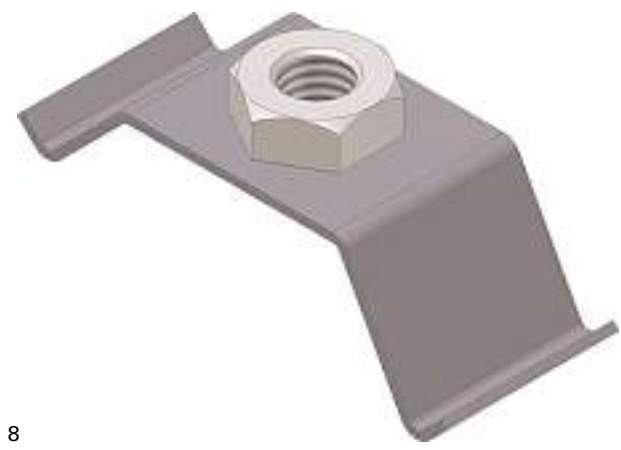

Cl. 15-07 134 652 18.12.2007

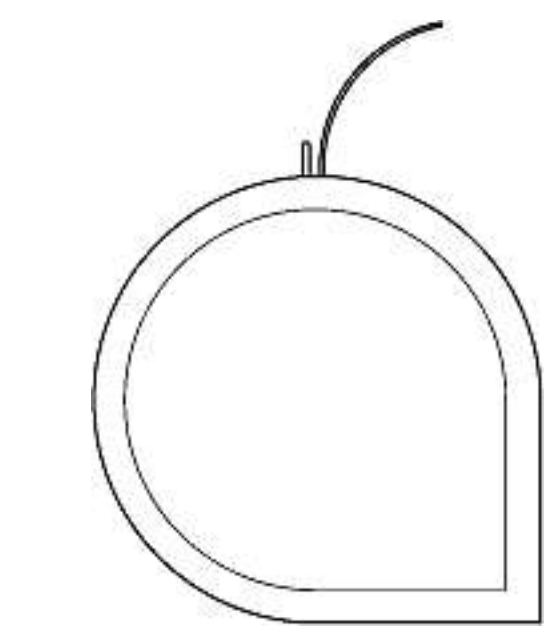
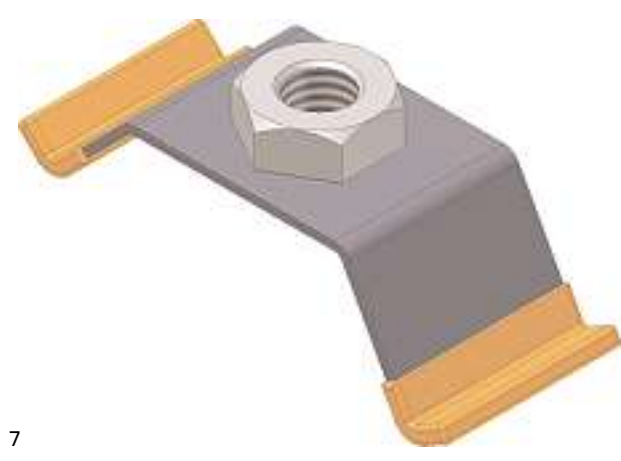
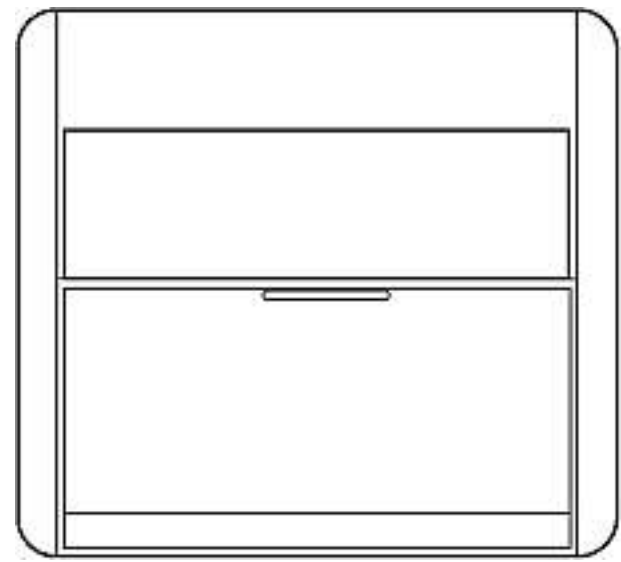
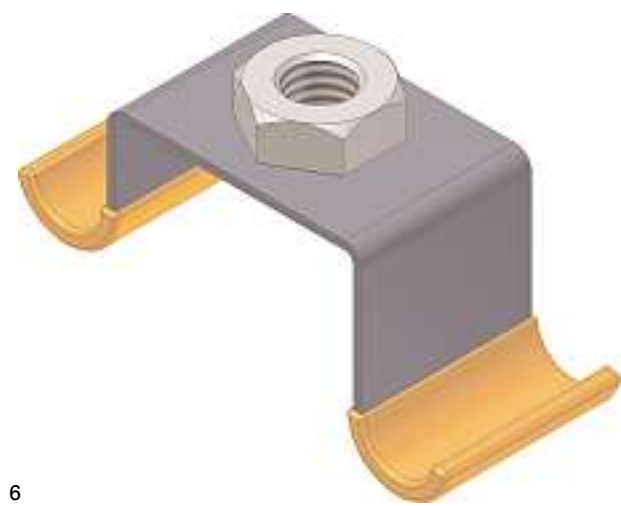

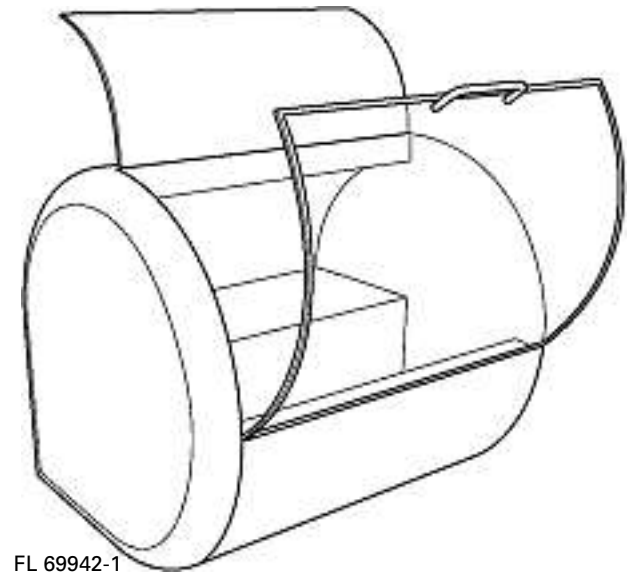
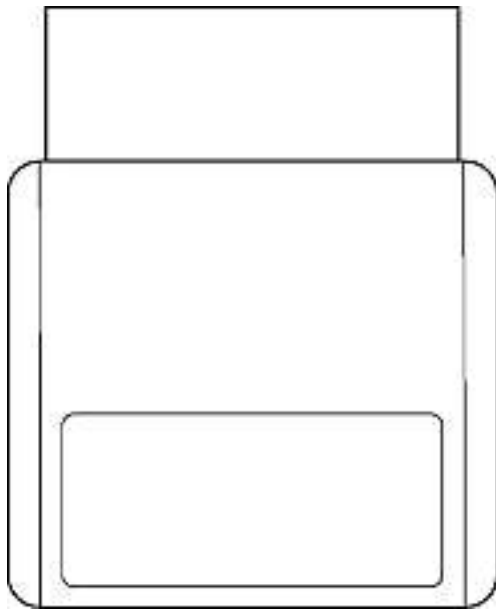
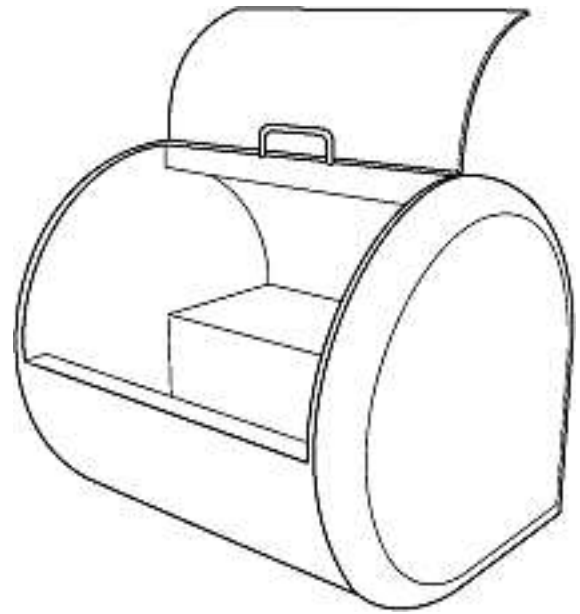
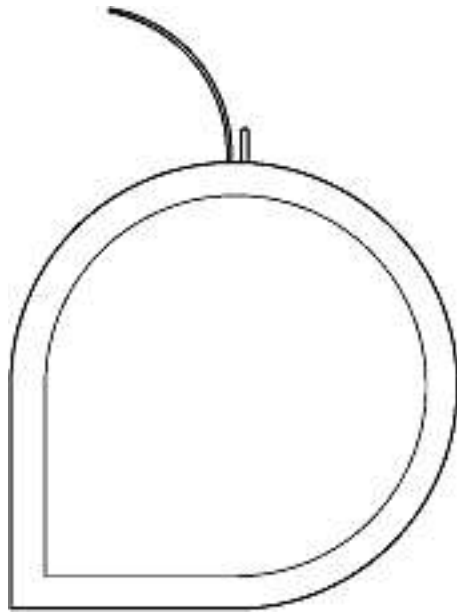

FL 69942-1

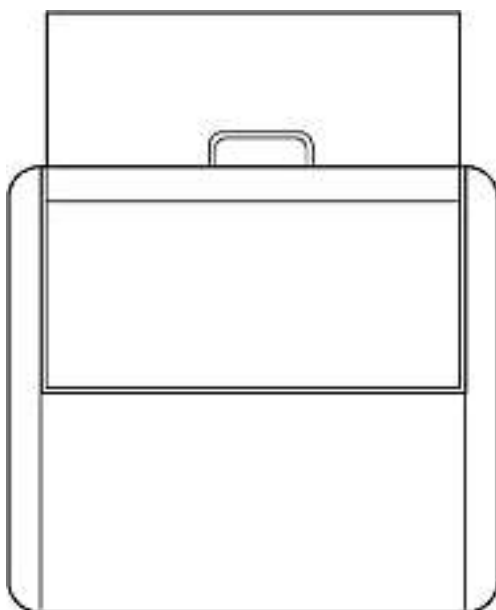



FL 69942-2

Cl. 15-09

134 653

11.12.2007

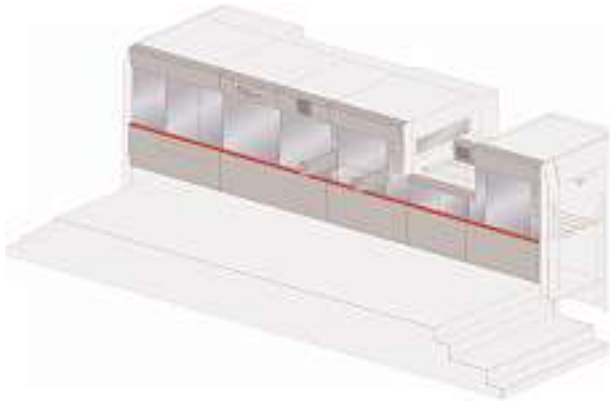

DMB02-01

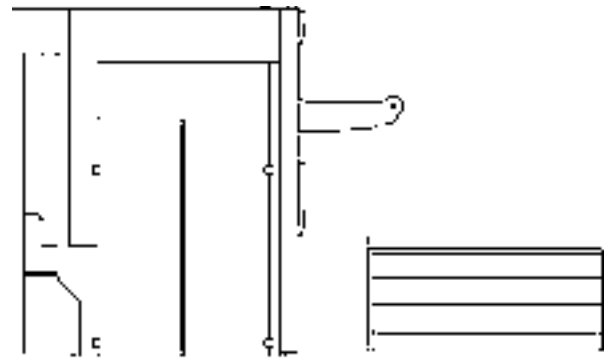
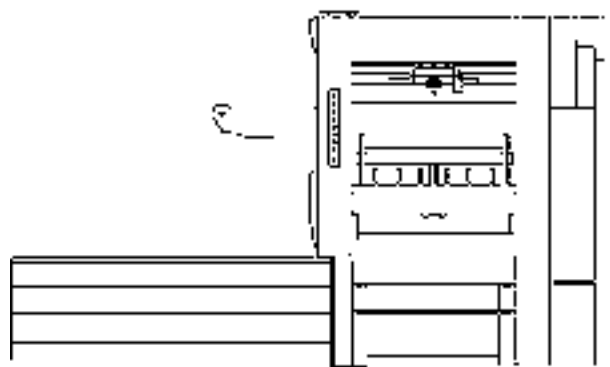
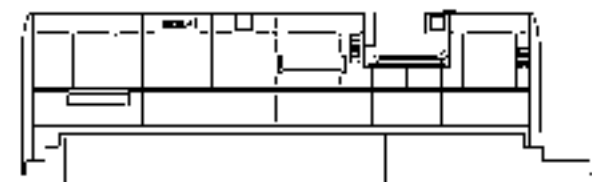
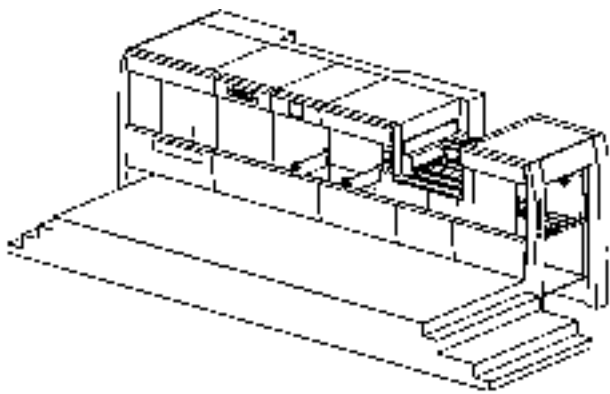

DMB02-02



DMB02-03

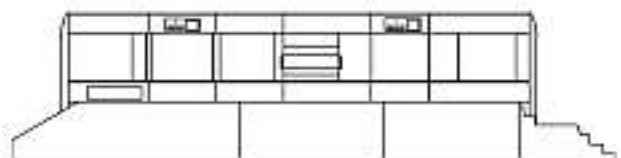
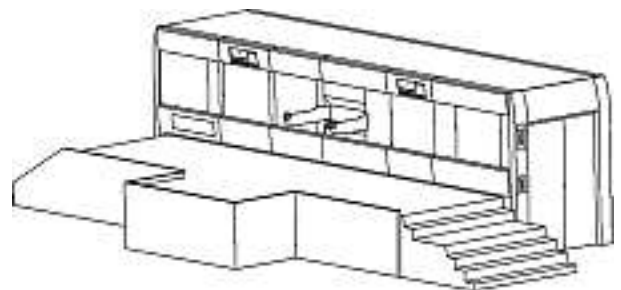

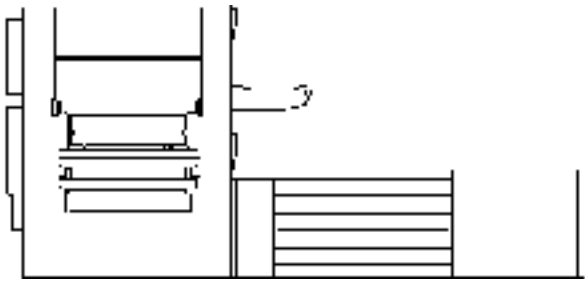
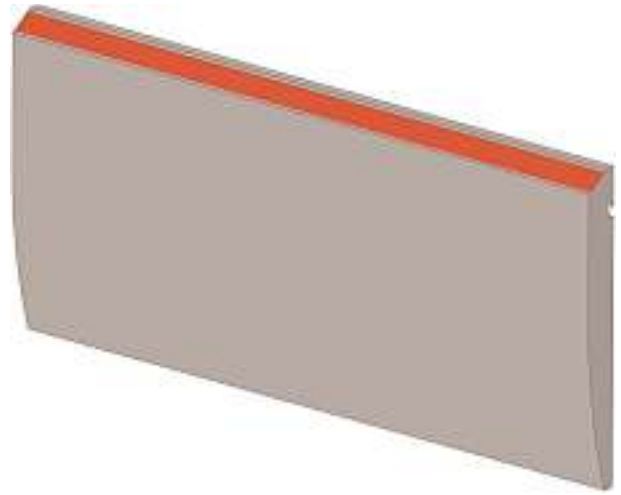
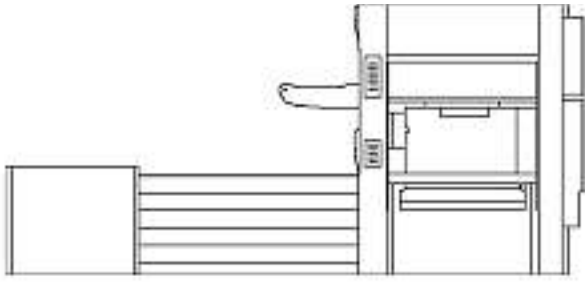

DMB02-04



DMB03-02

Cl. 15-09

134 654

11.12.2007

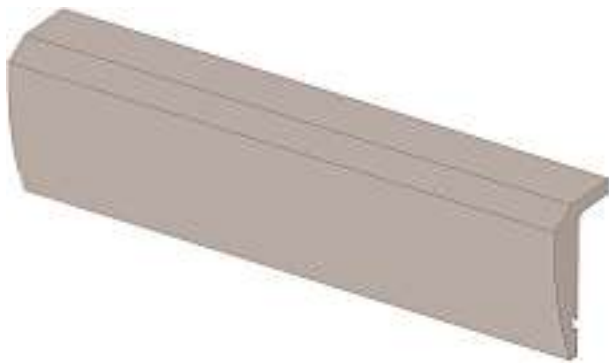

DMB03-01

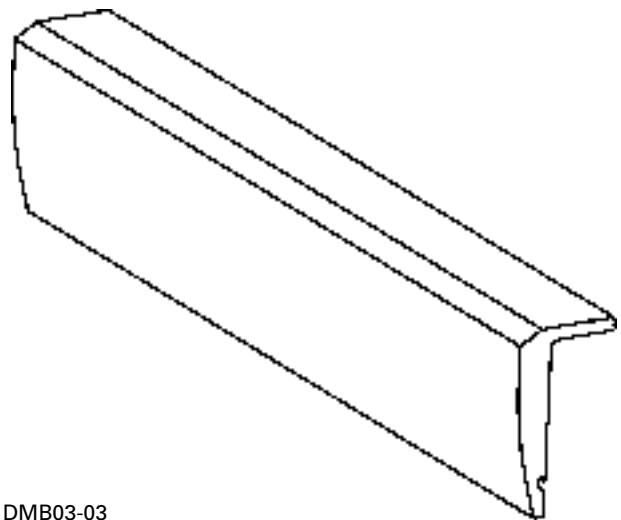

DMB03-03

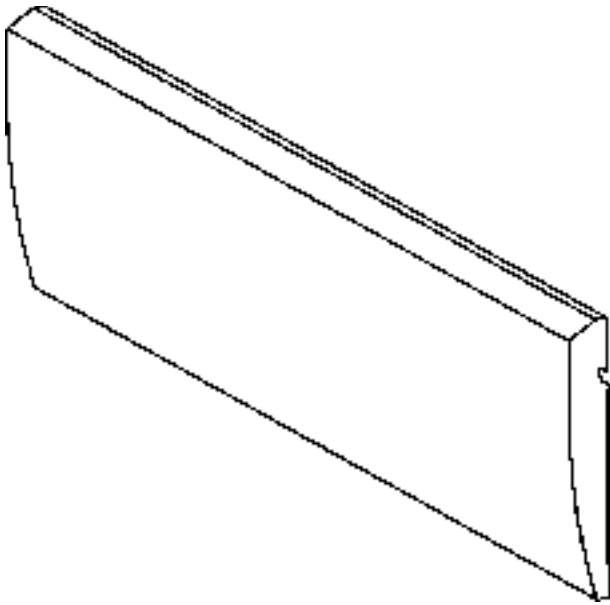

Cl. 23-04

134 664

22.11.2007



DMB03-04



DMB03-05





Cl. 26-05

134 666

20.12.2007





1

Cl. 26-05

134 667

20.12.2007



