

Nationale Hinterlegungen

In der folgenden Liste werden die beim Eidgenössischen Institut für Geistiges Eigentum hinterlegten Designs publiziert. Dabei sind der Reihe nach angegeben:

- internationale Klassenangaben
- Hinterlegungsnummer
- Hinterlegungsdatum
- Allenfalls Aufschub der Veröffentlichung
- Anzahl der hinterlegten Designs
- Bezeichnung
- Name und Wohnsitz des Hinterlegers oder der Hinterlegerin
- gegebenenfalls Name und Wohnsitz des Designers oder der Designerin
- Name und Geschäftssitz des allfälligen Vertreters oder der Vertreterin
- gegebenenfalls Prioritätsangaben
- gegebenenfalls Beschreibungstext
- Ordnungsnummer
- Reproduktion des Designs

Internationale Hinterlegungen

Die bei der Weltorganisation für geistiges Eigentum in Genf hinterlegten Muster und Modelle mit Benennung Schweiz geniessen den gleichen Schutz wie national hinterlegte Designs. Sie werden jeweils im Blatt «Bulletin des dessins et modèles internationaux» veröffentlicht. Dieses Publikationsorgan ist deshalb für eine vollständige Recherche unbedingt beizuziehen.

Topographien

Angaben über die vom Eidgenössischen Institut für Geistiges Eigentum eingetragenen Topographien von Halbleitererzeugnissen werden in folgender Anordnung aufgeführt:

- Eintragsnummer
- Anmeldedatum
- Bezeichnung
- Name und Wohnsitz des Anmelders oder der Anmelderin
- gegebenenfalls Name und Wohnsitz des Herstellers oder der Herstellerin
- Name und Geschäftssitz des oder der allfälligen Bevollmächtigten
- Datum und Ort einer allfälligen ersten geschäftlichen Verbreitung der Topographie

Dépôts nationaux

Les designs déposés à l'Institut Fédéral de la Propriété Intellectuelle sont publiés dans la liste qui suit. Les indications y relatives sont mentionnées dans cet ordre:

- indications des classes internationales
- numéro de dépôt
- date de dépôt
- le cas échéant, ajournement de la publication
- nombre des designs déposés
- désignation
- nom et domicile du/de la déposant/e
- le cas échéant, nom et domicile du/de la designer
- nom et domicile de l'éventuel/le mandataire
- le cas échéant, indication de priorité
- le cas échéant, description du design
- numéro attribué à chaque design
- reproduction du design

Dépôts internationaux

Les dessins et modèles déposés à l'Organisation Mondiale de la Propriété Intellectuelle à Genève qui désignent la Suisse jouissent de la même protection que les dépôts nationaux. Ils sont chaque fois publiés dans la feuille «Bulletin des dessins et modèles internationaux». Pour une recherche complète, il est indispensable de consulter ledit organe de publication.

Topographies

Les indications concernant les topographies des produits semi-conducteurs, enregistrées par l'Institut Fédéral de la Propriété Intellectuelle, sont énumérées dans l'ordre suivant:

- numéro d'enregistrement
- date de dépôt
- désignation
- nom et domicile du/de la déposant/e
- le cas échéant, nom et domicile du/de la producteur/trice
- nom et domicile de l'éventuel/le mandataire
- date et lieu d'une éventuelle première mise en circulation de la topographie

Depositi nazionali

Nella lista seguente vengono pubblicati i design depositati presso l'Istituto Federale della Proprietà Intellettuale. Sono menzionati nel seguente ordine:

- indicazioni delle classi internazionali
- numero di deposito
- data del deposito
- se del caso, indicazione che la pubblicazione è stata differita
- numero dei design depositati
- designazione
- nome e domicilio del depositante
- se del caso, nome e domicilio del designer
- nome e sede di un eventuale mandataro
- se del caso, indicazioni di priorità
- se del caso, descrizione del design
- numero d'ordine
- riproduzione del design

Depositi internazionali

I disegni e modelli depositati presso l'Organizzazione Mondiale della Proprietà Intellettuale a Ginevra con denominazione Svizzera godono della medesima protezione del deposito nazionale. Essi vengono pubblicati ogni volta nel foglio «Bulletin des dessins et modèles internationaux». Quest'organo di pubblicazione è da consultare se si vuole effettuare una ricerca completa.

Topografie

Le indicazioni concernenti le topografie di prodotti a semiconduttori depositati presso l'Istituto Federale della Proprietà Intellettuale sono menzionate nell'ordine seguente:

- numero di registrazione
- data del deposito
- designazione
- nome e domicilio del/la richiedente
- se del caso, nome e domicilio del/la produttore/trice
- nome e sede di un eventuale mandataro
- data e luogo di un'eventuale prima messa in circolazione della topografia

**Hinterlegungen
Dépôts
Deposit**

Cl. 07-02 **131 364** 16.02.2005
 1 design – machine à boissons
 Déposant: Société des Produits Nestlé SA, 1800 Vevey
 Designer: Antoine Cahen, Lausanne; Philippe Cahen, Lutry
 Mandataire: Nestec S.A., 1800 Vevey
 Fin de la période ajournement de la publication



FL 56957

Cl. 09-01 **131 417** 02.02.2005
 1 Design – Flasche
 Hinterleger: Fayrouz International AG, Zone Industrielle Le
 Planchy, 1628 Vuadens
 Designer: Andrew William Bowyer, London; Glenn Kiernan,
 London
 Vertreter: A.W. Metz & Co. AG, 8024 Zürich
 Ende aufgeschobene Publikation





52699-CH-9-DA

Cl. 10-07 **131 469** 25.02.2005
 1 design – bracelet de montre
 Déposant: Chaumet International S.A., 12, Place Vendôme,
 75001 Paris, FR
 Designer: Thierry Fritsch, Paris
 Mandataire: Griffes Consulting S.A., 1206 Genève
 Fin de la période ajournement de la publication

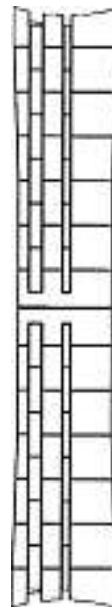
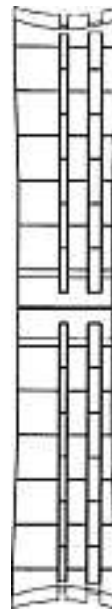
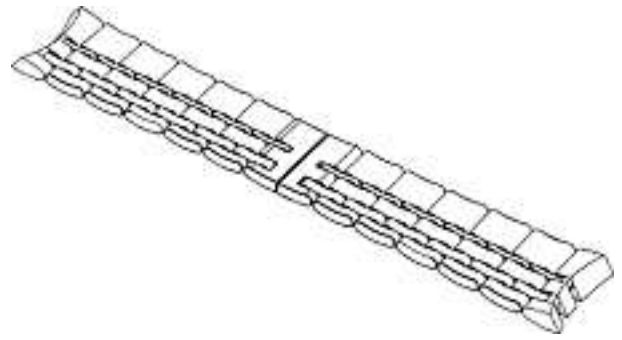

MO-69423-CH

Cl. 14-01 **131 663** 06.04.2005
 1 Design – Lautsprecher
 Hinterleger: Bang & Olufsen A/S, Peter Bangs Vej 15,
 7600 Struer, DK
 Designer: David Lewis, Copenhagen
 Vertreter: A.W. Metz & Co. AG, 8024 Zürich
 Priorität: DK, 22.12.2004
 Ende aufgeschobene Publikation

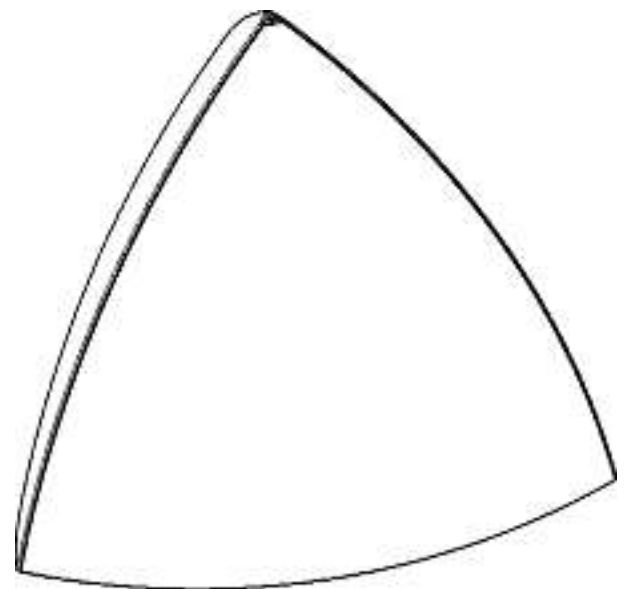
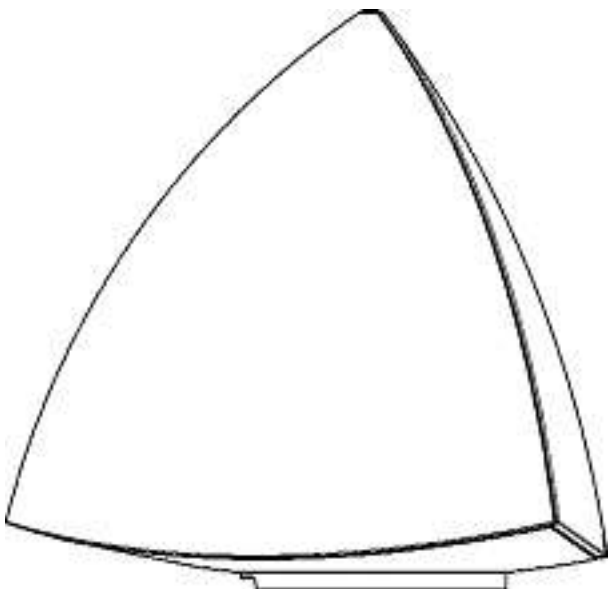
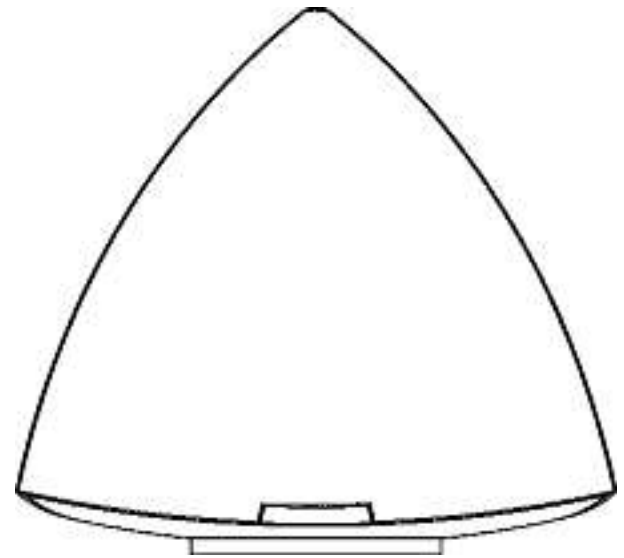
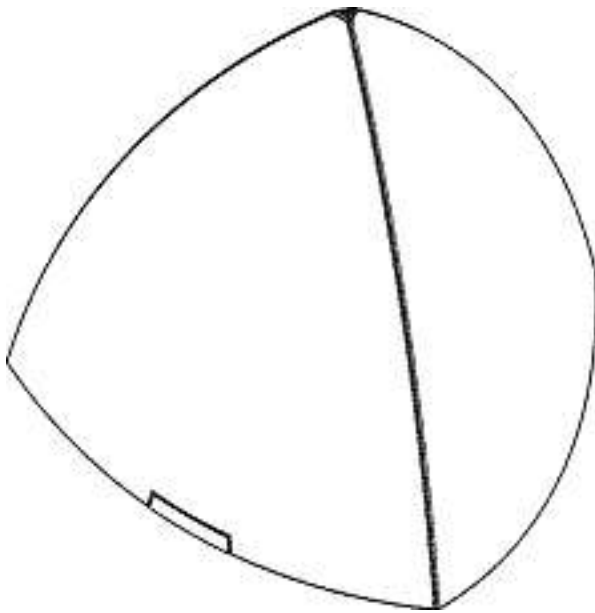
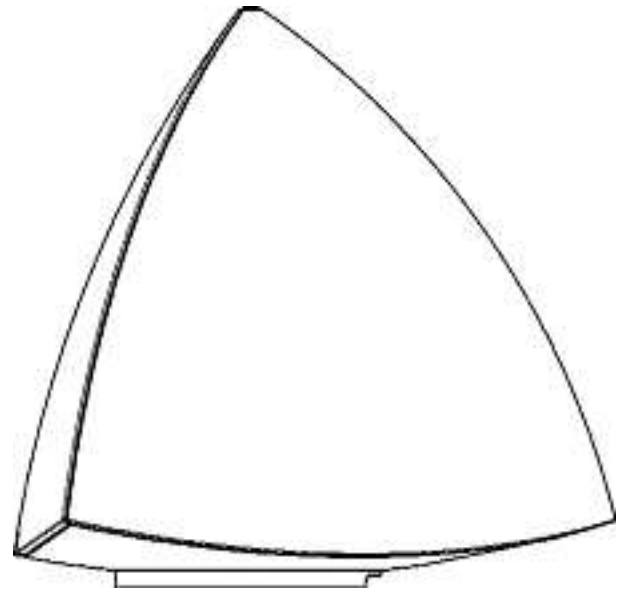
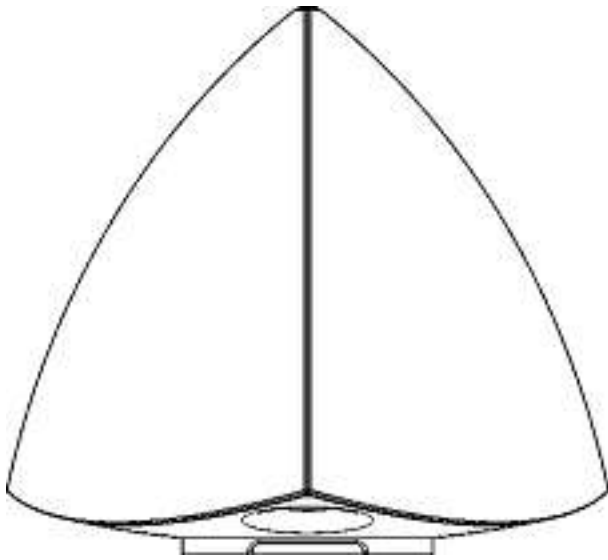

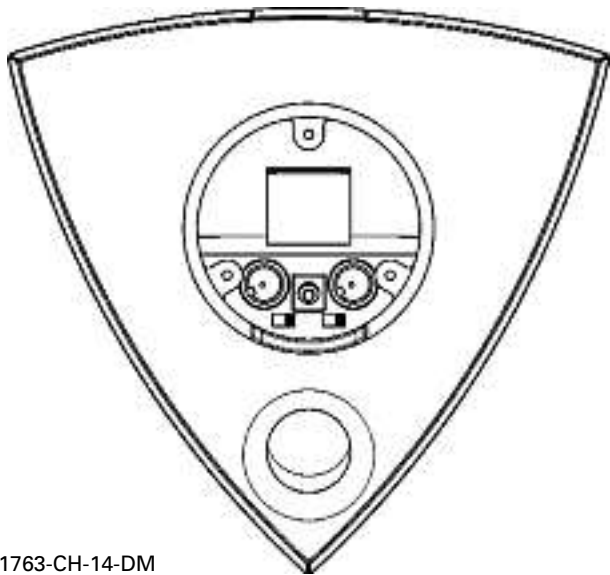
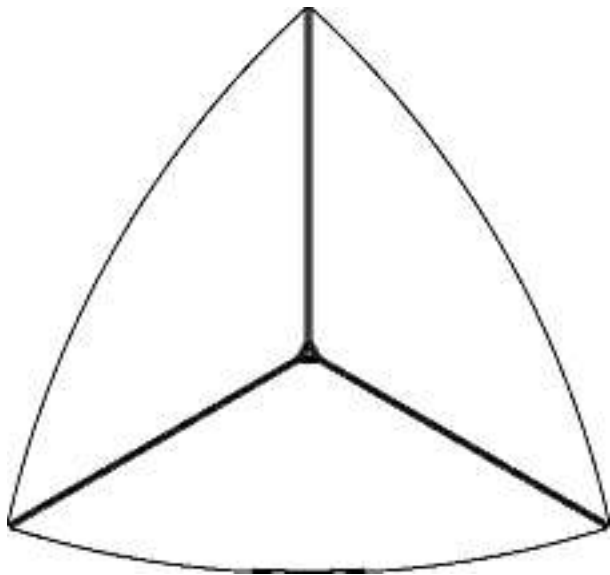

1763-CH-14-DM

Cl. 14-01 131 899 07.07.2005
 1 Design – Kopfhörer
 Hinterleger: Bang & Olufsen A/S, Peter Bangs Vej 15,
 7600 Struer, DK
 Designer: Anders Hermansen, Kopenhagen
 Vertreter: A.W. Metz & Co. AG, 8024 Zürich
 Priorität: DK, 05.04.2005
 Ende aufgeschobene Publikation

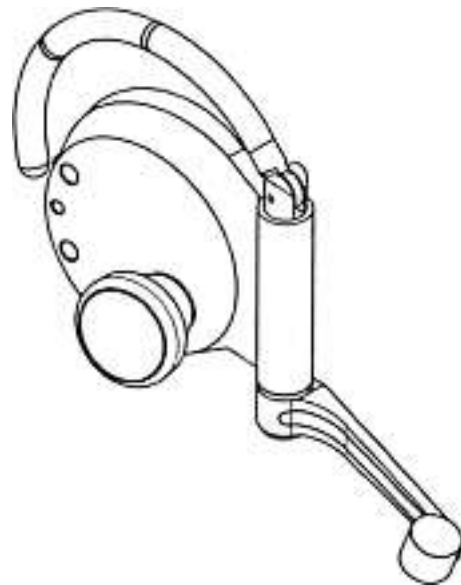
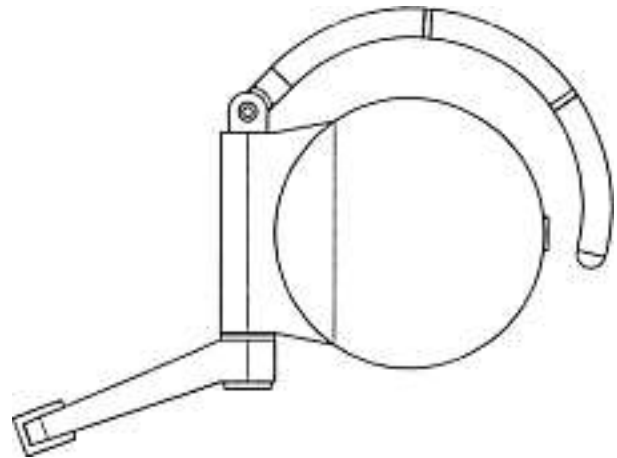
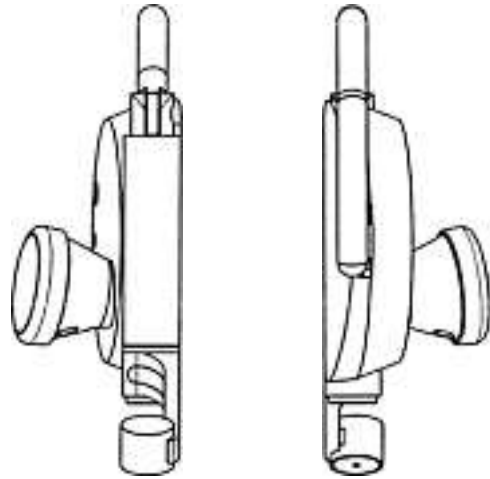
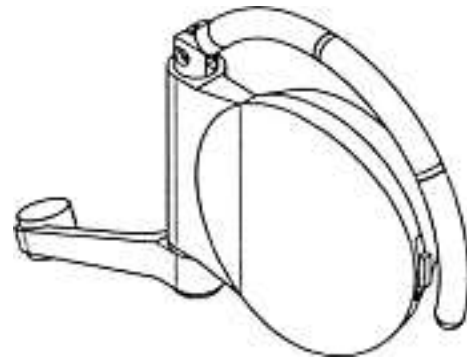
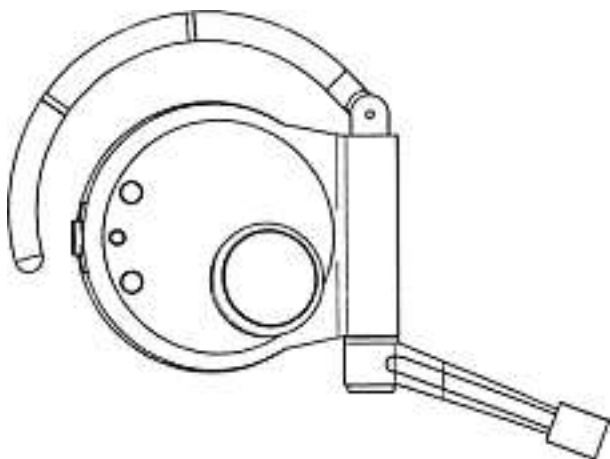

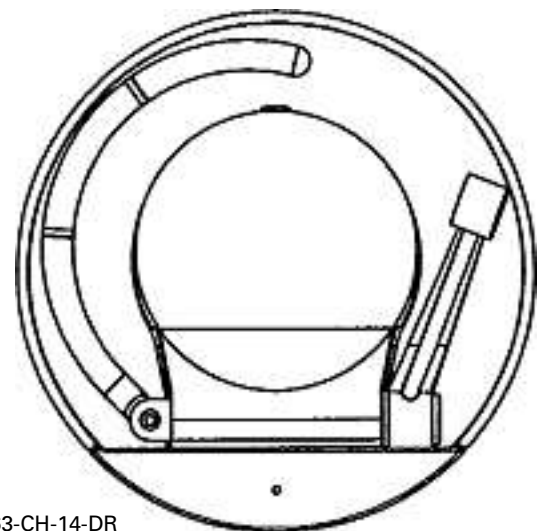
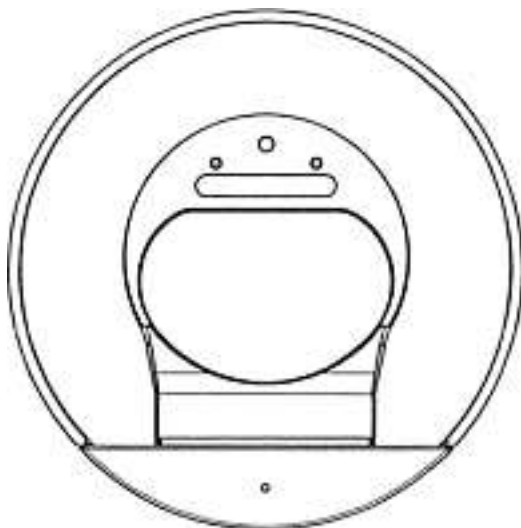
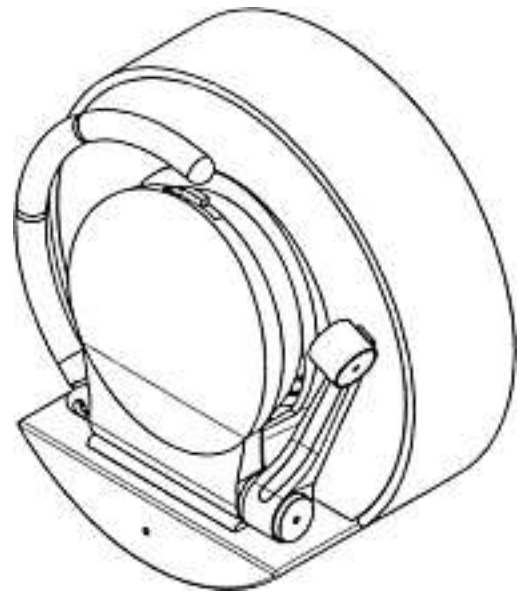
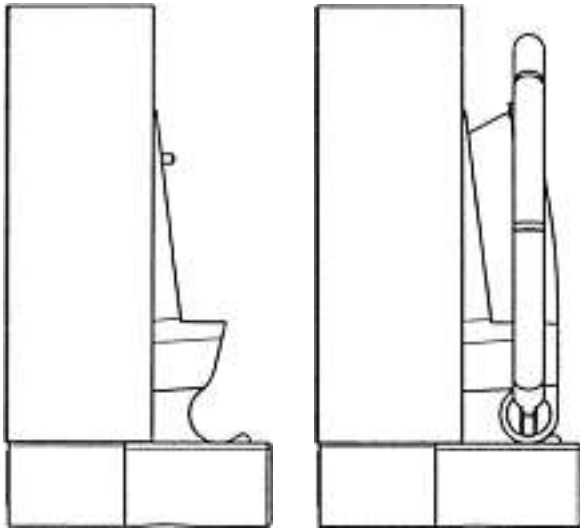
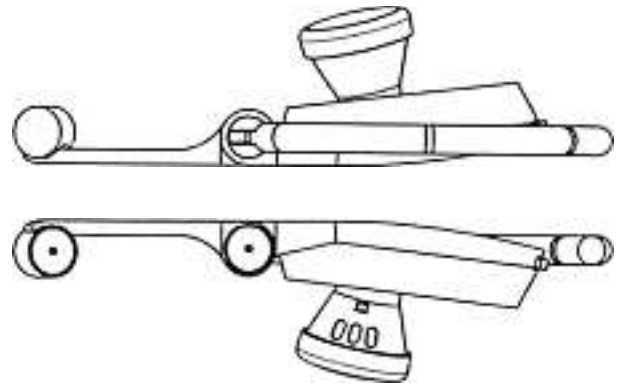
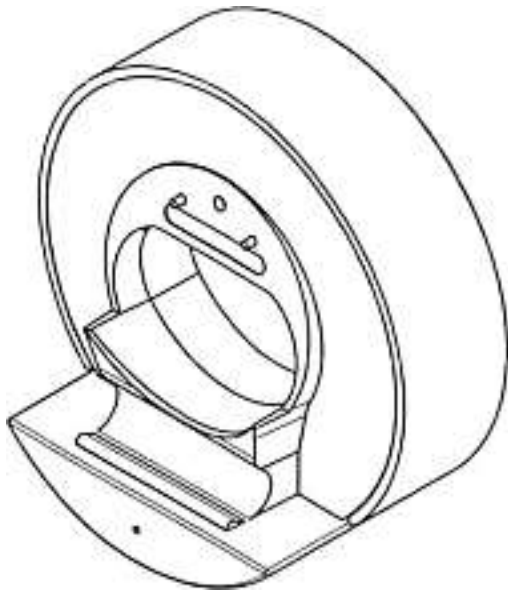

1763-CH-14-DR

Cl. 02-02 **134 100** 26.06.2007
 6 Design – Trainingsbekleidung
 Hinterleger: Keith R. Kernspecht, Schloss Langenzell,
 69257 Wiesenbach, DE
 Vertreter: Schneider Feldmann AG, Patent- und
 Markenanwälte, 8022 Zürich
 Priorität: EM, 01.02.2007

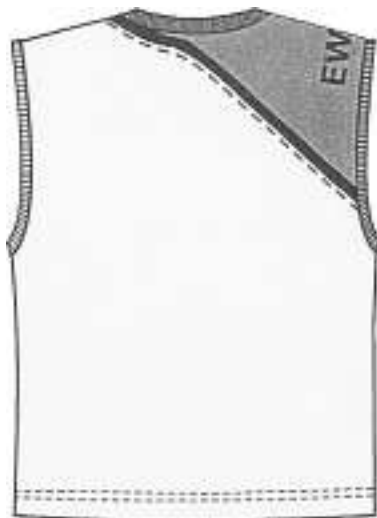
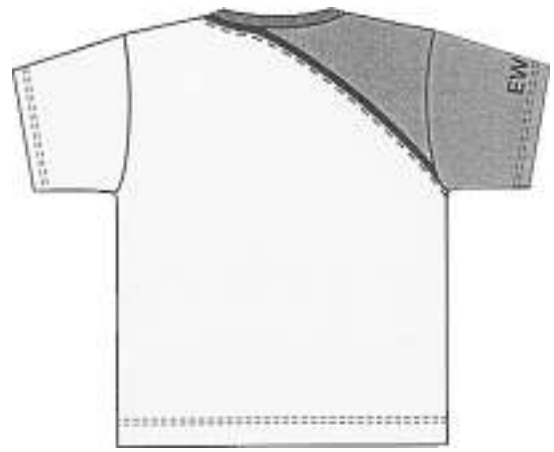

3

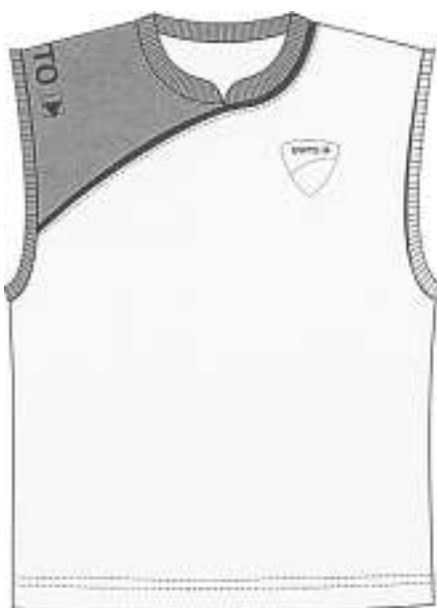

4

2





5



6

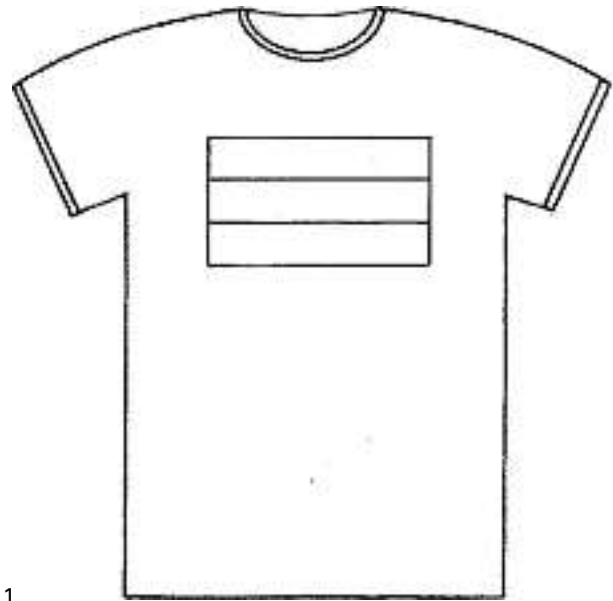

1

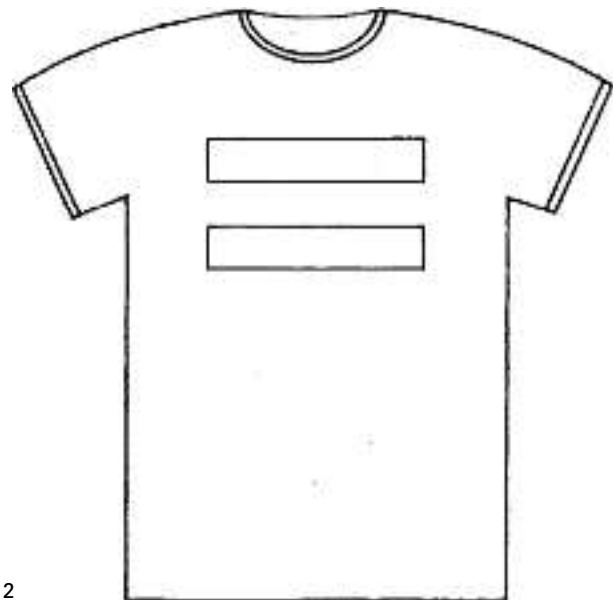

2

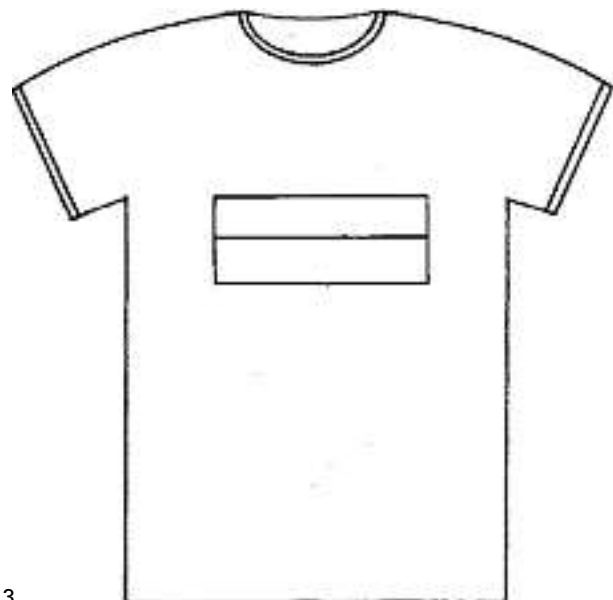

3

Cl. 02-02 134 101 04.07.2007

17 Design – Bekleidung

Hinterleger: Helmut Geringer, Raffaelstrasse 5,
85579 Neubiberg, DE

Vertreter: Ammann Patentanwälte AG Bern, 3001 Bern

Priorität: DE, 09.02.2007

Beschreibung des Designs: Jede Art von Bekleidung, auf welcher im Brust- oder Rückenbereich verschiedenste Motive sowie Flaggen und/oder geometrische Muster in verschiedensten Farbkombinationen ausgeführt werden, welche mit durchscheinendem als auch transparentem oder gitterähnlichem Materialmix kombiniert werden.

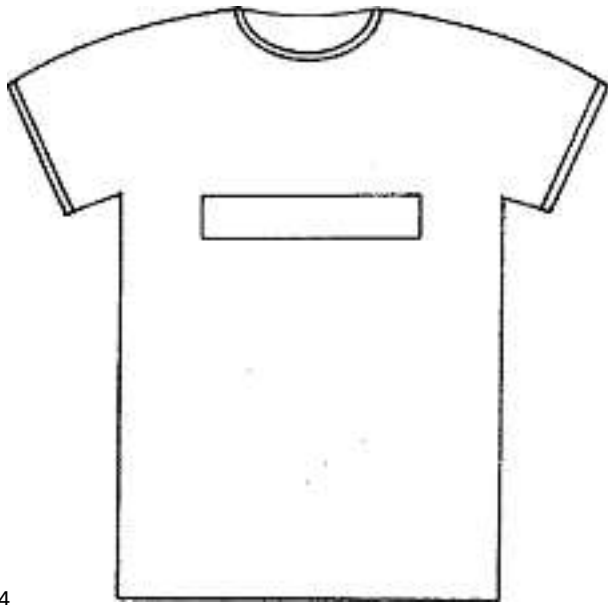

4

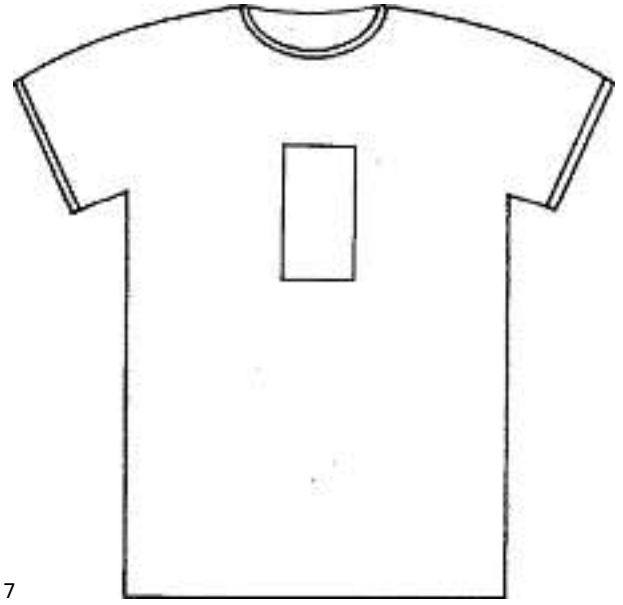

7

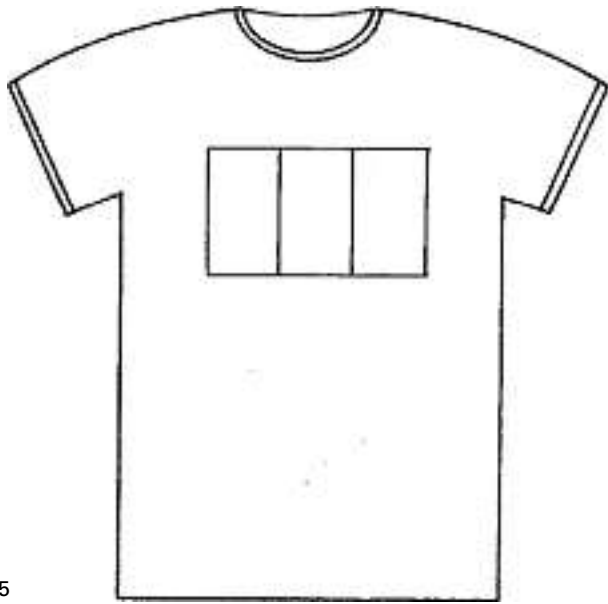

5

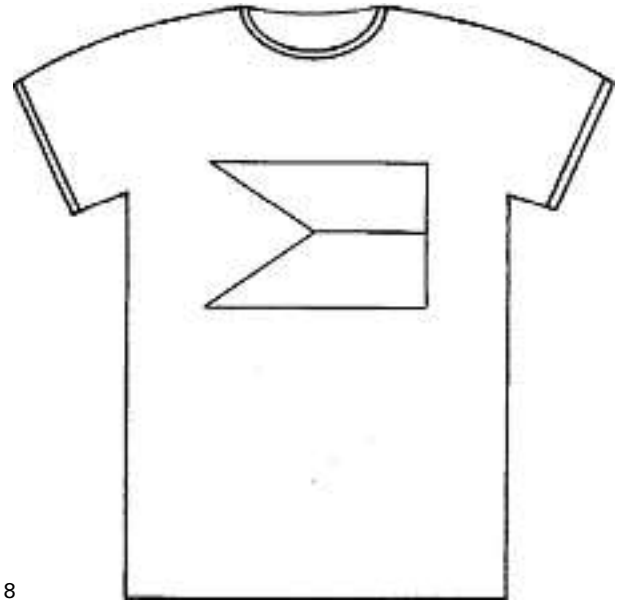

8

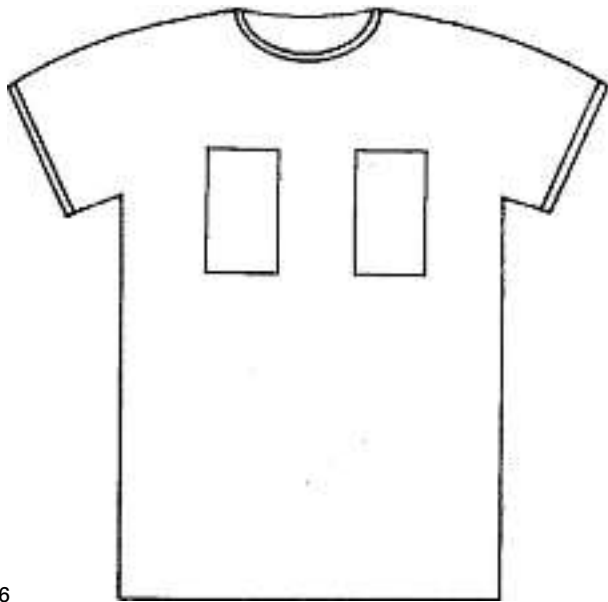

6

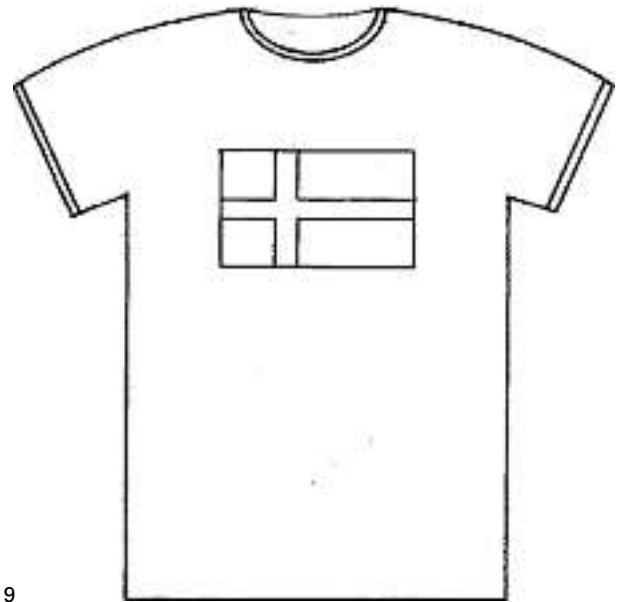

9

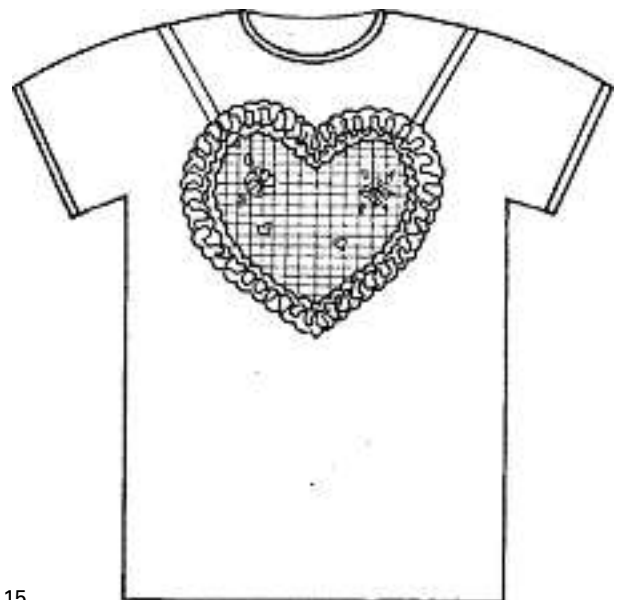
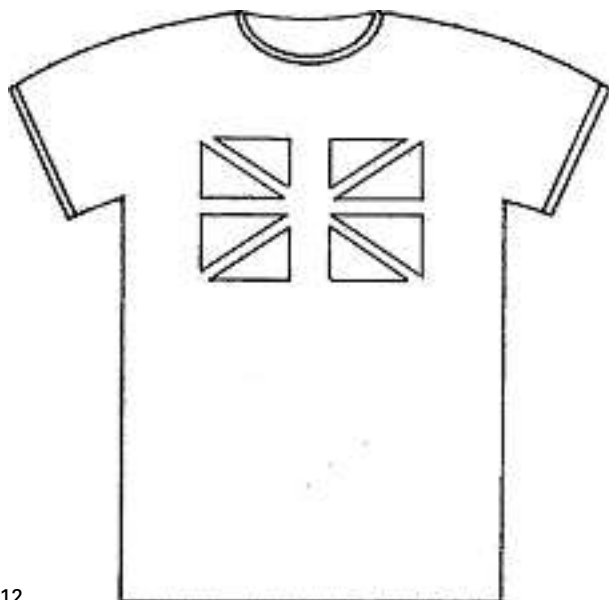
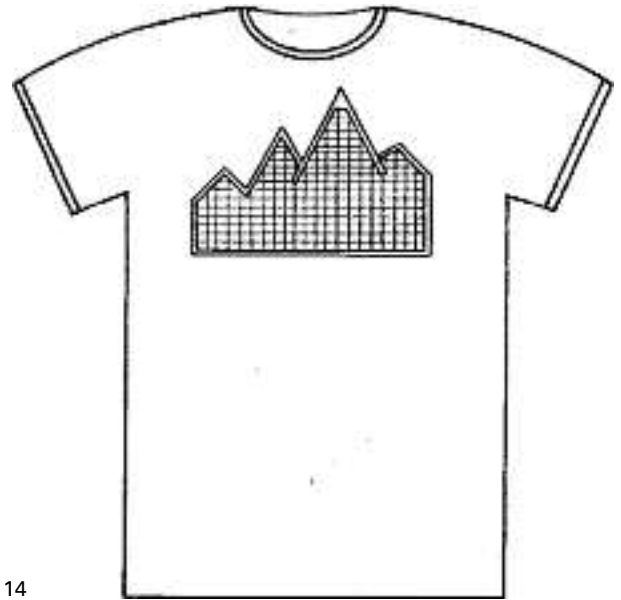
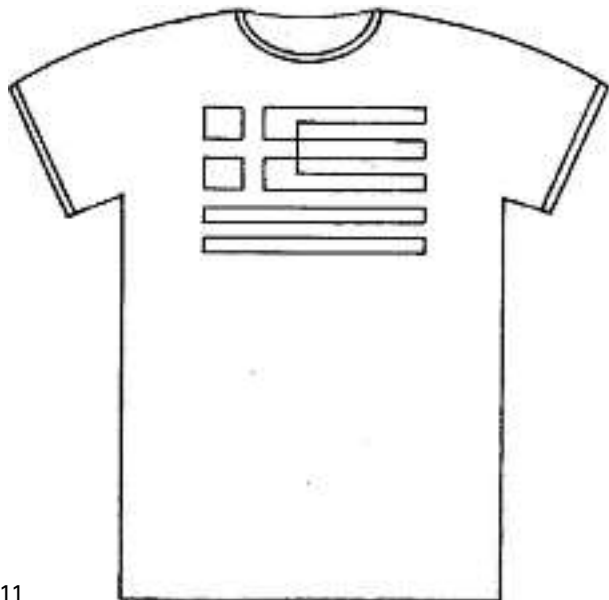
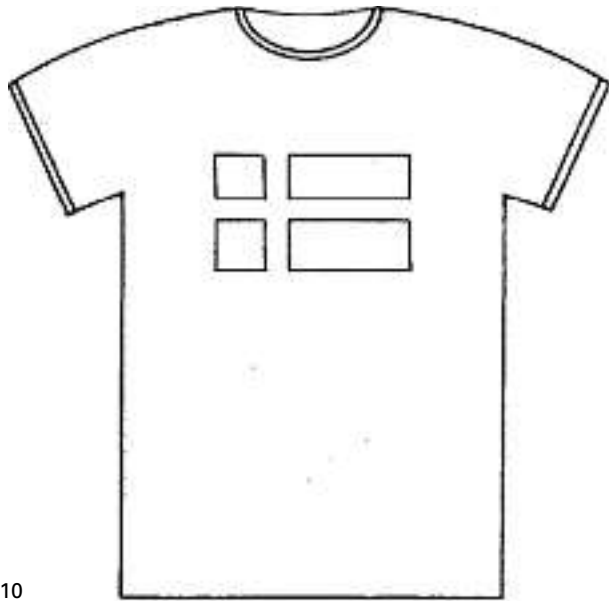

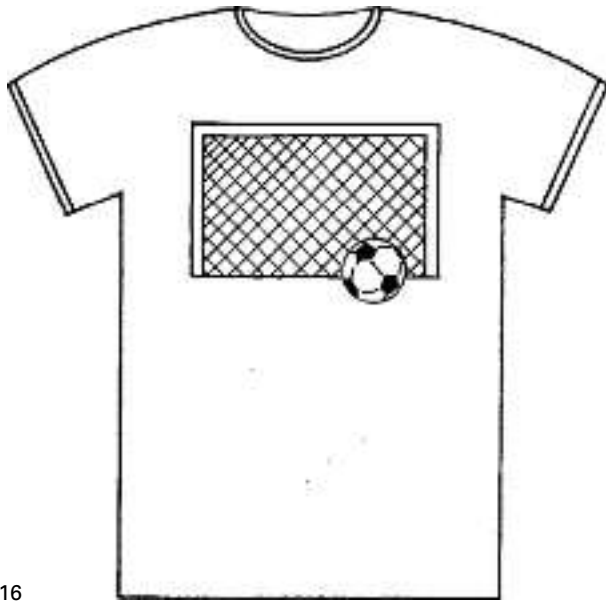

16



17

Cl. 02-04 **134 102** 26.06.2007
 3 Design – Schuhe
 Hinterleger: Christoph Kronwitter, Via Nagra 18,
 6926 Montagnola
 Vertreter: Fuhrer Marbach & Partner, 3007 Bern
 Priorität: EM, 21.06.2007



A



B

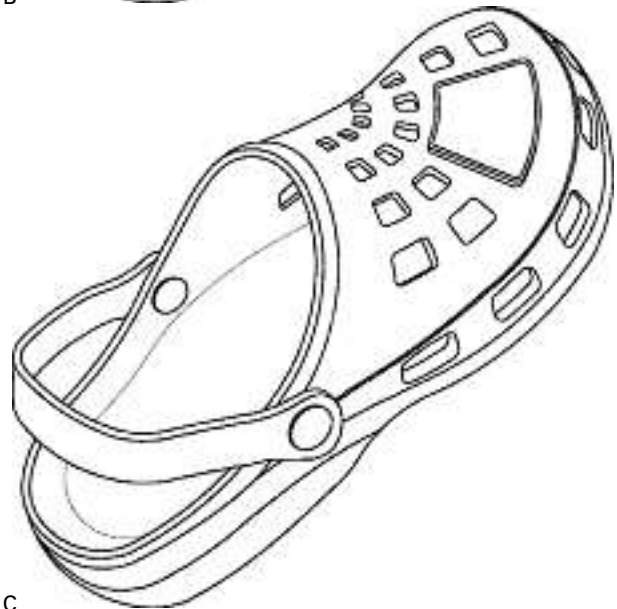

C

Cl. 06-01, 06-02, **134 105** 28.06.2007
 06-03, 06-04
 25 design – tavolini, letti, scaffali, sedie, poltrone, divani
 Depositante: Bonaldo SpA, Via Straelle 3, Villanova di
 Camposampiero (Padova), IT
 Designer: Mario Mazzer, Conegliano; Gino Carollo, Thiene;
 Giuseppe Viganò, Lissone; Mauro Lipparini, Firenze; Claudio
 Dondoli, Colle Val d'Elsa; James Bronte, Villanova di
 Camposampiero; Karim Rashid, New York; Stefan Heiliger,
 Frankfurt; Thomas Glenn, Villanova di Camposanpiero
 Mandatario: Jacobacci & Partners S.A., 1207 Genève



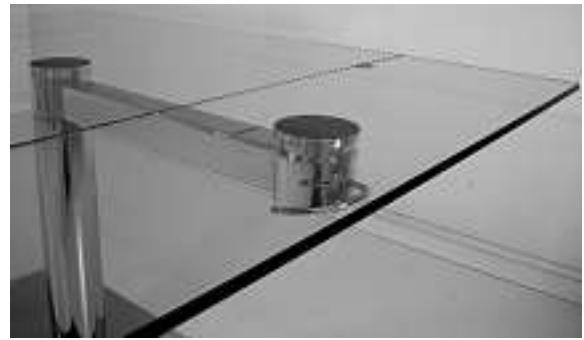
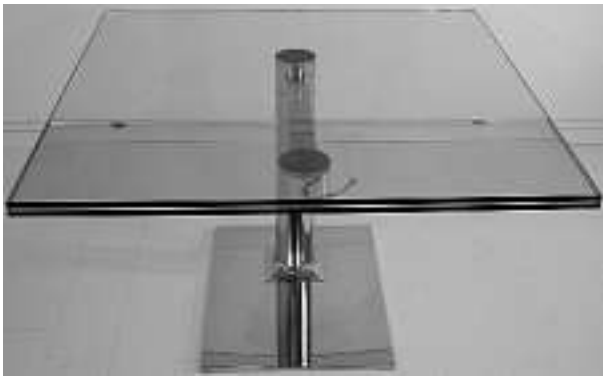

D-2080/07-S2

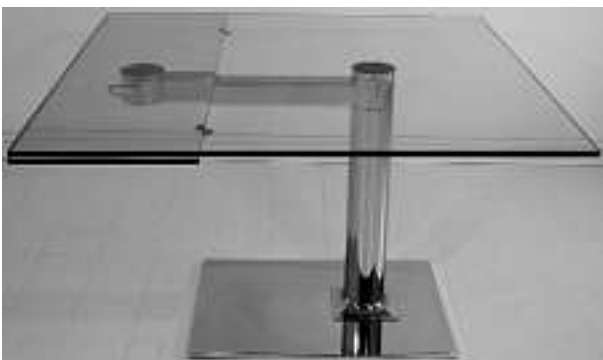

D-2080/07-S01

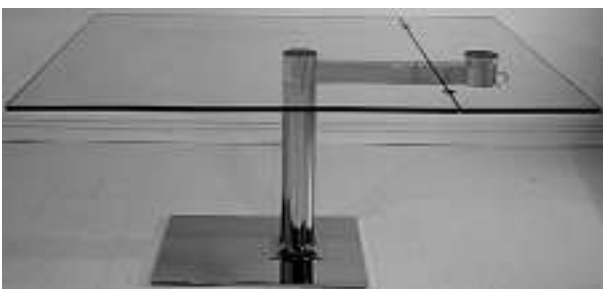



D-2080/07-S3

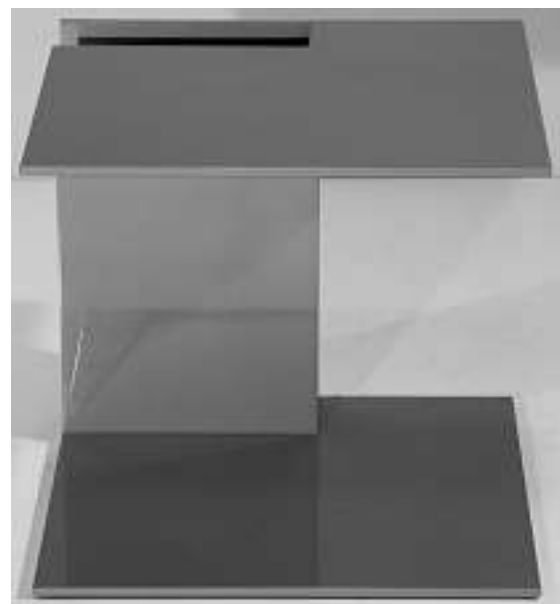
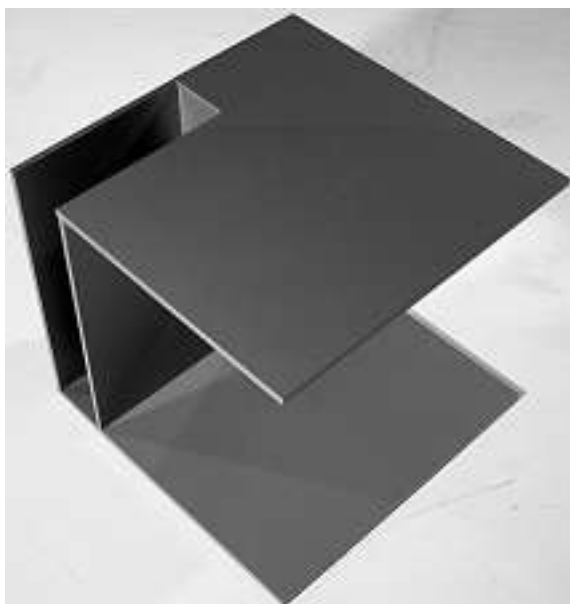

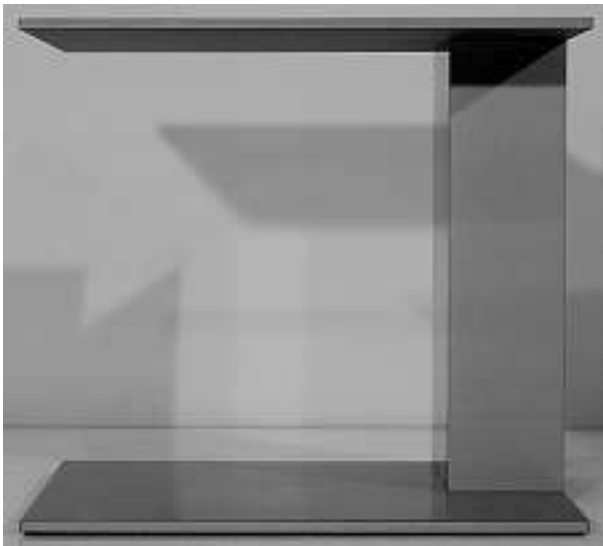

D-2080/07-S4

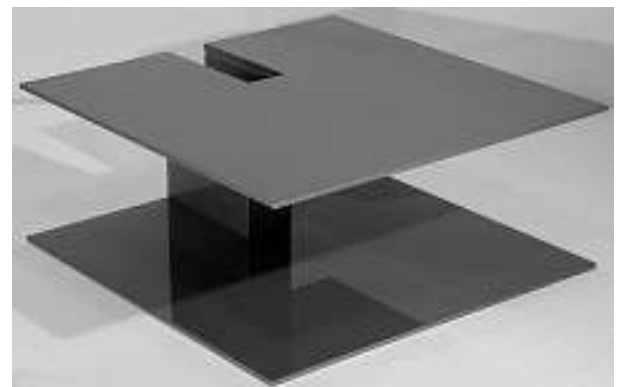
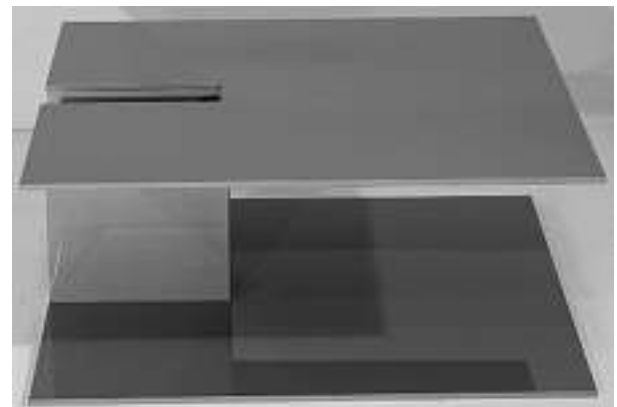
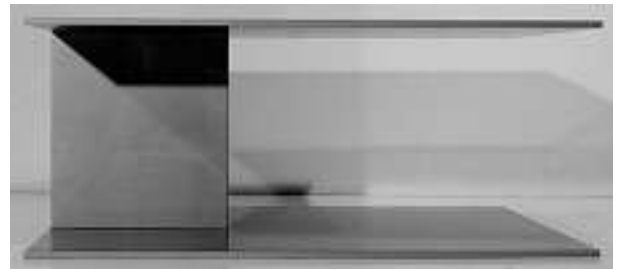

D-2080/07-S5

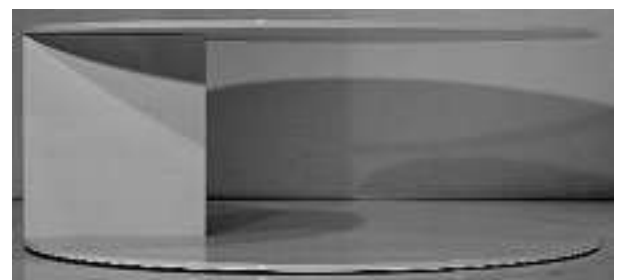

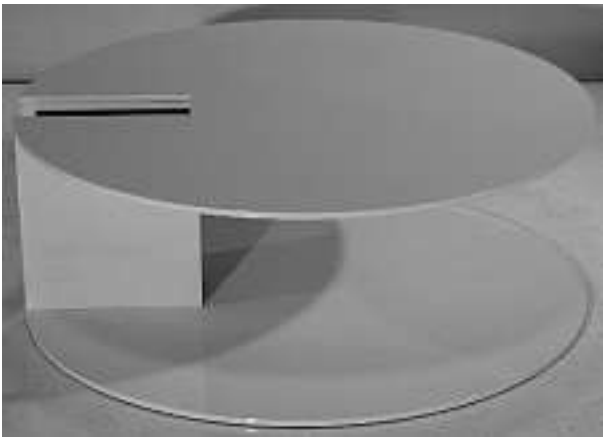
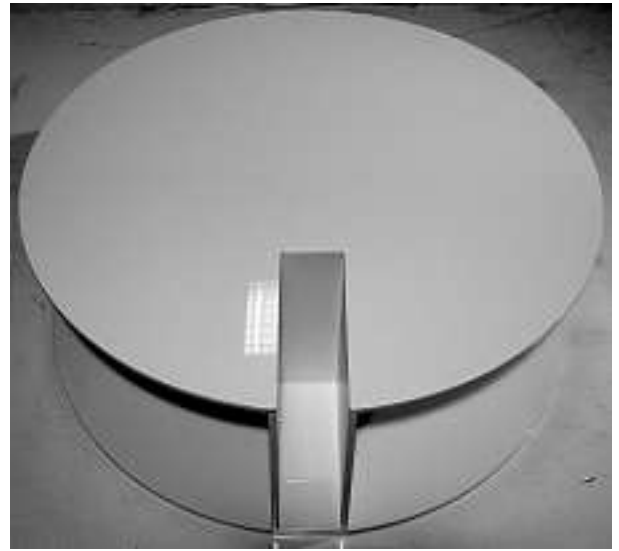
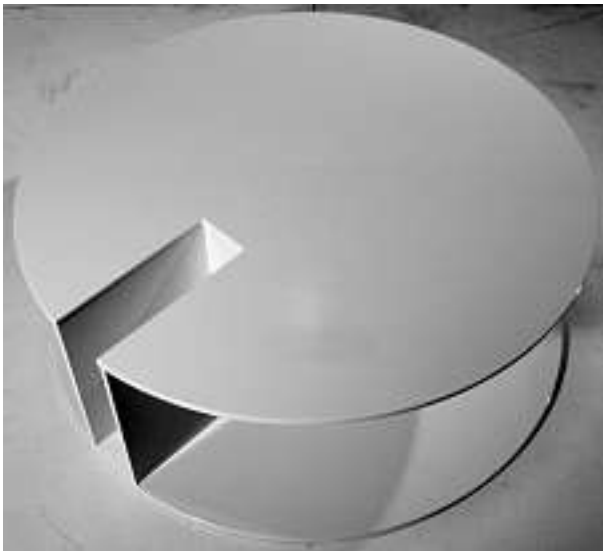

D-2080/07-S6

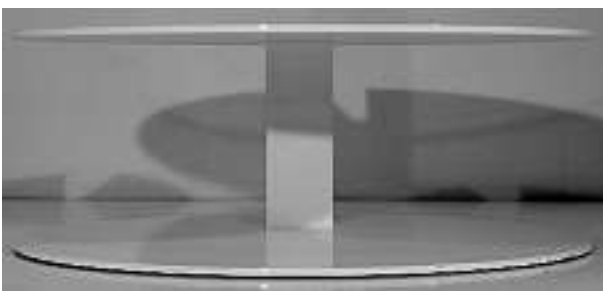
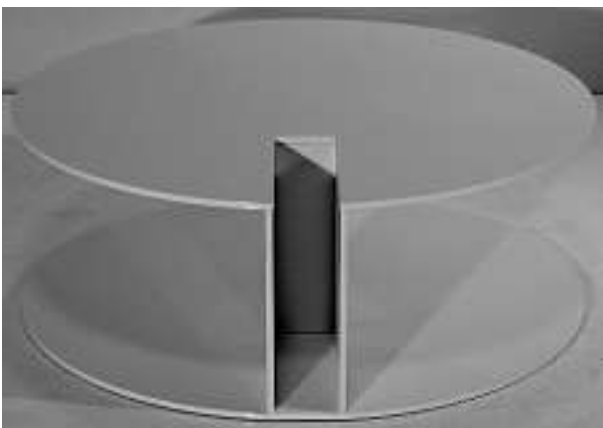



D-2080/07-S7

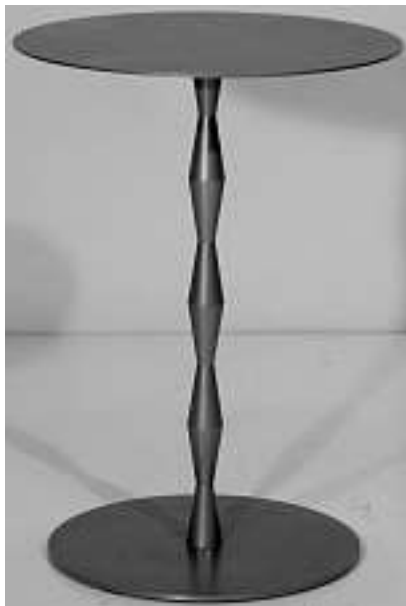

D-2080/07-S9



D-2080/07-S8





D-2080/07-S10

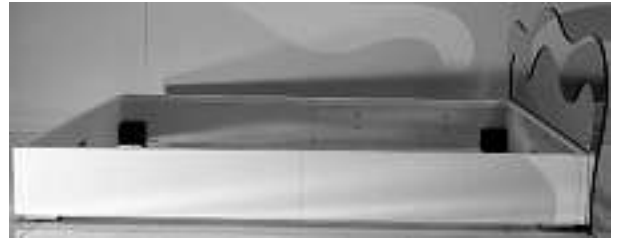

D-2080/07-S11





D-2080/07-S12

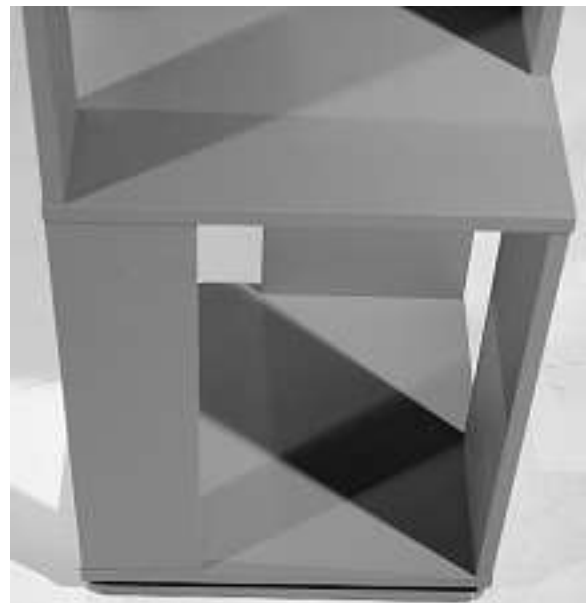
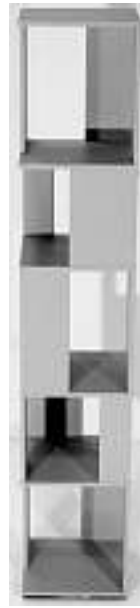

D-2080/07-S13

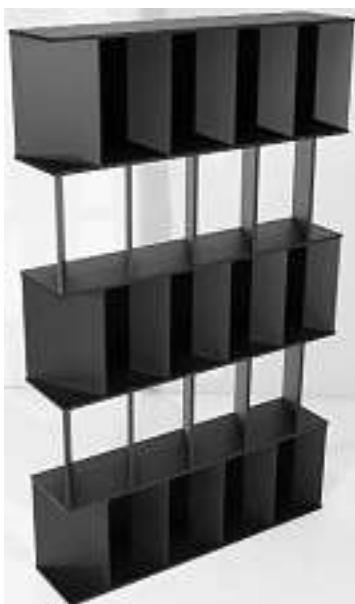



D-2080/07-S14





D-2080/07-S15





D-2080/07-S16



D-2080/07-S17



D-2080/07-S18



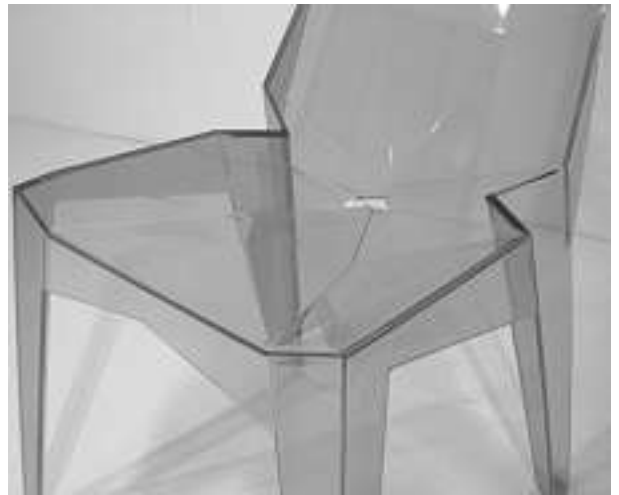

D-2080/07-S19





D-2080/07-S20





D-2080/07-S21





D-2080/07-S22



D-2080/07-S23





D-2080/07-S24



D-2080/07-S25



Cl. 07-02 **134 106** 27.06.2007

1 Design – Toaster

Hinterleger: Pi-Design AG, Kantonsstrasse 100,
6234 Triengen

Designer: Jørgen Bodum, Meggen

Vertreter: Isler & Pedrazzini AG, 8027 Zürich

Priorität: DK, 30.01.2007





M13370

Cl. 07-02 **134 107** 12.07.2007
 1 design – machine pour boissons
 Déposant: Société des Produits Nestlé SA, 1800 Vevey
 Designer: Rémy Jacquet, Le Locle; Sébastien Dassi,
 Saint-Blaise; Pierre Struzka, Lausanne
 Mandataire: Nestec S.A., 1800 Vevey



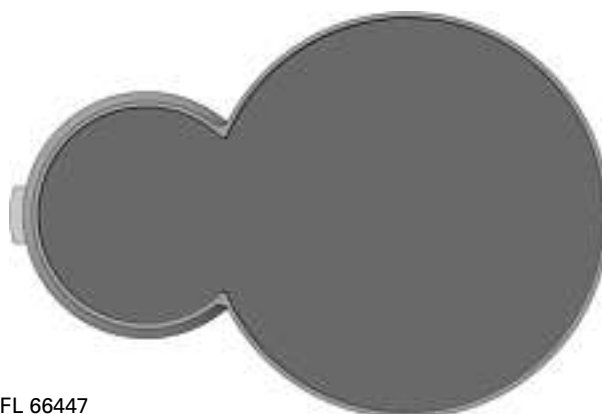
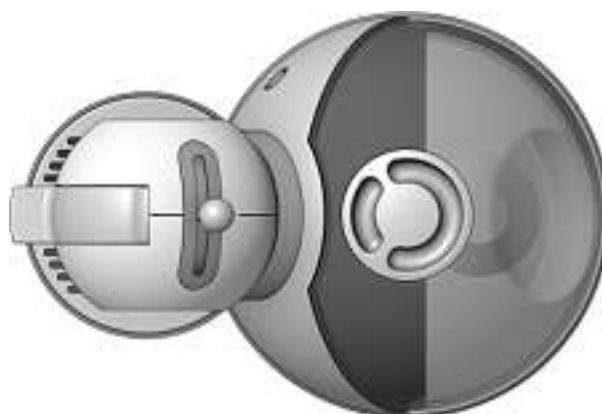

FL 66447

Cl. 09-01 134 108 18.06.2007
 1 Design – Flasche
 Hinterleger: Eliane Bollag, Belsitostrasse 18, 8044 Zürich
 Vertreter: Albiplast AG, 9244 Niederuzwil

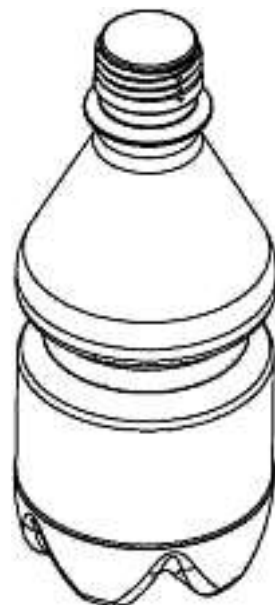
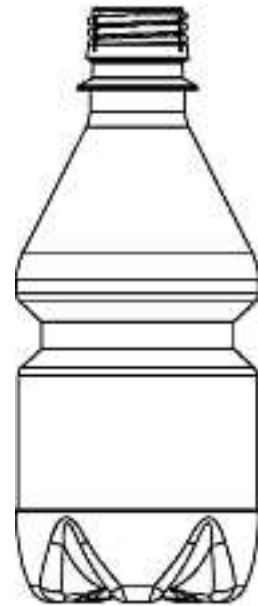
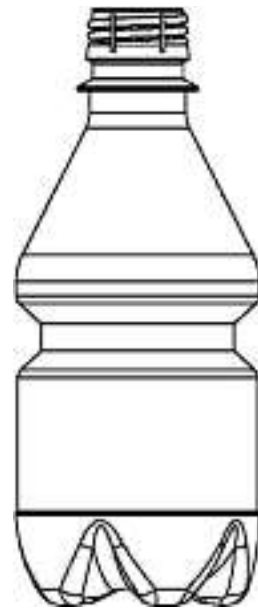

AP-DS 27005-6

Cl. 09-01 **134 109** 06.07.2007
1 design – bouteille
Déposant: Sanpellegrino S.p.A., Via Lodovico il Moro 35,
20143 Milano, IT
Designer: Luca Toson, Limena
Mandataire: Nestec S.A., 1800 Vevey
Priorité: EM, 07.05.2007

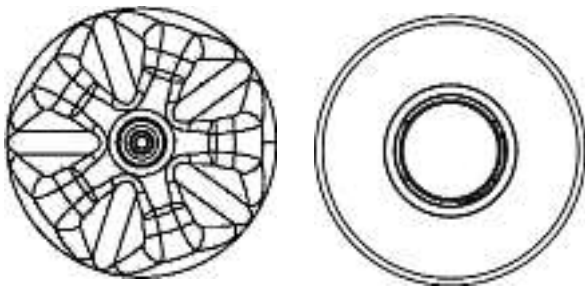

FL 66398

Cl. 09-01 **134 110** 11.07.2007
 1 Design – Kosmetikflasche
 Hinterleger: ADA Cosmetic GmbH, Im Fuchseck, 77694 Kehl, DE
 Designer: Hans Jürgen Eisenberg, Oberkirch-Bottenau
 Vertreter: Hans Rudolf Gachnang, Patentanwalt,
 8501 Frauenfeld
 Priorität: DE, 12.01.2007

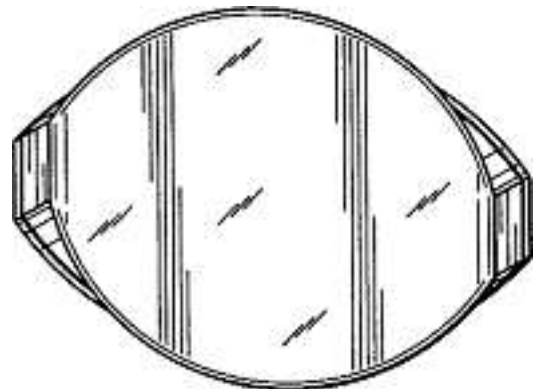
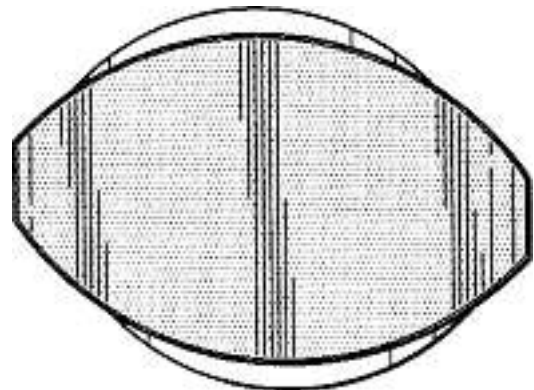
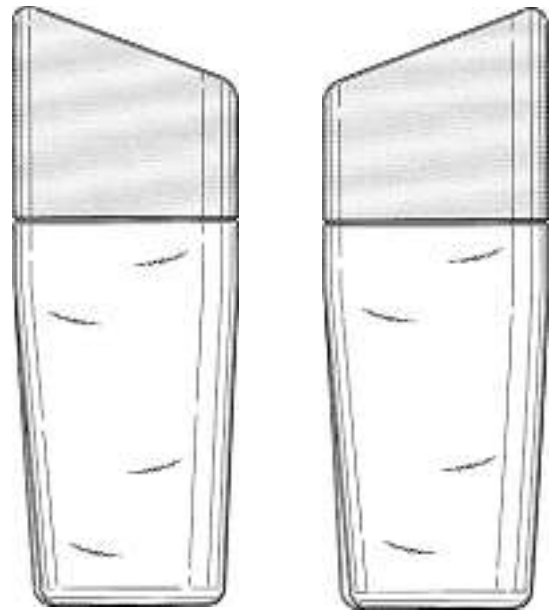
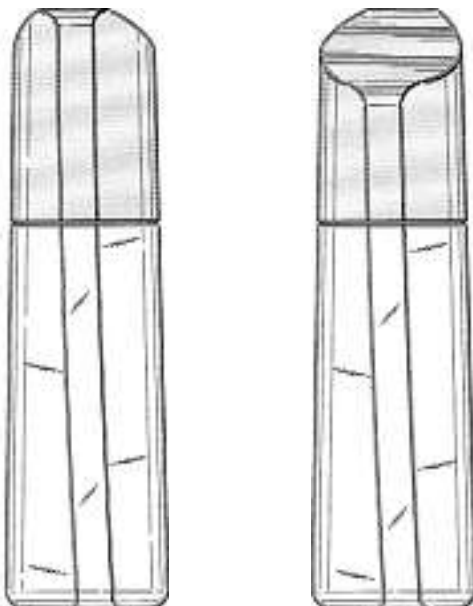
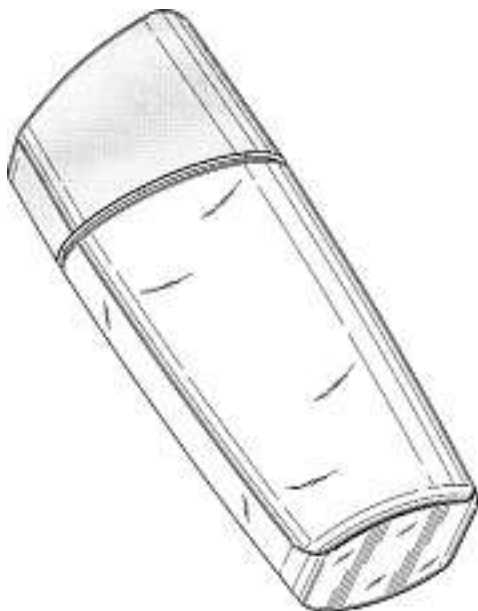

1

Cl. 09-03 **134 111** 12.07.2007
 2 Design – Transportvorrichtung
 Hinterleger: Pot Olé W.E.T. Company ApS, Roedsvej 10,
 4300 Holbaek, DK
 Designer: Ole Juul Hansen, Holbaek
 Vertreter: Isler & Pedrazzini AG, 8027 Zürich
 Priorität: EM, 02.02.2007

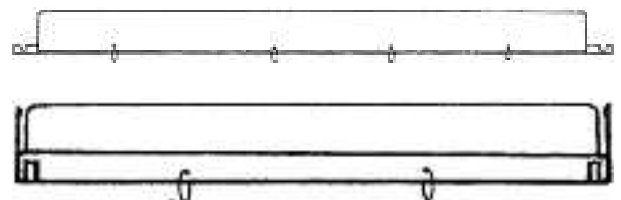



M13391-1

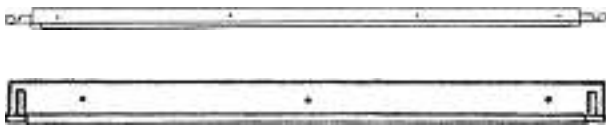
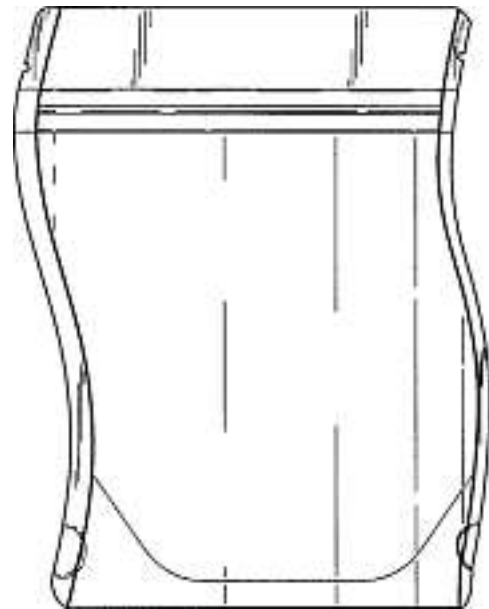
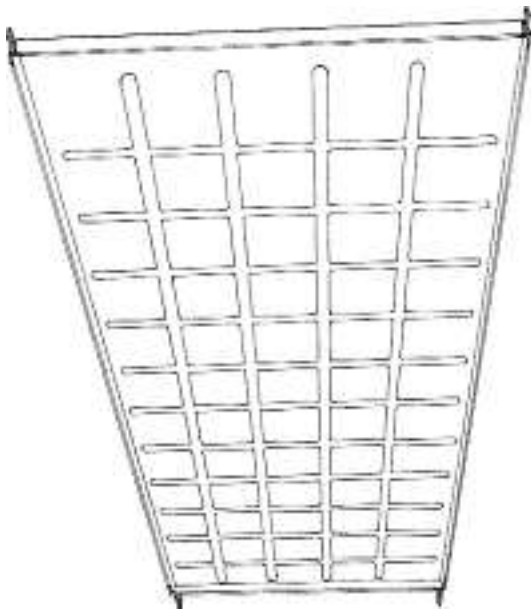
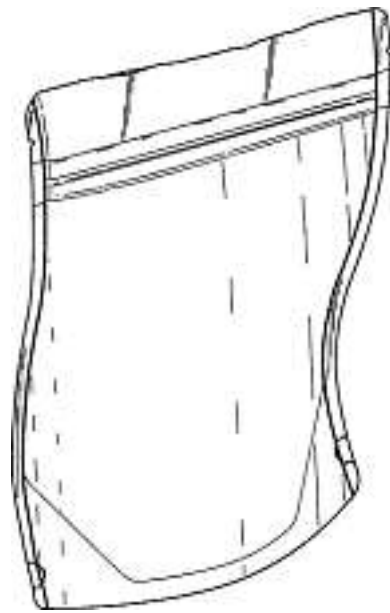

M13391-2

Cl. 09-05 **134 112** 06.07.2007
1 Design – Verpackung für Lebensmittel
Hinterleger: Unilever N.V., Weena 455, Rotterdam, NL
Designer: Valérie Zoé Alice Bernard, Paris
Vertreter: E. Blum & Co. AG, Patent- und Markenanwälte
VSP, 8044 Zürich
Priorität: FR, 26.01.2007



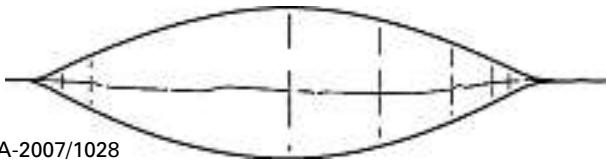

A-2007/1028

Cl. 10-04 134 116 27.06.2007

2 Design – Küchenwaage

Hinterleger: Pi-Design AG, Kantonsstrasse 100,
6234 Triengen

Designer: Jørgen Bodum, Meggen

Vertreter: Isler & Pedrazzini AG, 8027 Zürich

Priorität: DK, 25.01.2007

Beschreibung des Designs: Es ist eine Küchenwaage dargestellt mit einer Basiseinheit und einer Anzeigeeinheit, die über einen Arm schwenkbar mit der Basiseinheit verbunden ist. In der Stellung der Abbildungen 1.1 bis 1.5 liegt die Anzeigeeinheit aussen auf dem Boden einer Schüssel auf, die kopfüber über die Basiseinheit gestülpt ist. In der Abbildung 1.6 ist die Anzeigeeinheit vom Boden der Schüssel weg nach aussen geschwenkt dargestellt. In der Abbildung 1.7 liegt die Schüssel zur Durchführung des Wiegens in aufrechter Orientierung auf der Basiseinheit auf.



M13364-1



M13364-2

Cl. 10-07 134 117 25.06.2007
3 Design – Armband
Hinterleger: Cool Mountain Collection AG, Naumatthalde 9,
6045 Meggen
Designer: Fabrice Aeberhard, Affoltern am Albis;
Christian Kaegi, Zürich
Vertreter: OK pat AG, 6300 Zug

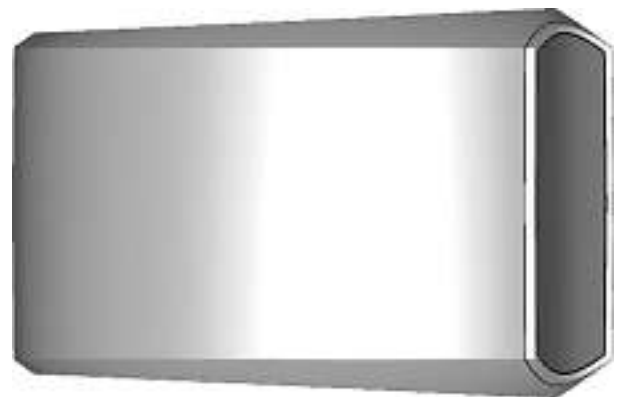
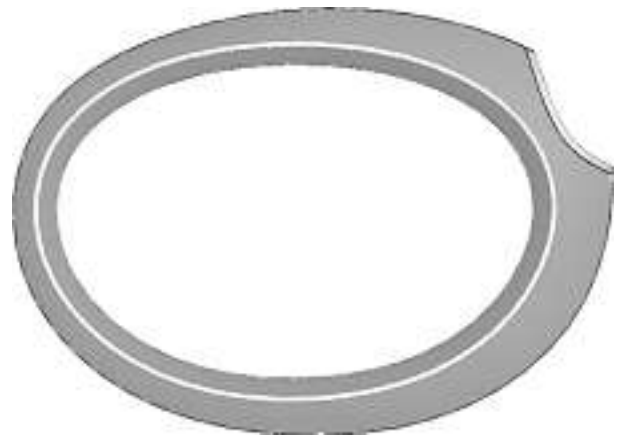



1



1



3

Cl. 10-07 **134 118** 26.06.2007

1 design – ensemble balancier-spiral

Déposant: Maurice Lacroix SA, Rue des Rangiers 21,
2350 Saignelégier

Designer: Laurent Besse, Villers Le Lac; Damien Sourice,
La Chaux-de-Fonds

Mandataire: MICHELI & CIE SA, 1226 Thônex

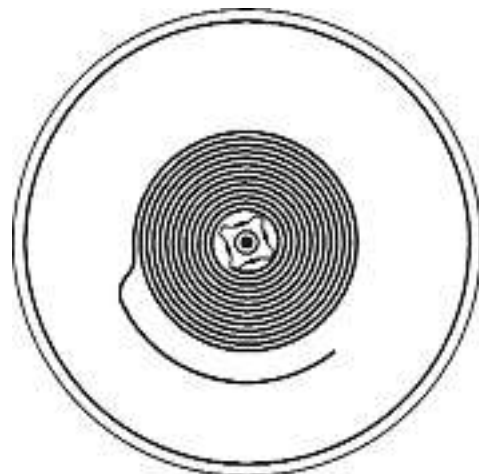

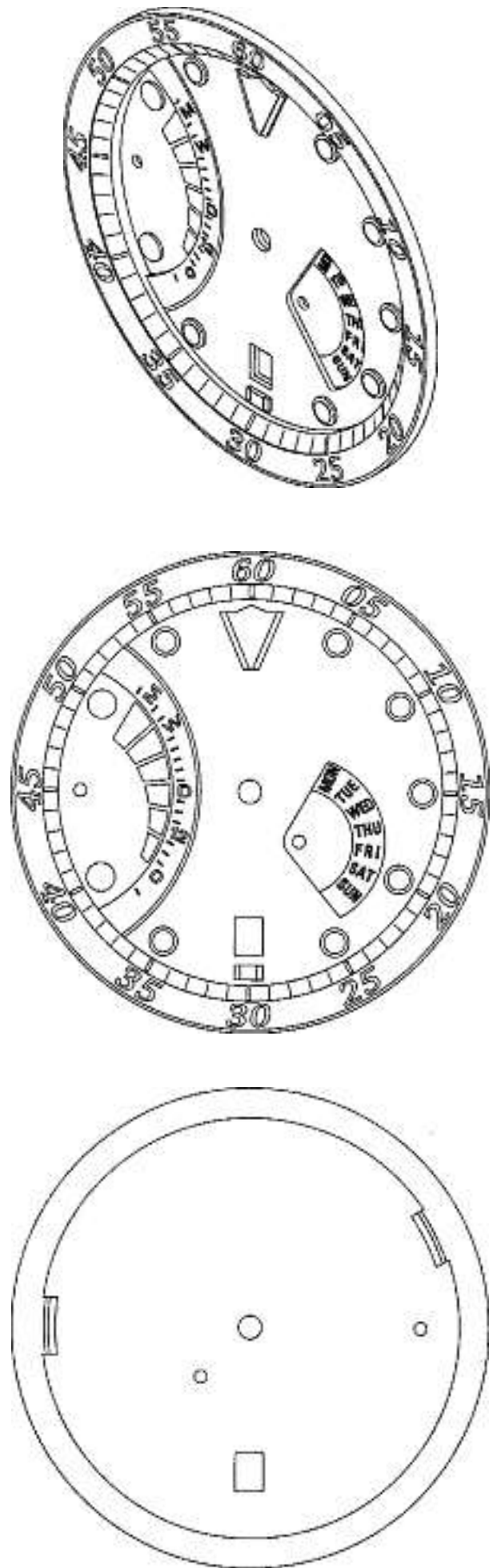
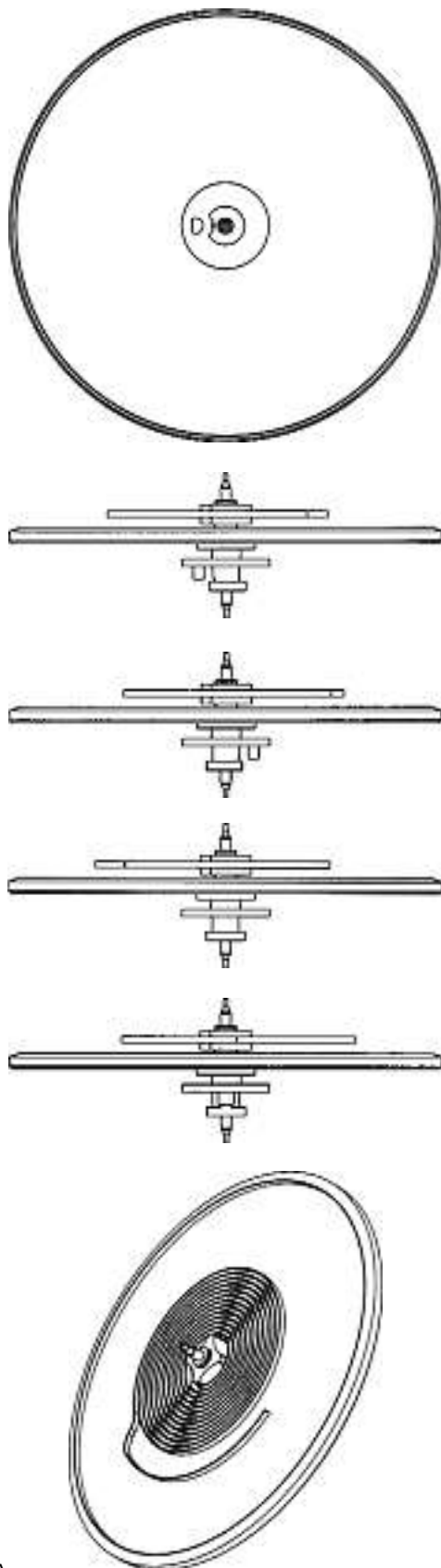

15020A

Cl. 10-07 **134 119** 10.07.2007
 3 Design - Uhrengehäuse und Uhrenzifferblätter
 Hinterleger: Seiko Watch Kabushiki Kaisha (trading as Seiko Watch Corporation), 2-1, Shibaura 1-chome, Minato-ku, Tokyo, JP
 Designer: Katsunori Kume, Tokyo
 Vertreter: Bovard AG, 3000 Bern 25
 Priorität: JP, 12.01.2007; JP, 12.01.2007; JP, 12.01.2007

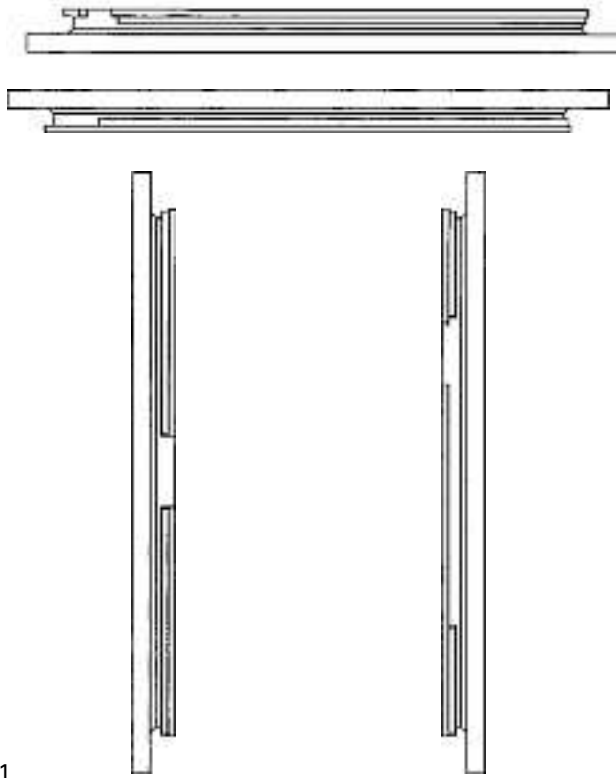

1

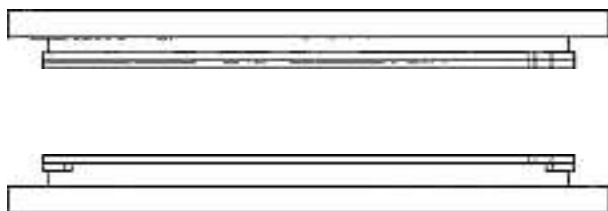
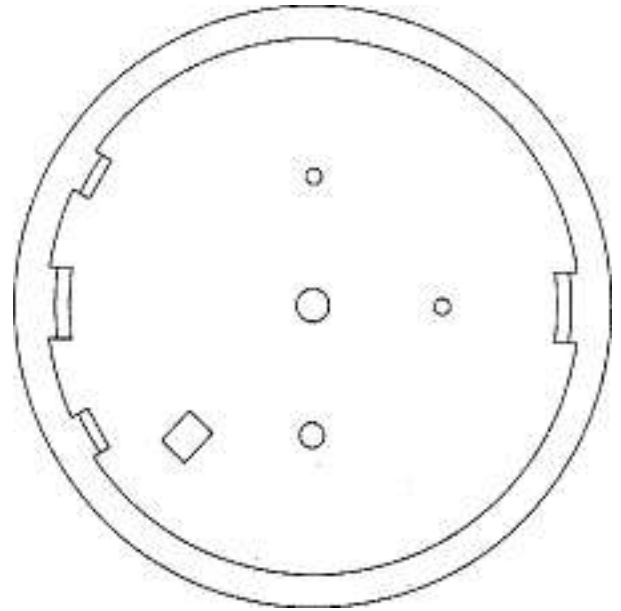
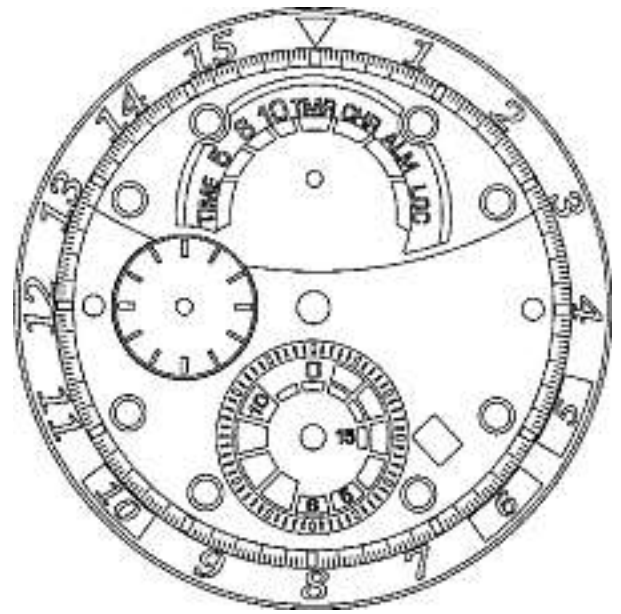

2

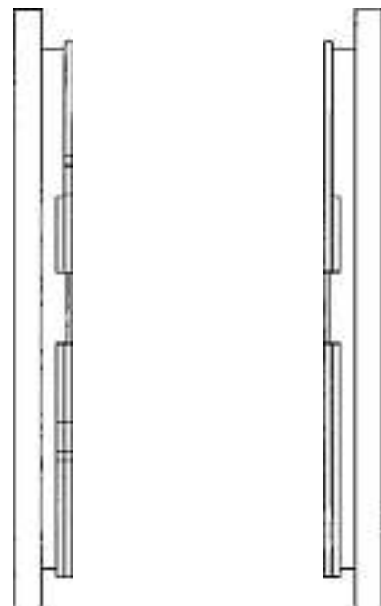

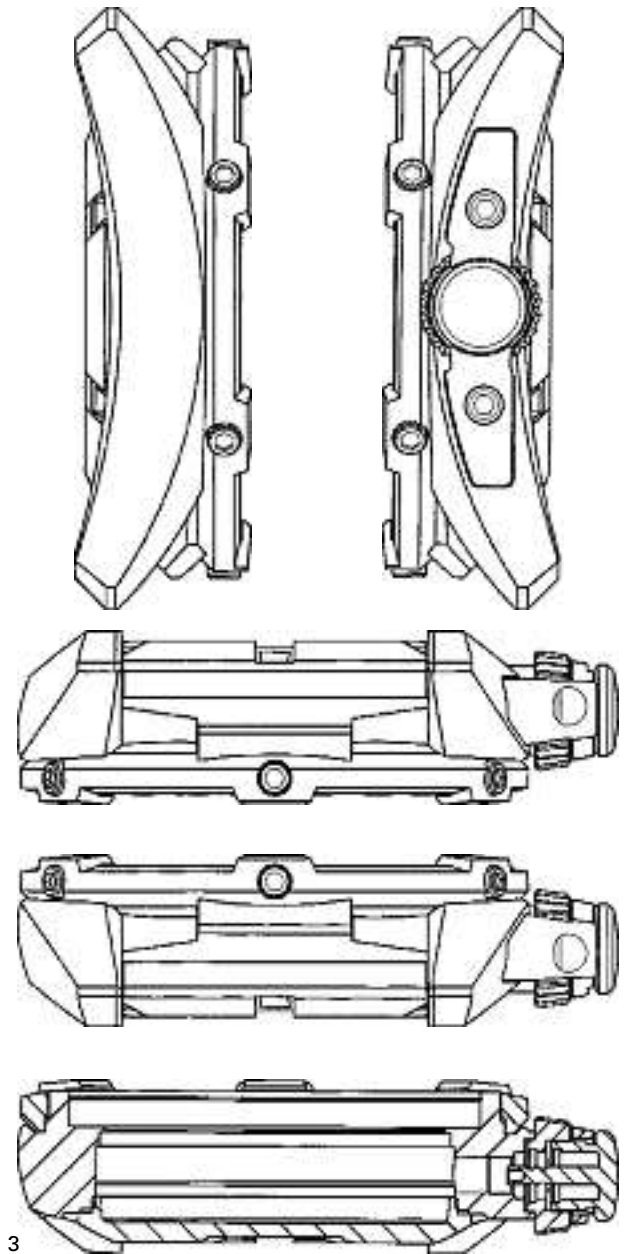
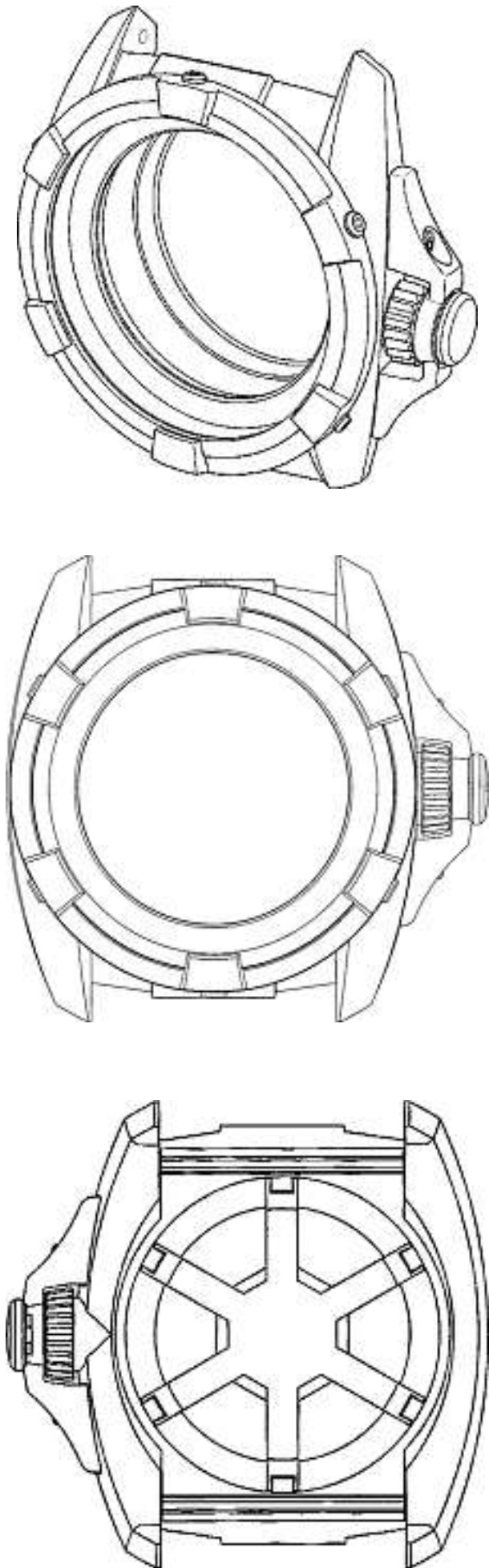

3

Cl. 11-01 134 120 30.05.2007
1 Design – Anhänger
Hinterleger: gim6.ch, Im Lingg 2, 8800 Thalwil
Designer: Arlette Halter, Thalwil





1000

Cl. 11-01 **134 121** 31.05.2007
 7 Design – Haar- und Fingerschmuck
 Hinterleger: Lenherr's Dessert-Show, Bächi 4, 6422 Steinen
 Designer: René Lenherr, Steinen
 Beschreibung des Designs: «Röhrenartiger Haar- und Fingerschmuck, welcher gedreht, gewendet gerollt, geknüpft, individuell verziert, geflochten, gewickelt, gekantet, gestrickt, geschraubt, in die Haare oder an die Finger angebracht werden kann. Material bestehend aus Papier, Pappe, Leder, Metall, Kunststoffen, Gummi, Holz, Rohren, Kork, Stahl, Seilen, Garnen, Fäden, Wolle, Textilien, Jeans, Stickerein, Spitzen.»



1



2



3



4



5



6



7

Cl. 11-02 134 122 14.06.2007
1 Design – Ziergegenstand
Hinterleger: Stilfabrik AG, Gäuggelistrasse 25, 7001 Chur
Designer: Simone Peters, Wilen bei Wollerau
Vertreter: Meyer & Kollegen, 7000 Chur
Priorität: EM, 20.12.2006





2497CHM

Cl. 12-08 134 123 27.06.2007

1 design – autovettura

Depositante: Ferrari S.p.A., Via Emilia Est, 1163, Modena, IT

Designer: Nikolas Tombazis, Castelnovo Rangone

Mandatario: Jacobacci & Partners S.A., 1207 Genève

Priorità: IT, 11.01.2007

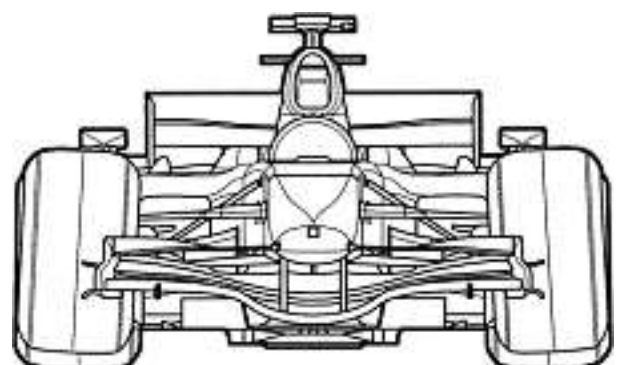
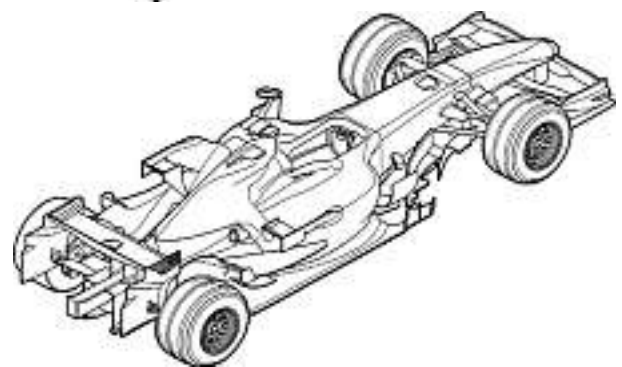
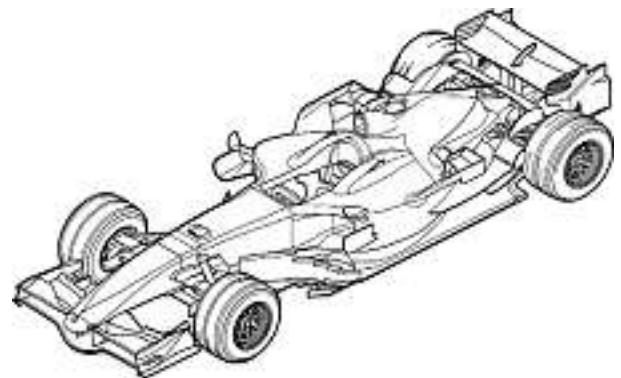

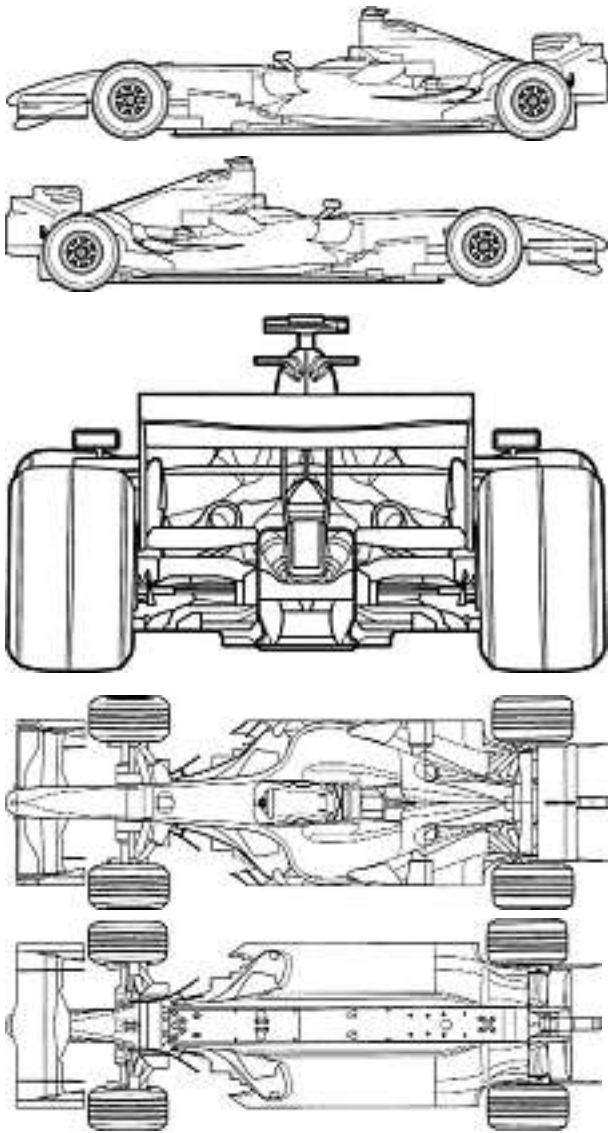

D-2082/07

Cl. 12-16 134 124 14.06.2007

3 Design – Auspuffendrohre

Hinterleger: Dr.Ing. h.c.F. Porsche Aktiengesellschaft,
Porscheplatz 1, 70435 Stuttgart, DE

Designer: Claus-Dieter Unfried, Markgroeningen;
Robert Owen, Niefern-Oeschelbronn

Vertreter: Isler & Pedrazzini AG, 8027 Zürich

Priorität: DE, 22.12.2006; DE, 22.12.2006; DE, 22.12.2006

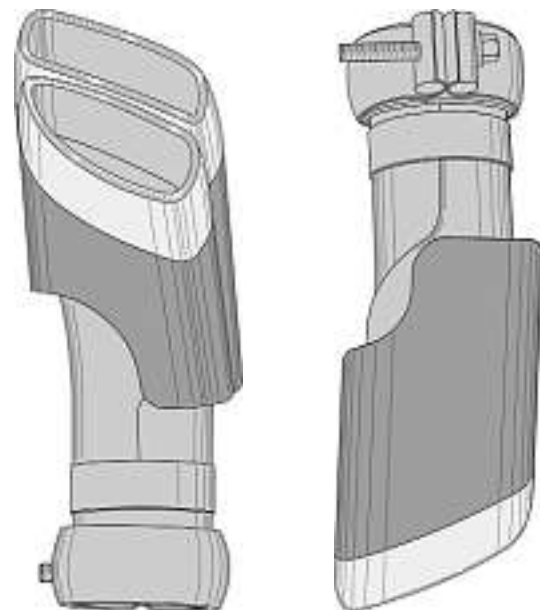
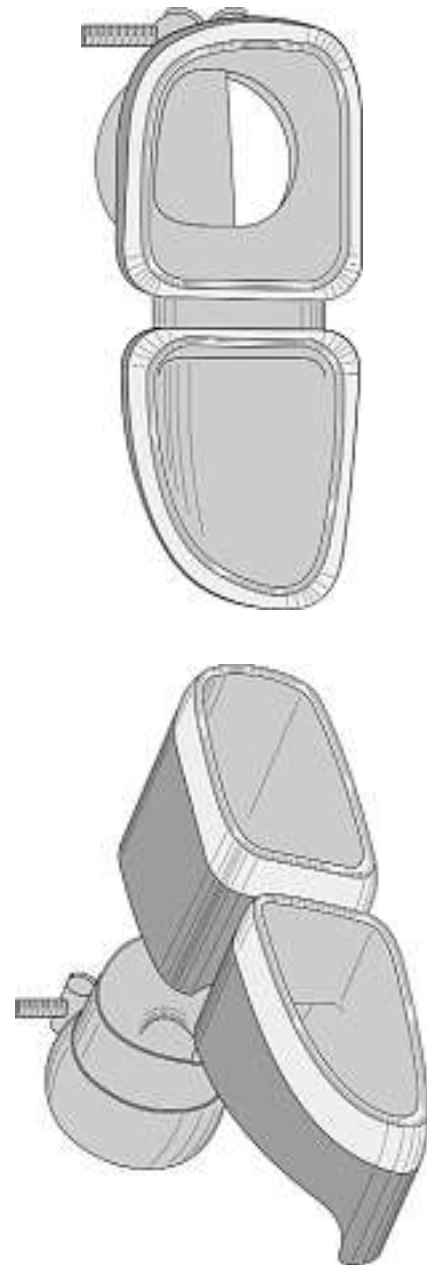
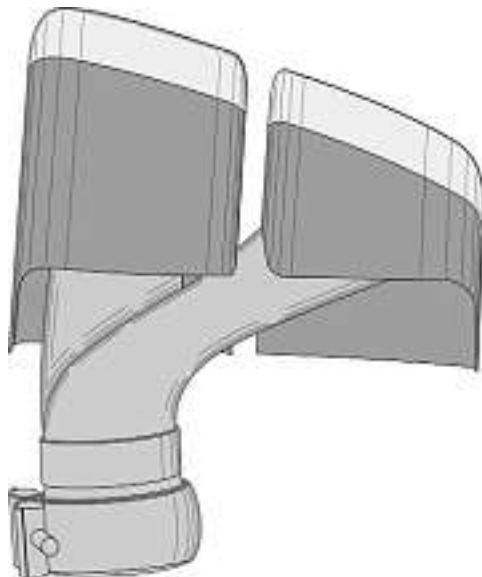

M13356-1

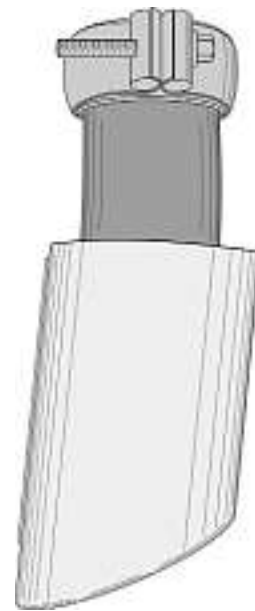
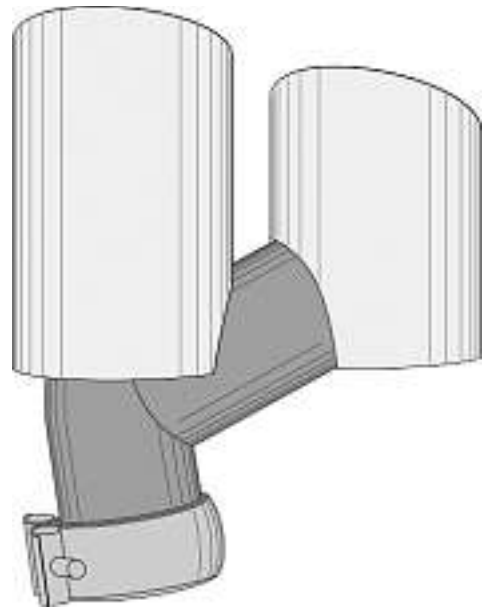
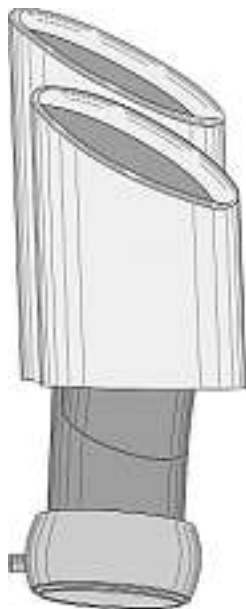
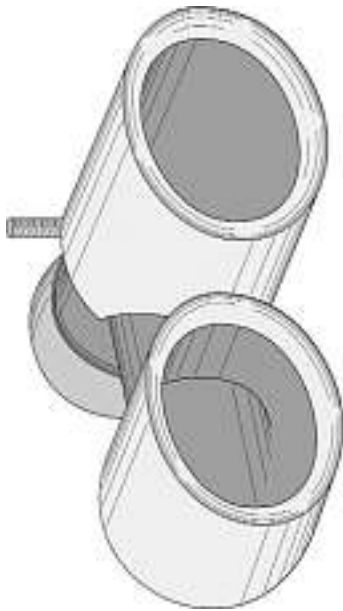
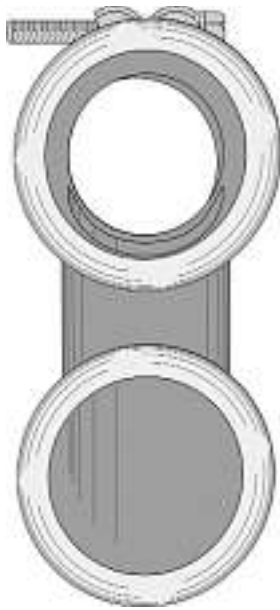

M13356-2

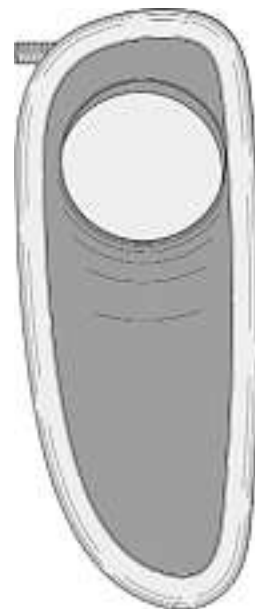

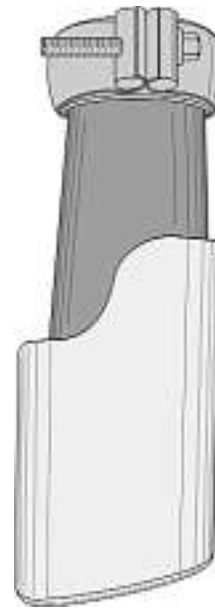
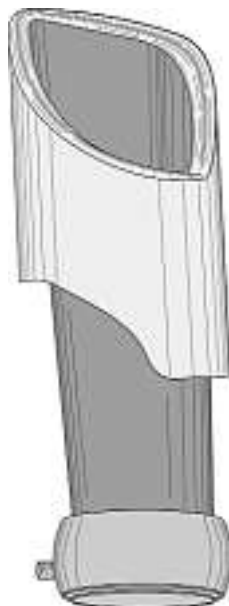
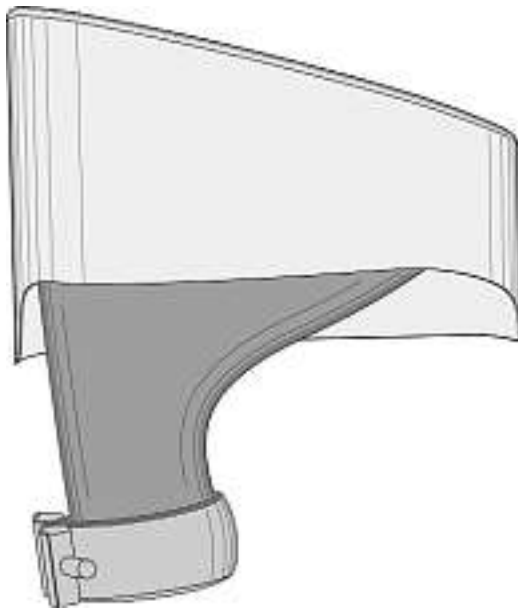
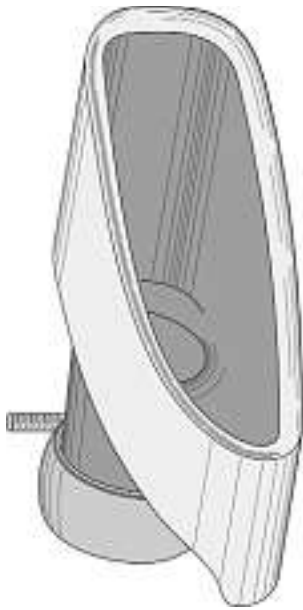

M13356-3

Cl. 13-03 134 128 03.07.2007
2 design – coupe-circuit
Déposant: Sécheron SA, Rue du Pré-Bouvier 25, 1242 Satigny
Designer: Petr Babka, Praha; Richard Hába, Praha
Mandataire: MICHELI & CIE SA, 1226 Thônex
Priorité: RU, 16.03.2007

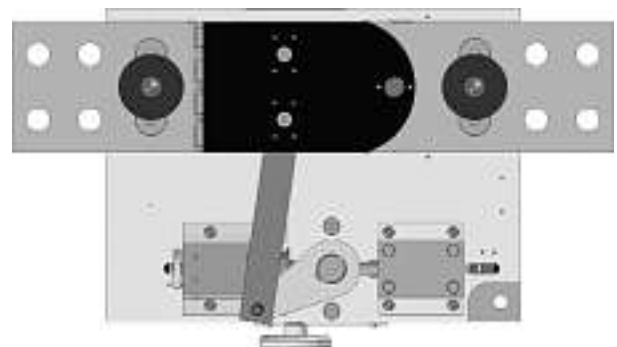
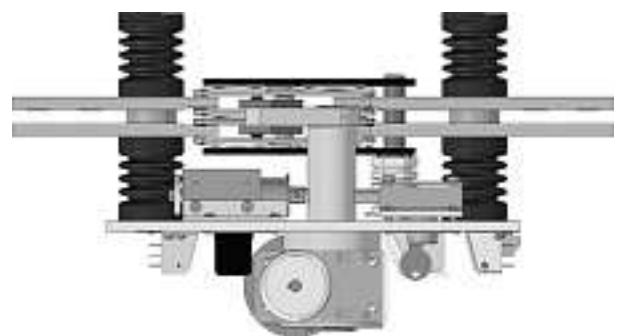
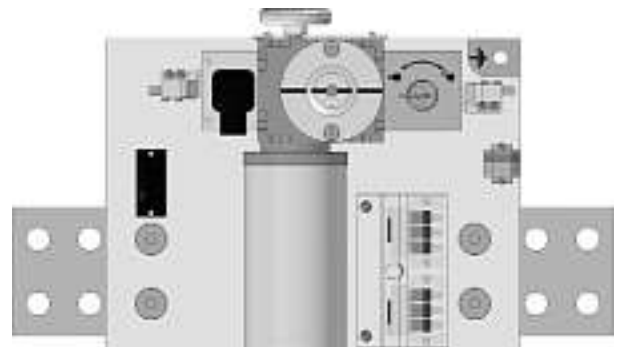

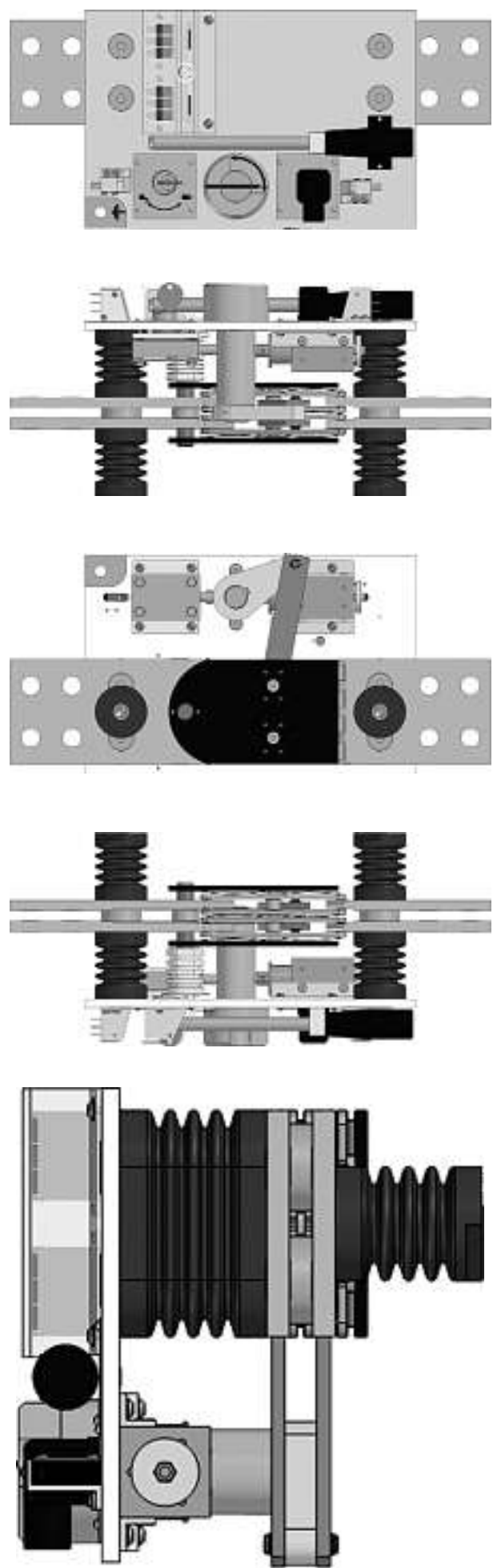
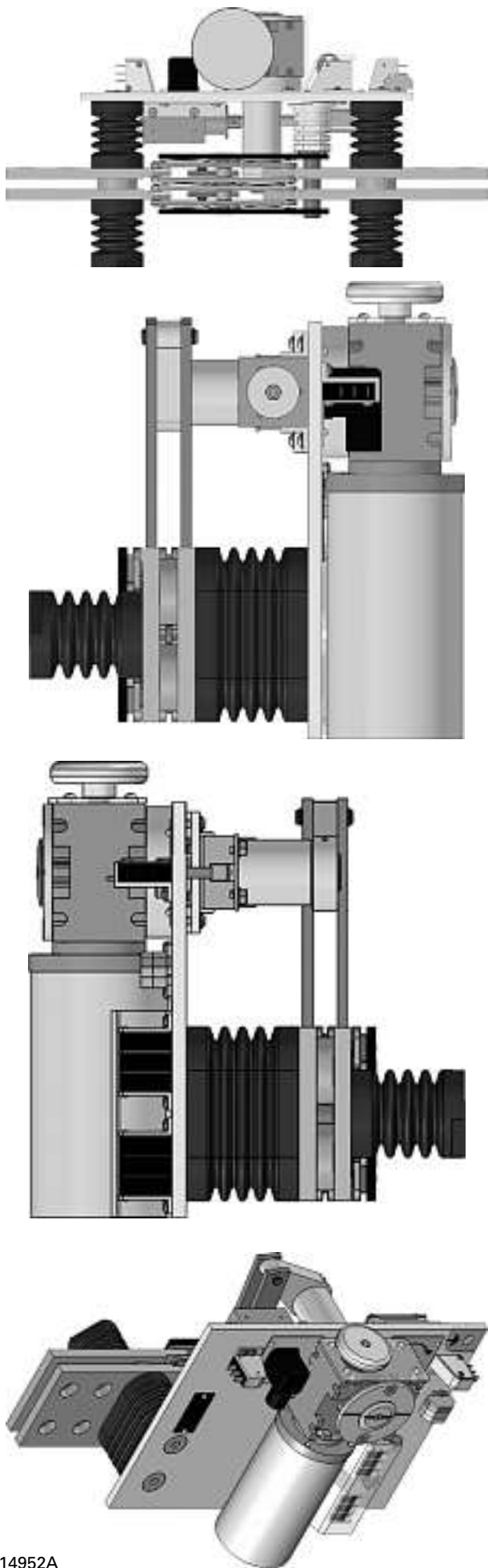

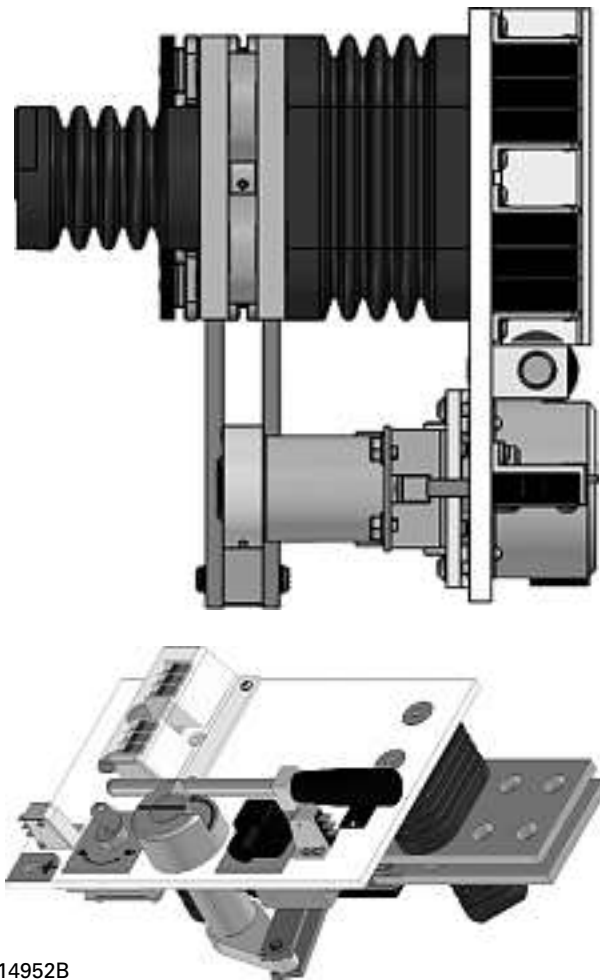

14952B

Cl. 14-03 **134 129** 27.06.2007
1 design – tuner pour télévision
Déposant: Sony Computer Entertainment Inc., 2-6-21,
Minami-Aoyama, Minato-ku, Tokyo, JP
Designer: Naoto Shimizu, Tokyo
Mandataire: MICHELI & CIE SA, 1226 Thônex
Priorité: JP, 05.02.2007

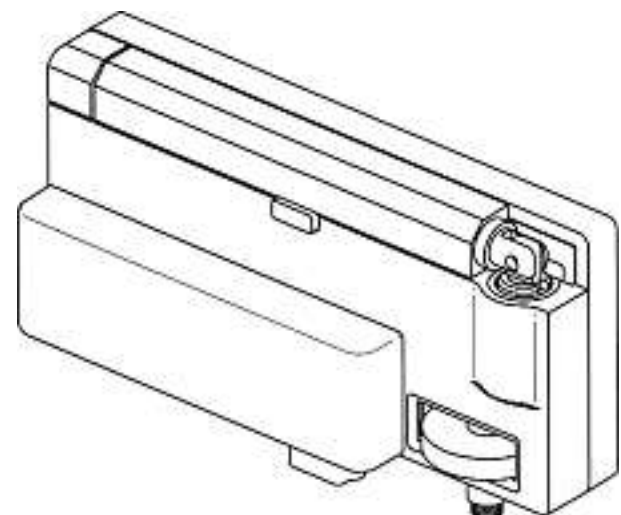
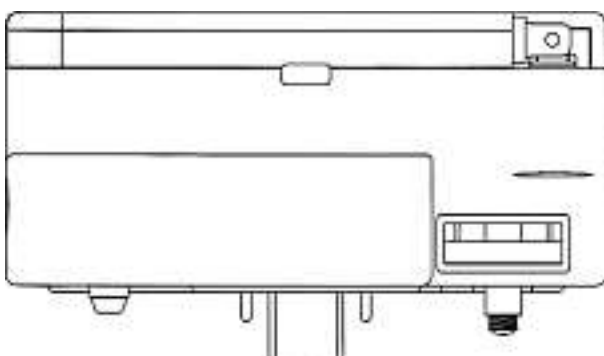
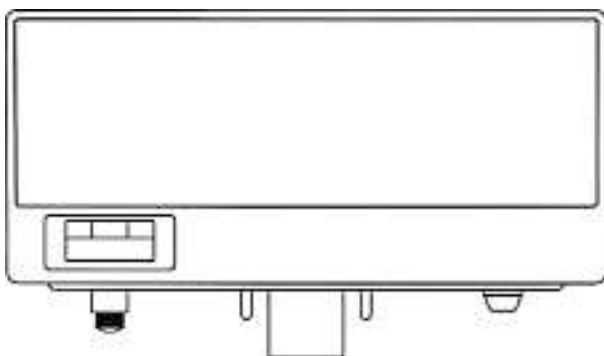
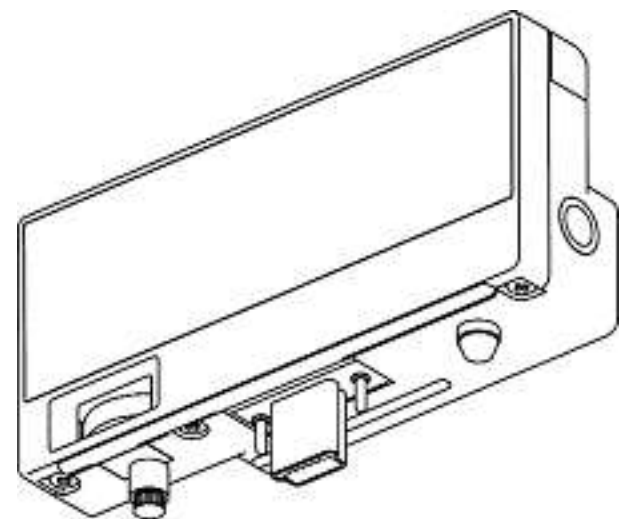
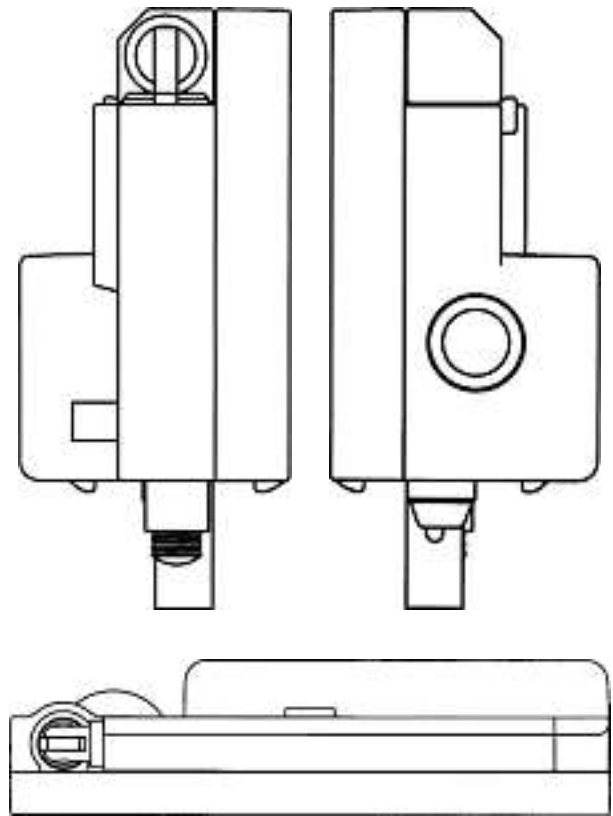

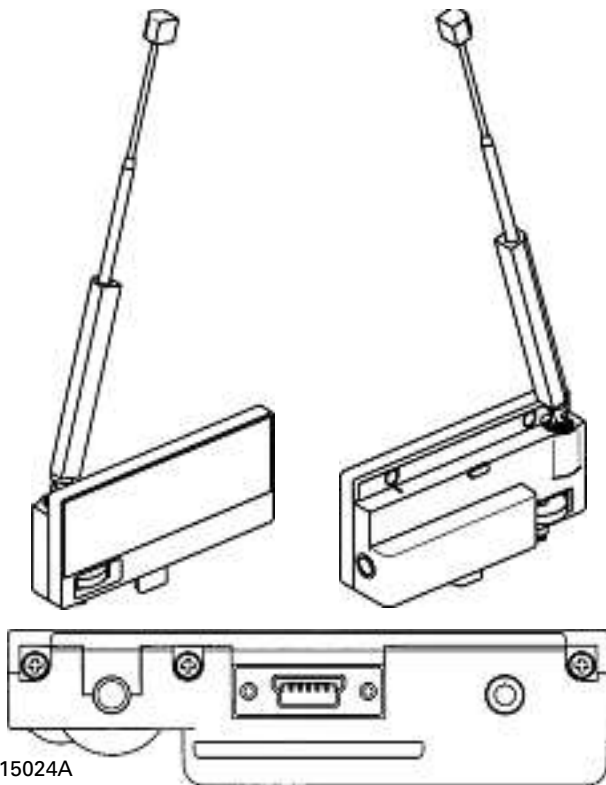

15024A

Cl. 14-04 **134 130** 03.07.2007
 1 Design – graphische Benutzeroberfläche
 Hinterleger: Veronika Barczak, Anetswilerstrasse 16,
 9545 Wängi



ISO Schutz

Cl. 21-01 **134 131** 27.06.2007
 1 design – autovettura giocattolo
 Depositante: Ferrari S.p.A., Via Emilia Est, 1163, Modena, IT
 Designer: Nikolas Tombazis, Castelnuovo Rangone
 Mandatario: Jacobacci & Partners S.A., 1207 Genève
 Priorità: IT, 11.01.2007

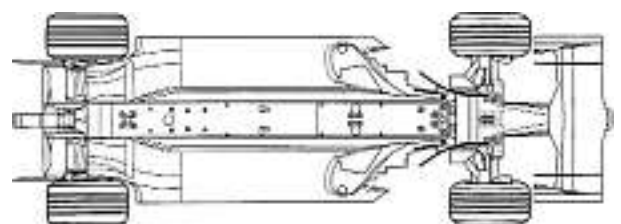
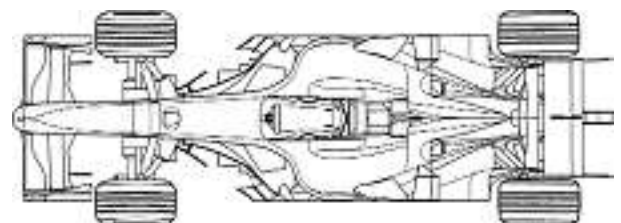
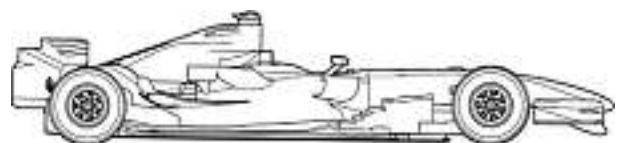
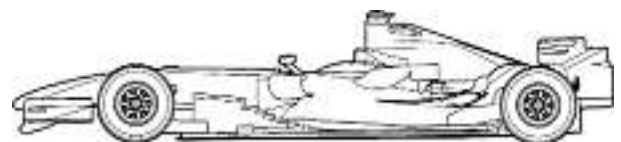
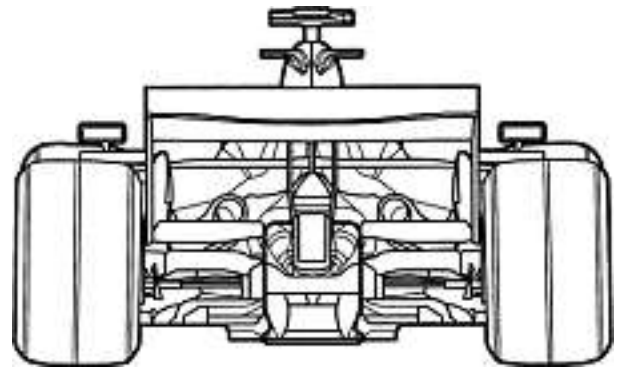
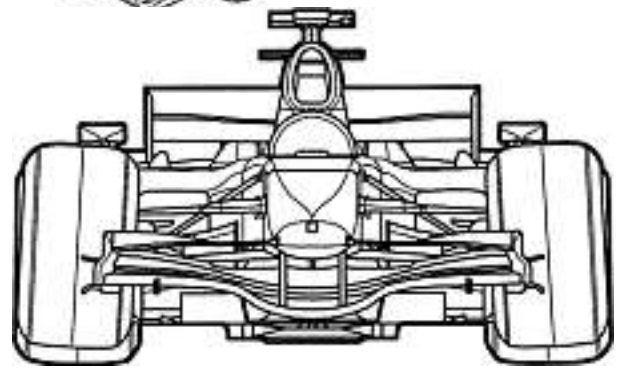
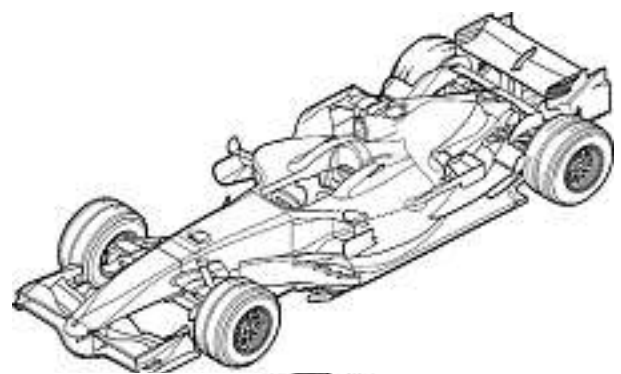
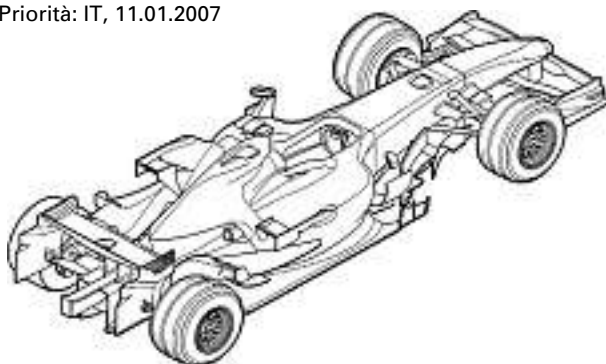

D-2081/07

Cl. 21-04 134 132 01.06.2007
8 Design – Innenhimmel für Pagoden- und Pavillon-Zelte
Hinterleger: HMS Event Service GmbH, Salzstrasse 190,
Heilbronn, DE
Designer: Klaus Hampp, Heilbronn
Vertreter: Isler & Pedrazzini AG, 8027 Zürich
Priorität: DE, 03.04.2007



M13355-1

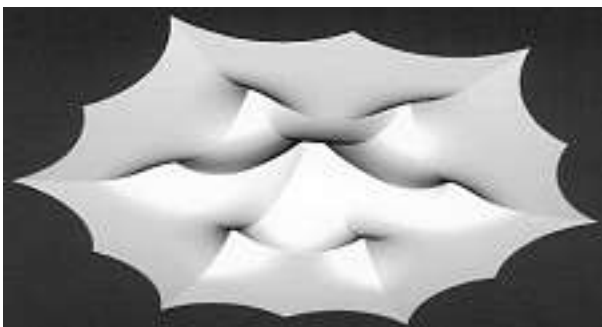

M13355-2



M13355-3

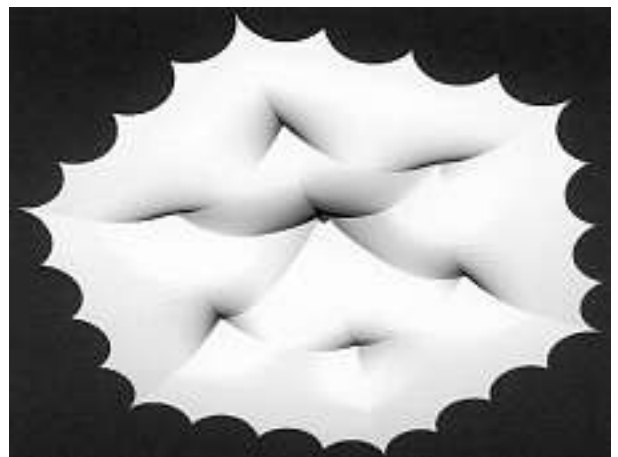

M13355-4



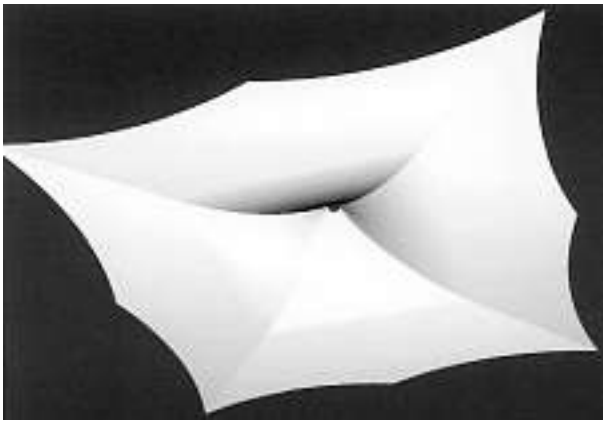

M13355-5

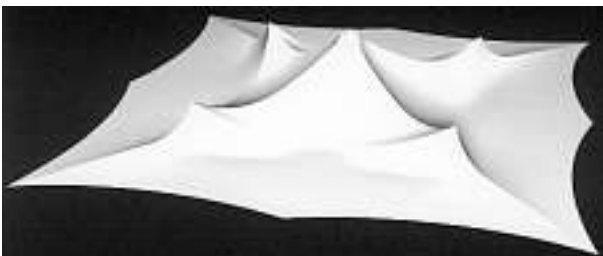
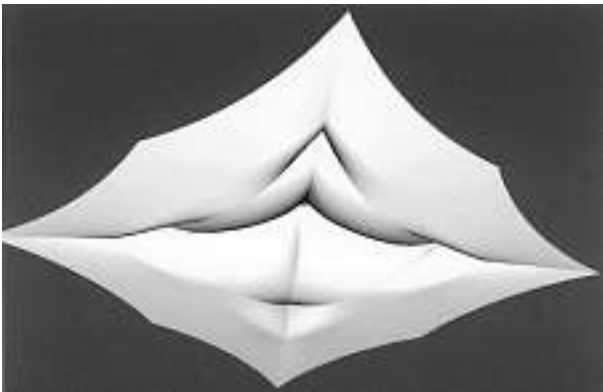

M13355-6



M13355-7



M13355-8

Cl. 23-01 **134 133** 26.06.2007
1 Design – Wasseraufbereiter
Hinterleger: PrimAqua AG, Bächtoldstrasse 4, 8044 Zürich
Designer: Frank Fischer, Deggendorf

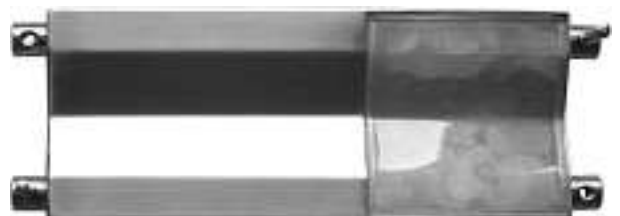



FF08

Cl. 23-01 134 134 26.06.2007
1 Design – Wasseraufbereiter
Hinterleger: PrimAqua AG, Bächtoldstrasse 4, 8044 Zürich
Designer: Frank Fischer, Deggendorf

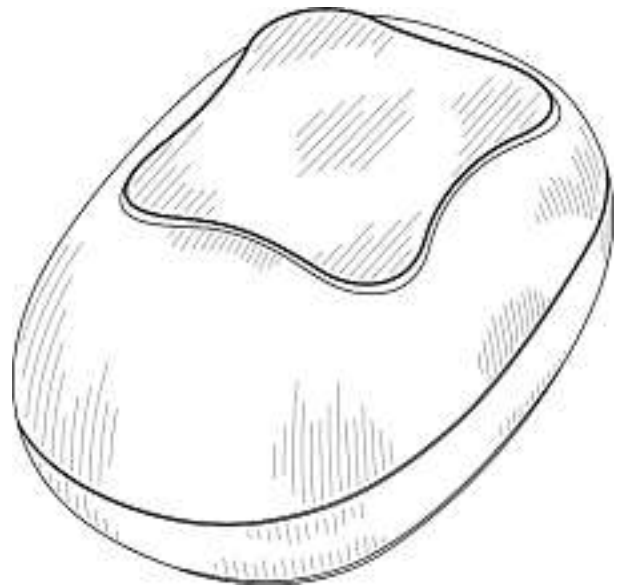

Vitali

Cl. 24-02 134 136 27.06.2007
3 Design – Brustpumpe
Hinterleger: Medela Holding AG, Lättichstrasse 4b, 6340 Baar
Designer: Jill Solberg, Woodstock
Vertreter: Isler & Pedrazzini AG, 8027 Zürich

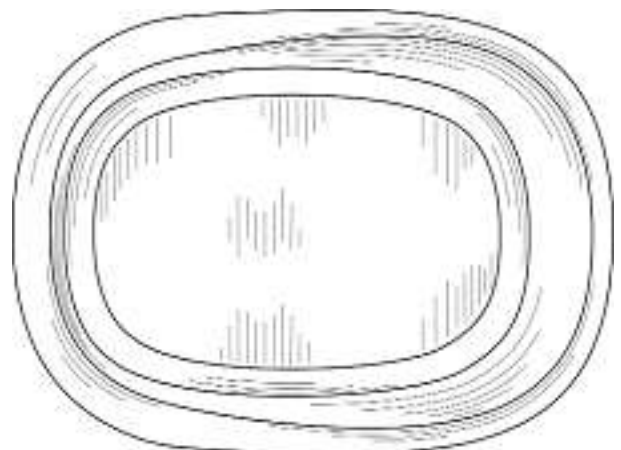
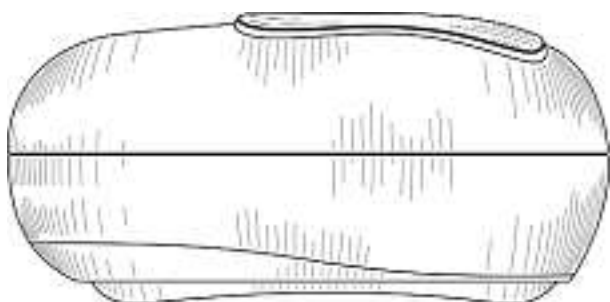
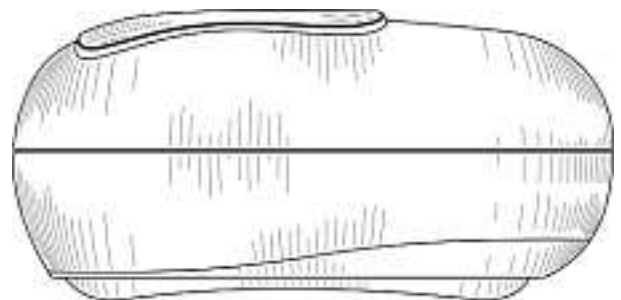
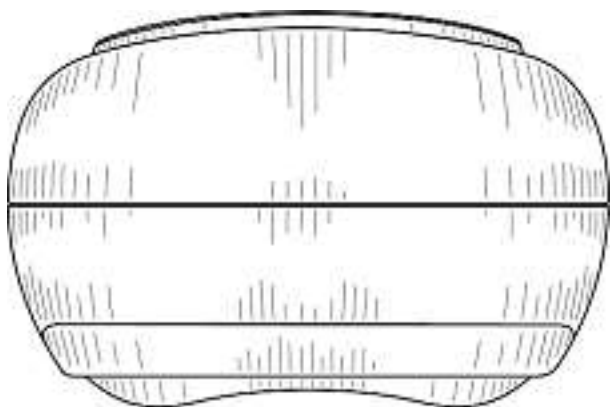
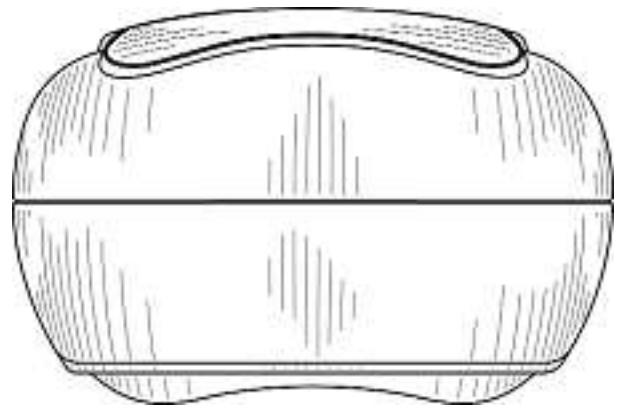

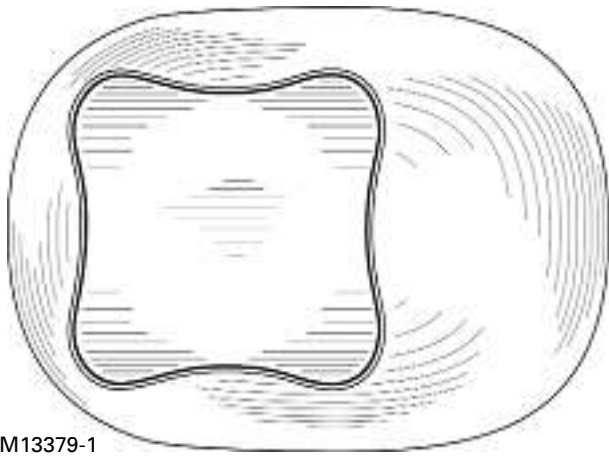

M13379-1

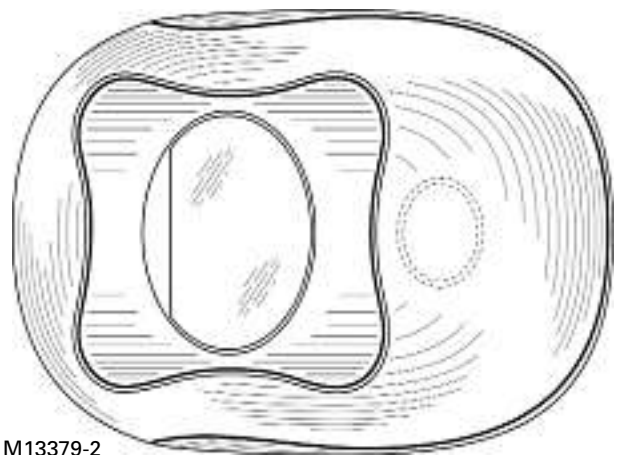
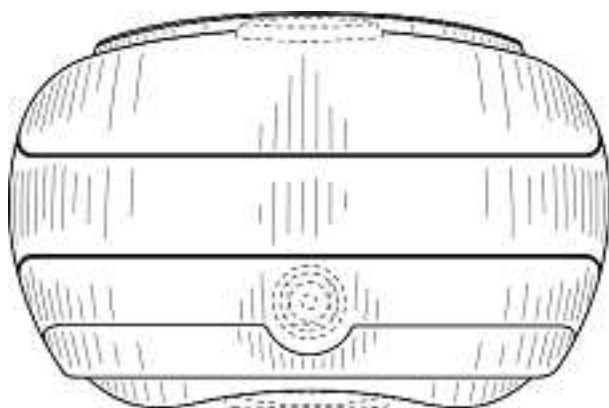
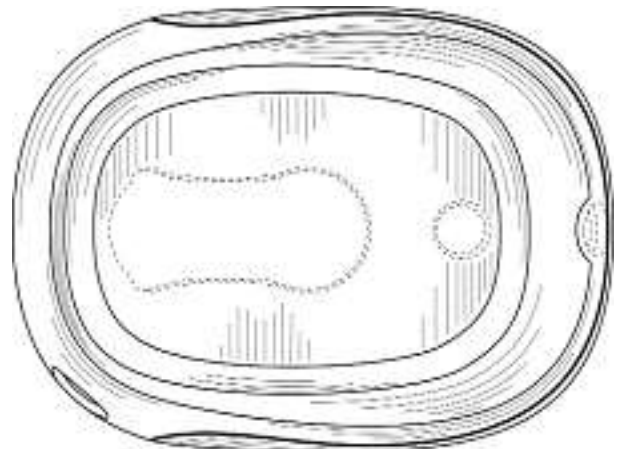
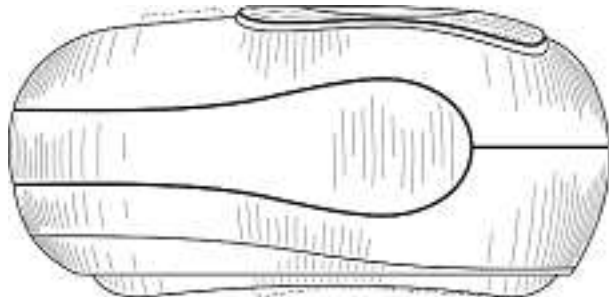
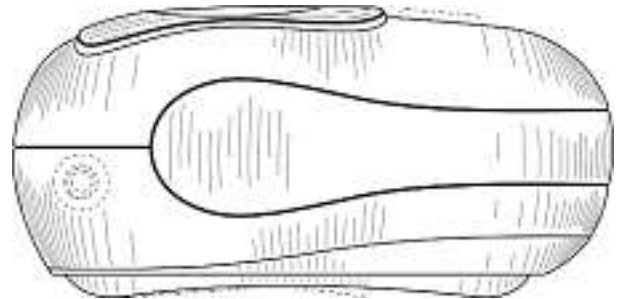
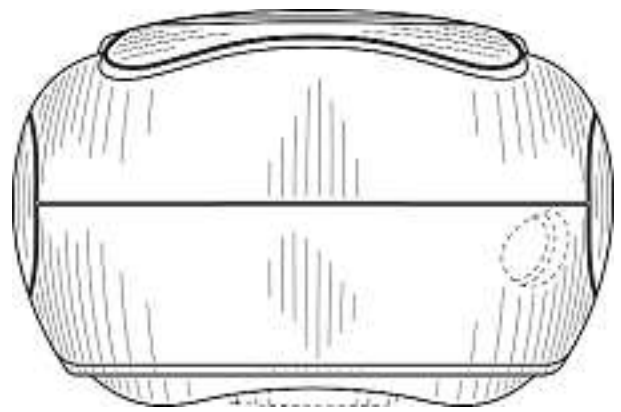

M13379-2

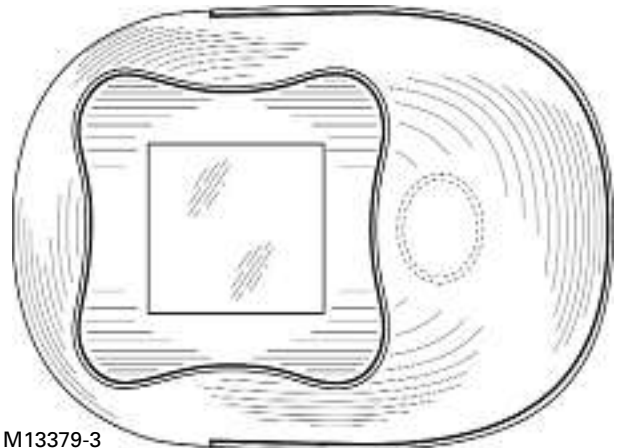
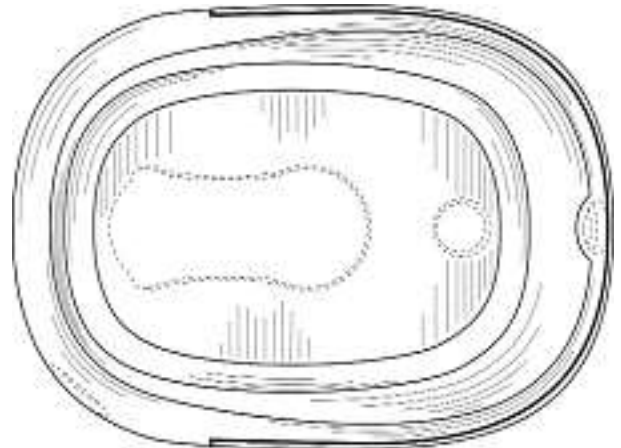
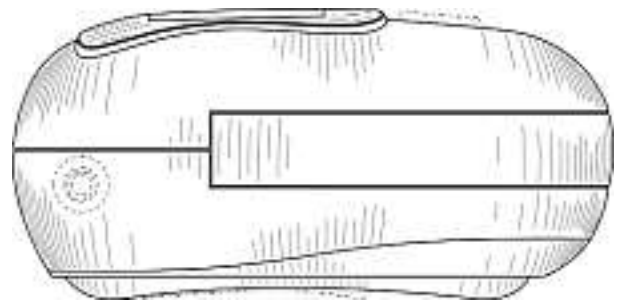
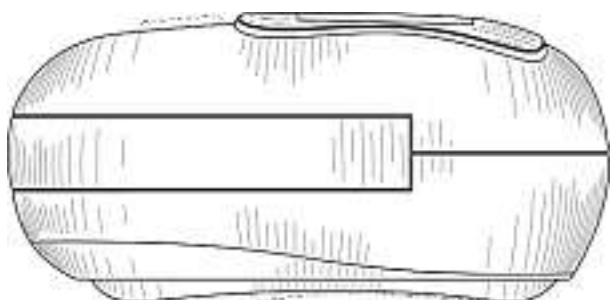
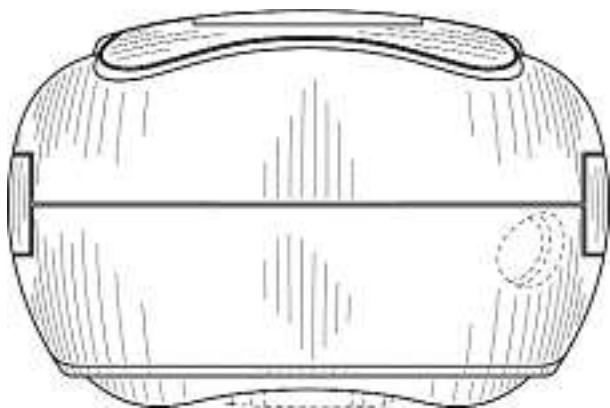
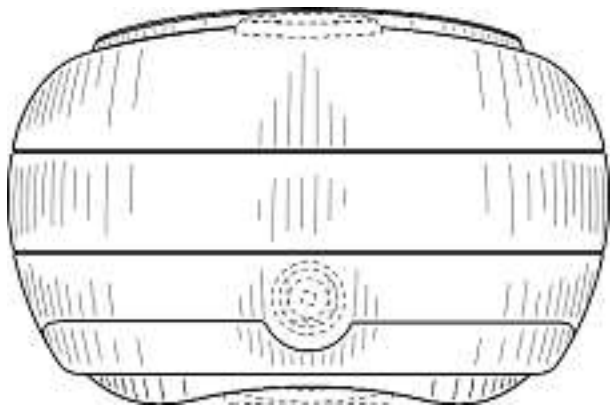

M13379-3

Cl. 24-02 134 137 28.06.2007

1 design – porte-aiguille

Déposant: Cum Suis BNT B. V., Dr. Molewaterplein 40, 3015 GD Rotterdam, NL

Designer: Paulus Cornelius Helder, Breda; Rudolf Eduard Kraan, Stein; Mauritius Johannes Mathijs Maria Roost, Landgraaf

Mandataire: Bugnion S.A., 1211 Genève 12 - Champel
 Priorité: EM, 10.04.2007

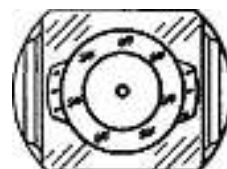
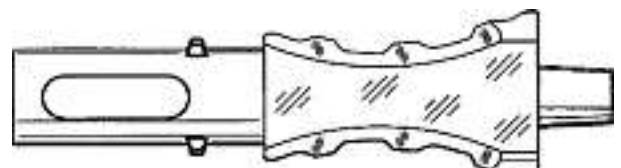

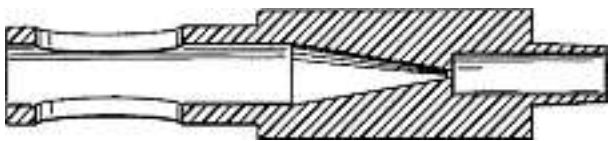
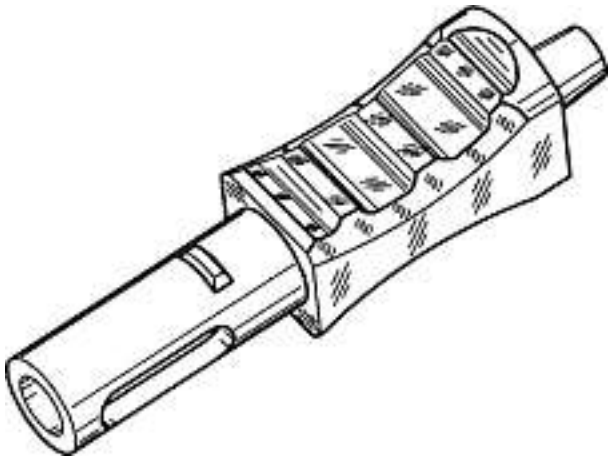
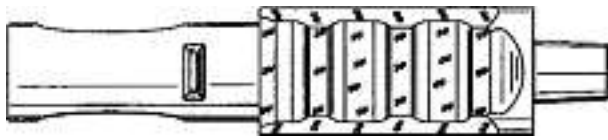

1

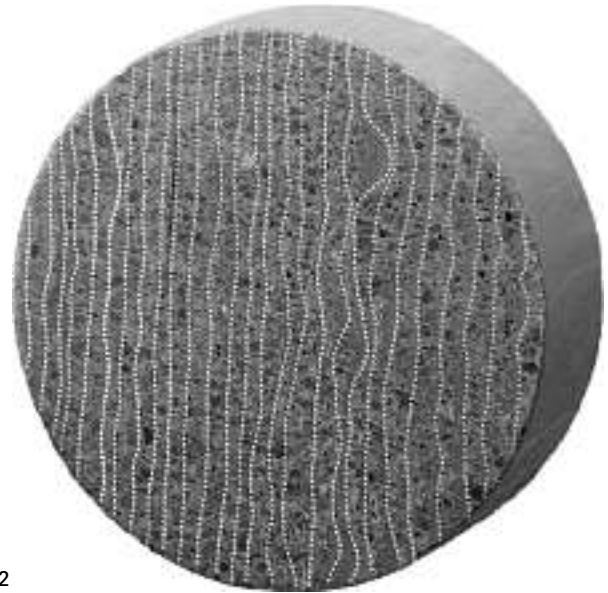

2

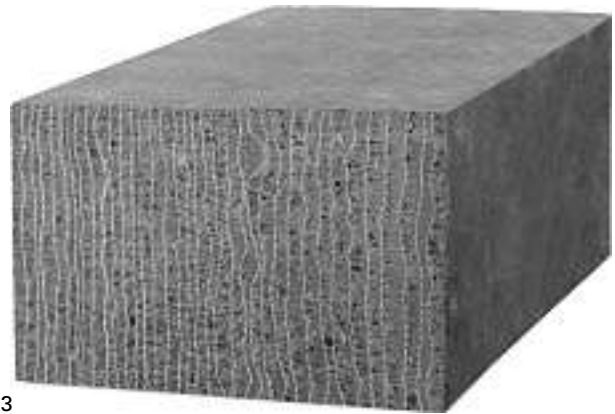

3

Cl. 25-01 **134 138** 12.07.2007
 3 Design – Bausteine
 Hinterleger: LUCCON Lichtbeton GmbH, Andreas-Hofer-
 Strasse 8, 6890 Lustenau, AT
 Designer: Jürgen Frei, Dornbirn
 Vertreter: Schneider Feldmann AG, Patent- und
 Markenanwälte, 8022 Zürich
 Priorität: DE, 20.01.2007

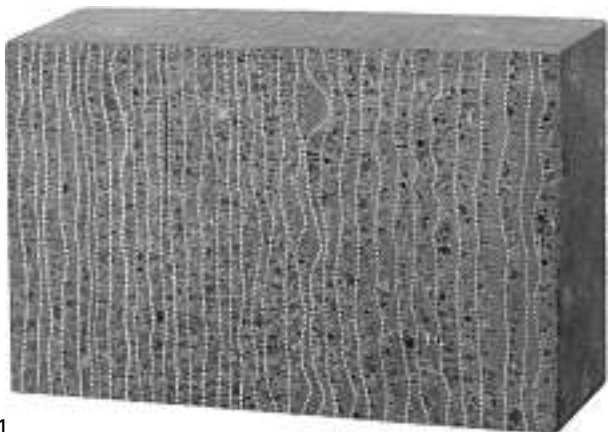

1

Cl. 27-02 **134 141** 04.07.2007
 1 Design – Wasserpfeife
 Hinterleger: Marc Müller, Jungfraustrasse 5, 3661 Uetendorf



DLB-07

Cl. 99-00 134 142 02.07.2007
1 Design – Urne
Hinterleger: URNE.CH Schär & co, Schwandenholzstrasse
186a, 8046 Zürich
Designer: Thomas Schär, Zürich



towano 07

Verlängerungen Prolongations Prolongazioni

119 917 Cl. 25-01 1 Design

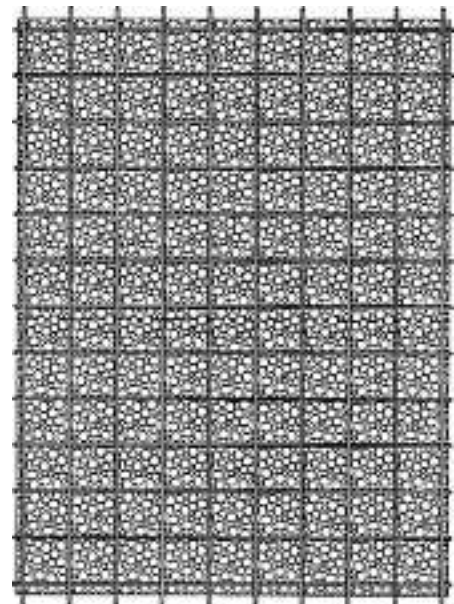
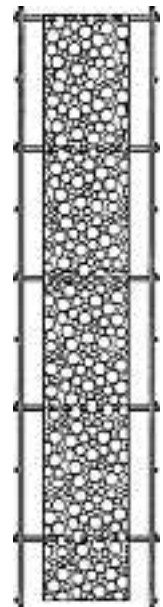
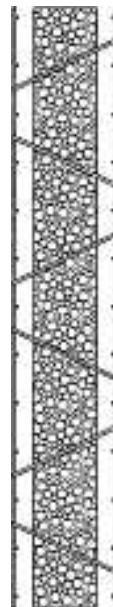
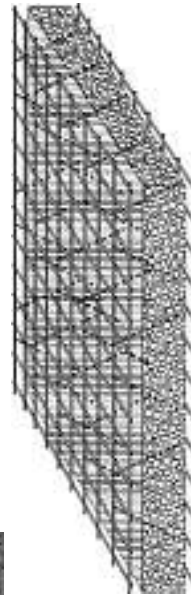

124 379	Cl.	09-03	1 Design
124 381	Cl.	09-08	1 Design
124 390	Cl.	19-08	1 design
124 404	Cl.	28-03	2 Design
124 405	Cl.	28-03	2 Design
124 450	Cl.	07-02	4 Design
124 466	Cl.	14-99	1 Design
124 467	Cl.	14-99	1 Design
124 481	Cl.	26-05	1 Design
124 498	Cl.	14-02	1 Design
124 499	Cl.	14-02	1 Design
124 501	Cl.	14-02	2 Design
124 648	Cl.	11-03	1 Design
124 712	Cl.	09-01	2 Design
128 989	Cl.	26-04	1 Design
129 008	Cl.	14-02	4 Design
129 009	Cl.	14-02	4 Design
129 010	Cl.	14-02	4 Design
129 039	Cl.	20-03	4 Design
129 048	Cl.	09-05	1 Design
129 051	Cl.	14-02	1 Design
129 057	Cl.	22-01	9 design
129 070	Cl.	07-02	5 Design
129 083	Cl.	24-02	10 Design
129 154	Cl.	14-02	1 Design
129 155	Cl.	14-02	1 Design
129 199	Cl.	10-01	1 design
129 279	Cl.	07-01	2 Design
129 319	Cl.	09-05	2 Design

Mutationen Modifications Modificazioni

116 554

120 689

121 194

121 922

122 301

122 469

122 775

123 465

124 308

124 670

124 842

125 254

125 923

126 548

126 759

127 303

127 415

128 011

128 065

128 115

128 117

128 129

128 154

128 385

128 386

128 387

128 461

128 531

128 532

128 587

128 743

128 921

128 944

129 086

129 170

129 224

129 238

129 267

129 439

129 519

129 667

130 172

130 400

130 569

130 594

130 682

130 766

130 857

131 027

131 092

131 105

131 146

131 273

131 306

131 312

Vertreter Firmaänderung

Vertreter: Schneider Feldmann AG, Patent- und
Markenanwälte, 8022 Zürich

121 964

126 103

132 305

Neuer Vertreter

Vertreter: Rentsch & Partner, 8022 Zürich

127 147

Vertreter Firmaänderung

Vertreter: Staiger, Schwald & Partner AG, 3000 Bern 6

129 008

129 009

129 010

Namensänderung

Hinterleger: Apple Inc., 1, Infinite Loop, Cupertino, CA 95014,
US

129 214

Neuer Vertreter
Vertreter: Patentanwaltsbureau Jean Hunziker AG,
8126 Zumikon

129 738**129 895****130 669**

Vertreter Firmaänderung
Vertreter: Schneider Feldmann Patent- und Markenanwälte AG,
8022 Zürich

130 909**130 926****132 719**

Vertreter Firmaänderung
Vertreter: Staiger, Schwald & Partner AG, 8027 Zürich

131 419

Nouveau mandataire
Mandataire: BLUM Rechtsanwälte, 8021 Zürich

Löschungen Radiations Radiazioni

119 473	Cl.	07-02	4	Design
119 475	Cl.	09-03	2	Design
119 555	Cl.	23-02	11	Design
119 556	Cl.	23-02	13	Design
119 586	Cl.	18-01	1	Design
119 587	Cl.	18-02	1	Design
123 894	Cl.	06-04	2	Design
123 908	Cl.	12-13	1	Design
123 914	Cl.	14-01	1	Design
123 915	Cl.	14-03	1	Design
123 930	Cl.	06-03	1	Design
124 006	Cl.	07-01	1	Design
124 007	Cl.	07-01	1	Design
124 008	Cl.	07-01	1	Design
128 511	Cl.	20-03	163	design
128 520	Cl.	06-01	2	Design
128 521	Cl.	06-03	3	Design
128 522	Cl.	06-06	1	Design
128 523	Cl.	06-06	1	Design
128 524	Cl.	06-13	1	Design
128 525	Cl.	06-13	1	Design
128 526	Cl.	07-01	2	Design
128 527	Cl.	07-01	2	Design
128 528	Cl.	07-01	1	design
128 530	Cl.	07-01	1	Design
128 539	Cl.	10-02	1	design
128 540	Cl.	10-02	1	design
128 541	Cl.	10-02	2	design
128 542	Cl.	10-02	2	design
128 543	Cl.	10-02	1	design
128 545	Cl.	10-07	7	design
128 546	Cl.	11-01	2	Design
128 547	Cl.	11-01	22	design
128 550	Cl.	14-03	375	Design
128 552	Cl.	15-05	1	Design
128 553	Cl.	15-05	1	Design
128 554	Cl.	15-05	1	Design
128 556	Cl.	19-02	1	Design
128 561	Cl.	26-05	5	Design
128 563	Cl.	02-04	3	Design
128 566	Cl.	04-02	1	Design
128 618	Cl.	07-07	3	Design
128 624	Cl.	10-07	1	Design