

## Nationale Hinterlegungen

In der folgenden Liste werden die beim Eidgenössischen Institut für Geistiges Eigentum hinterlegten Designs publiziert. Dabei sind der Reihe nach angegeben:

- internationale Klassenangaben
- Hinterlegungsnummer
- Hinterlegungsdatum
- Allenfalls Aufschub der Veröffentlichung
- Anzahl der hinterlegten Designs
- Bezeichnung
- Name und Wohnsitz des Hinterlegers oder der Hinterlegerin
- gegebenenfalls Name und Wohnsitz des Designers oder der Designerin
- Name und Geschäftssitz des allfälligen Vertreters oder der Vertreterin
- gegebenenfalls Prioritätsangaben
- gegebenenfalls Beschreibungstext
- Ordnungsnummer
- Reproduktion des Designs

## Internationale Hinterlegungen

Die bei der Weltorganisation für geistiges Eigentum in Genf hinterlegten Muster und Modelle mit Benennung Schweiz geniessen den gleichen Schutz wie national hinterlegte Designs. Sie werden jeweils im Blatt «Bulletin des dessins et modèles internationaux» veröffentlicht. Dieses Publikationsorgan ist deshalb für eine vollständige Recherche unbedingt beizuziehen.

## Topographien

Angaben über die vom Eidgenössischen Institut für Geistiges Eigentum eingetragenen Topographien von Halbleitererzeugnissen werden in folgender Anordnung aufgeführt:

- Eintragsnummer
- Anmeldedatum
- Bezeichnung
- Name und Wohnsitz des Anmelders oder der Anmelderin
- gegebenenfalls Name und Wohnsitz des Herstellers oder der Herstellerin
- Name und Geschäftssitz des oder der allfälligen Bevollmächtigten
- Datum und Ort einer allfälligen ersten geschäftlichen Verbreitung der Topographie

## Dépôts nationaux

Les designs déposés à l'Institut Fédéral de la Propriété Intellectuelle sont publiés dans la liste qui suit. Les indications y relatives sont mentionnées dans cet ordre:

- indications des classes internationales
- numéro de dépôt
- date de dépôt
- le cas échéant, ajournement de la publication
- nombre des designs déposés
- désignation
- nom et domicile du/de la déposant/e
- le cas échéant, nom et domicile du/de la designer
- nom et domicile de l'éventuel/le mandataire
- le cas échéant, indication de priorité
- le cas échéant, description du design
- numéro attribué à chaque design
- reproduction du design

## Dépôts internationaux

Les dessins et modèles déposés à l'Organisation Mondiale de la Propriété Intellectuelle à Genève qui désignent la Suisse jouissent de la même protection que les dépôts nationaux. Ils sont chaque fois publiés dans la feuille «Bulletin des dessins et modèles internationaux». Pour une recherche complète, il est indispensable de consulter ledit organe de publication.

## Topographies

Les indications concernant les topographies des produits semi-conducteurs, enregistrées par l'Institut Fédéral de la Propriété Intellectuelle, sont énumérées dans l'ordre suivant:

- numéro d'enregistrement
- date de dépôt
- désignation
- nom et domicile du/de la déposant/e
- le cas échéant, nom et domicile du/de la producteur/trice
- nom et domicile de l'éventuel/le mandataire
- date et lieu d'une éventuelle première mise en circulation de la topographie

## Depositi nazionali

Nella lista seguente vengono pubblicati i design depositati presso l'Istituto Federale della Proprietà Intellettuale. Sono menzionati nel seguente ordine:

- indicazioni delle classi internazionali
- numero di deposito
- data del deposito
- se del caso, indicazione che la pubblicazione è stata differita
- numero dei design depositati
- designazione
- nome e domicilio del depositante
- se del caso, nome e domicilio del designer
- nome e sede di un eventuale mandataro
- se del caso, indicazioni di priorità
- se del caso, descrizione del design
- numero d'ordine
- riproduzione del design

## Depositi internazionali

I disegni e modelli depositati presso l'Organizzazione Mondiale della Proprietà Intellettuale a Ginevra con denominazione Svizzera godono della medesima protezione del deposito nazionale. Essi vengono pubblicati ogni volta nel foglio «Bulletin des dessins et modèles internationaux». Quest'organo di pubblicazione è da consultare se si vuole effettuare una ricerca completa.

## Topografie

Le indicazioni concernenti le topografie di prodotti a semiconduttori depositati presso l'Istituto Federale della Proprietà Intellettuale sono menzionate nell'ordine seguente:

- numero di registrazione
- data del deposito
- designazione
- nome e domicilio del/la richiedente
- se del caso, nome e domicilio del/la produttore/trice
- nome e sede di un eventuale mandataro
- data e luogo di un'eventuale prima messa in circolazione della topografia

## Hinterlegungen

### Dépôts

### Depositi

Cl. 24-02 131 147 03.11.2004  
 1 Design – Mikrotiterplatte  
 Hinterleger: F. Hoffmann-La Roche AG, Grenzacherstrasse 124,  
 4070 Basel  
 Designer: Peter Berndt, Basel; Christof Fattinger, Blauen;  
 Remo Anton Hochstrasser, Oberwil; Tom Kissling, Riehen  
 Vertreter: Ventocilla Patent AG, 4107 Ettingen  
 Ende aufgeschobene Publikation

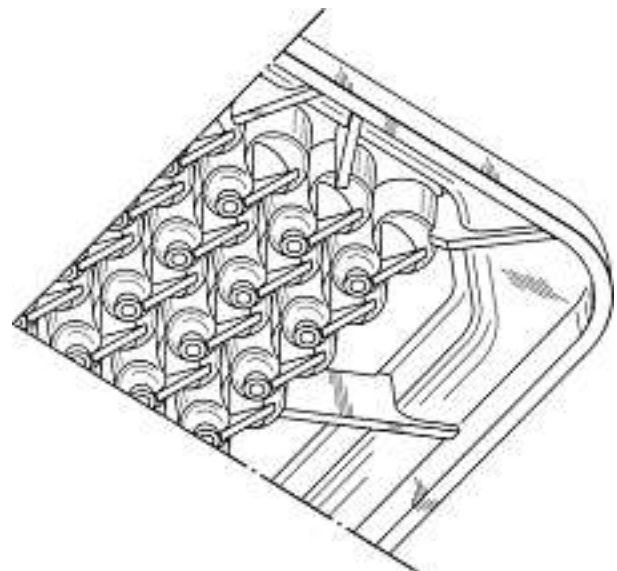
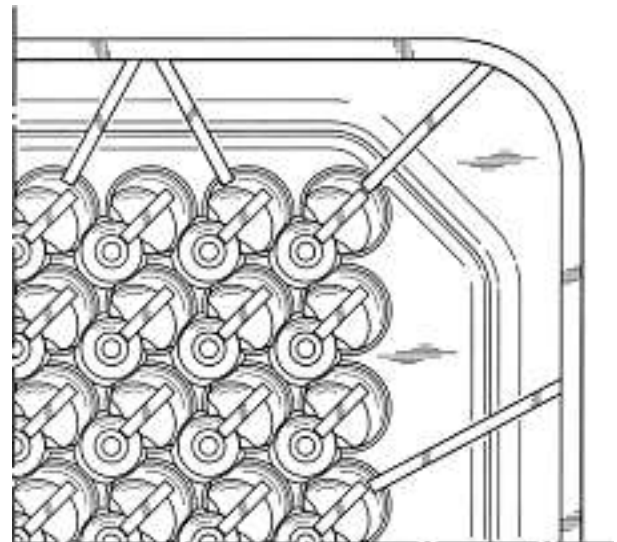
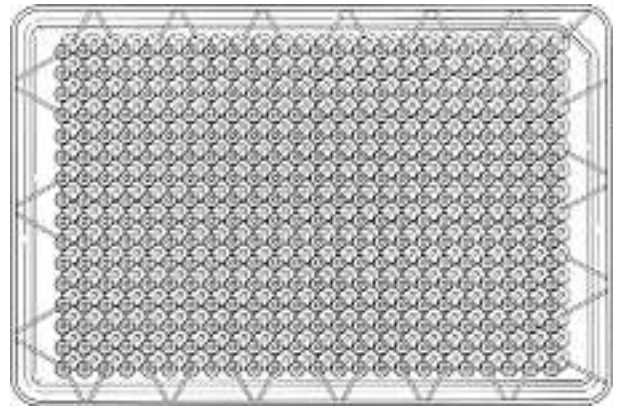
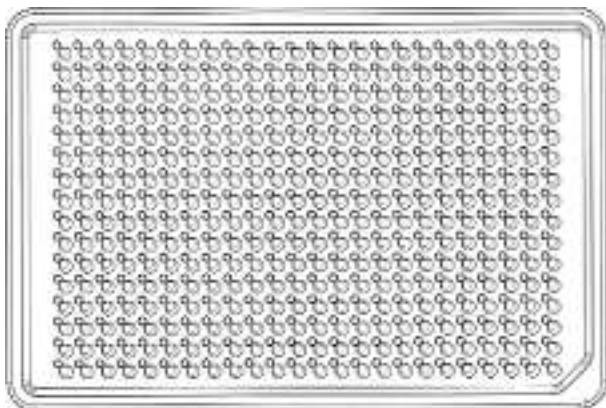

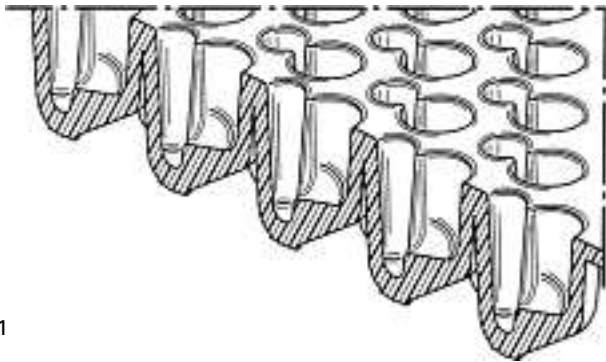
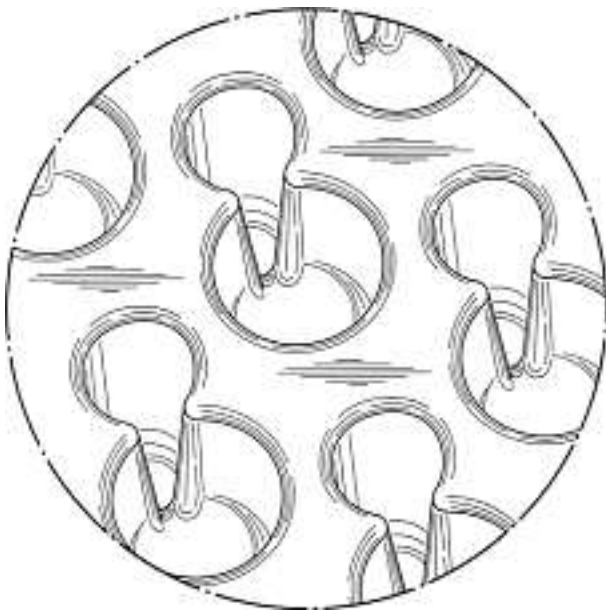

1

Cl. 21-02 132 100 23.08.2005

1 design – appareil d'exercices pour les bras  
 Déposant: Productions Imagine Enterprise Inc., 353,  
 2ième Avenue, apt. 1, Ville de l'Île Perrot (Québec), CA  
 Designer: Pierre Paul Beaupré, Ville de l'Île Perrot  
 Mandataire: Micheli & Cie, 1226 Thônex (Genève)  
 Priorité: CA, 25.02.2005  
 Fin de la période ajournement de la publication

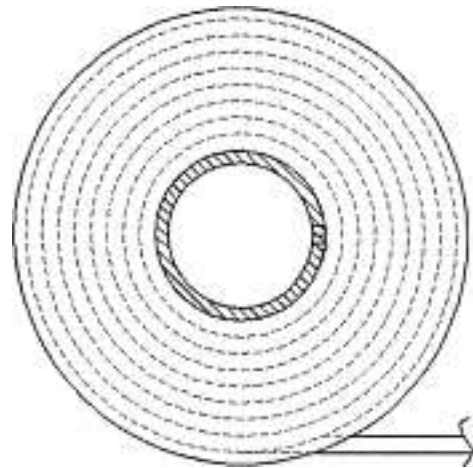
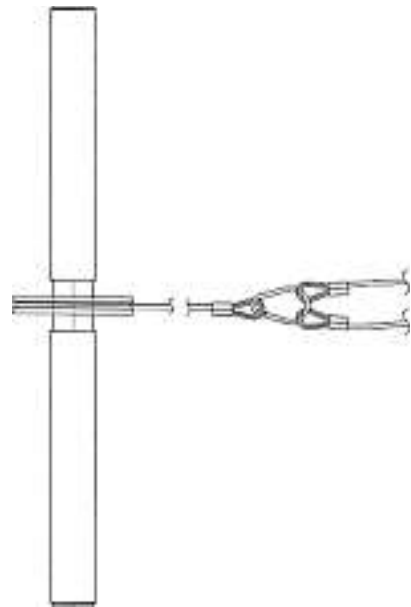
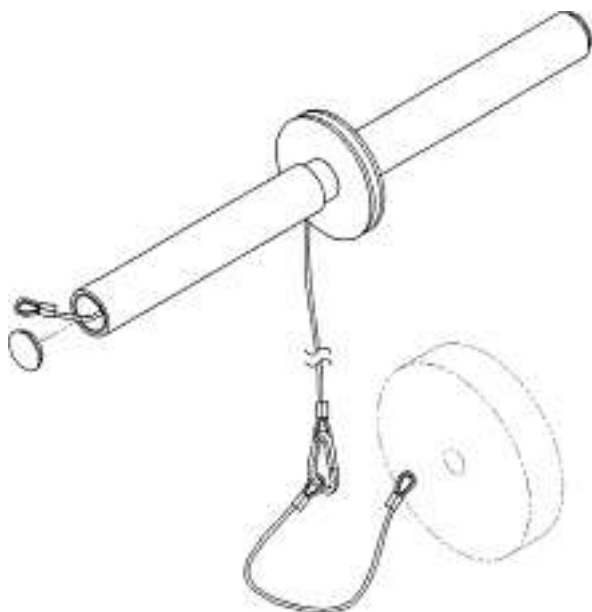

14530

Cl. 10-07 132 705 03.04.2006

3 design – boîte de montre, bracelet  
 Déposant: Richemont International S.A., Route des Biches 10,  
 1752 Villars-sur-Glâne  
 Designer: Marco Borraccino, Milan; Angelo Bonati, Sesto San  
 Giovanni  
 Mandataire: MICHELI & CIE SA, 1226 Thônex  
 Fin de la période ajournement de la publication



14686 A



14686 B



14686 C

Cl. 10-02, 10-07      **133 529**      12.01.2007  
 11 design – montres, boîtiers de montre, cadrans de montre,  
 parties de cadrans de montre, bracelet de montre, fermoirs  
 de montre, éléments décoratifs de montre  
 Déposant: de Grisogono S.A., 176bis, Route de Saint-Julien,  
 1228 Plan-les-Ouates  
 Designer: Fawaz Gruosi, Prangins  
 Fin de la période ajournement de la publication

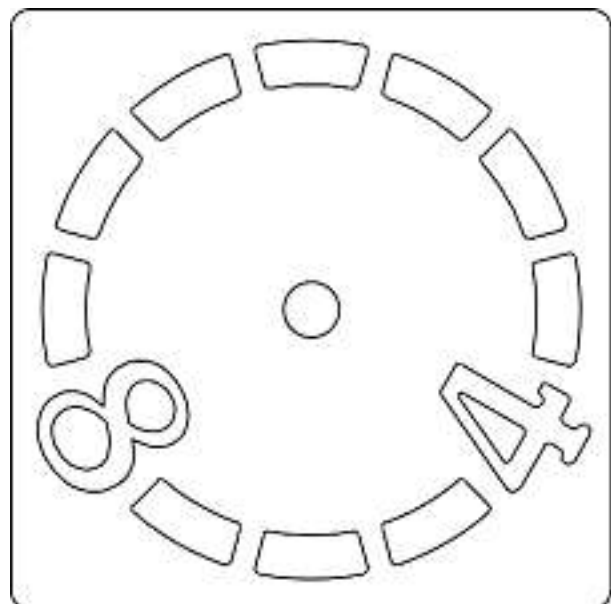

D07-CH-M-1

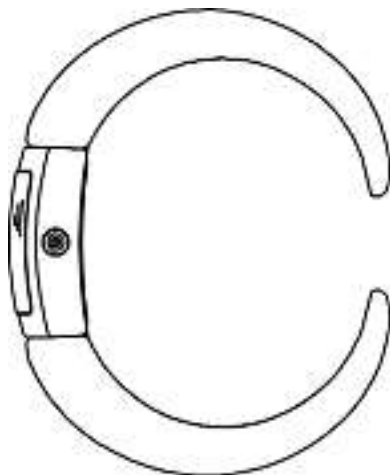
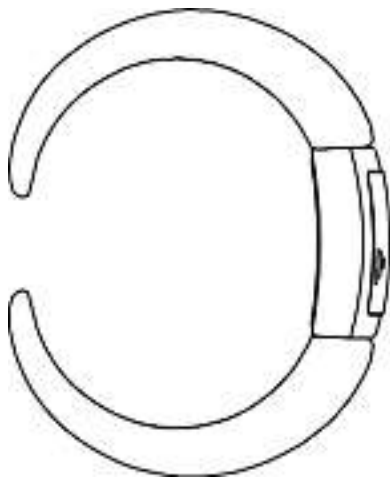
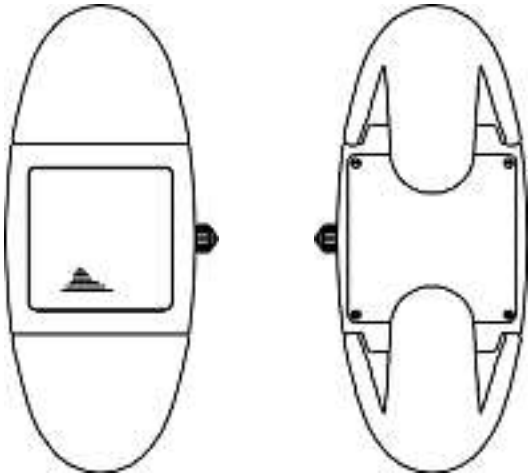
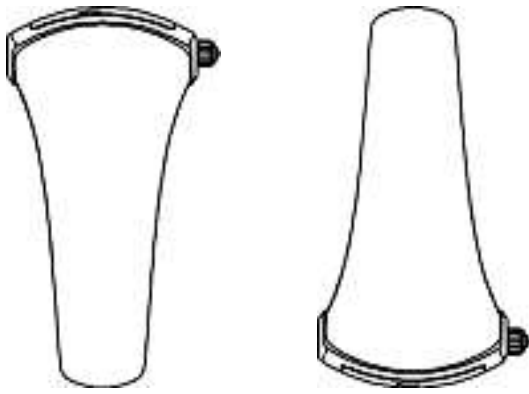

D07-CH-M-2

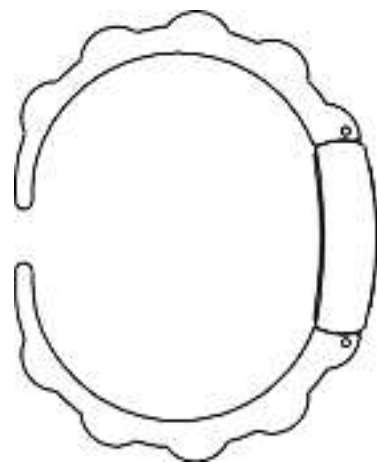
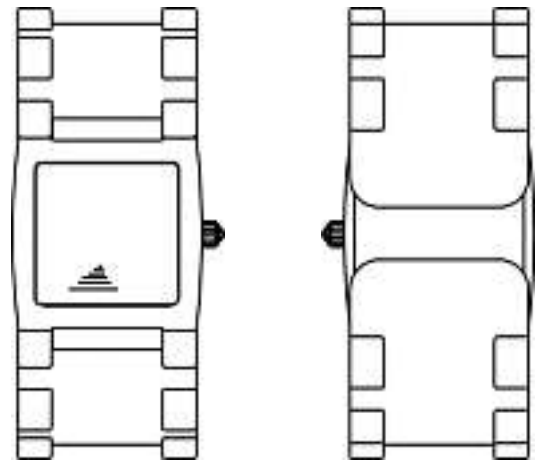
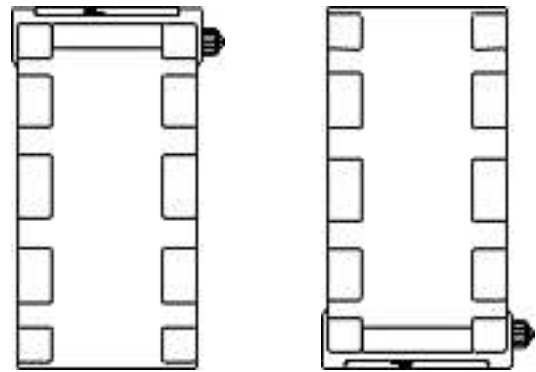

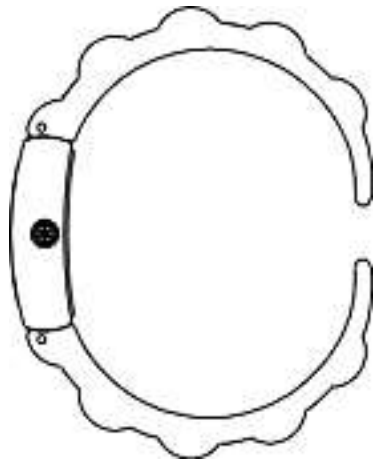

D07-CH-M-3

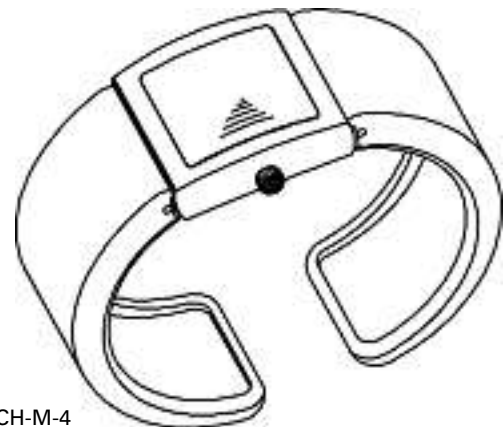
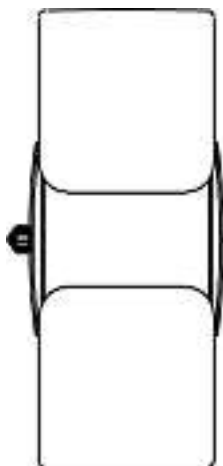
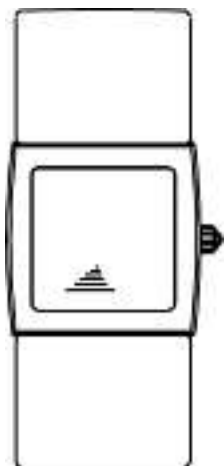

D07-CH-M-4

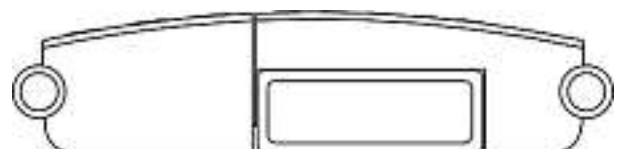
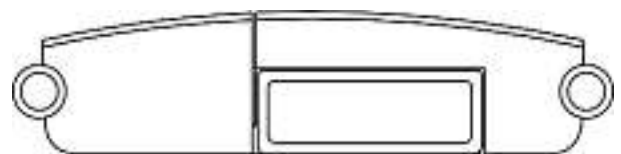

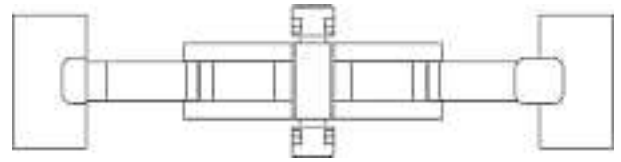
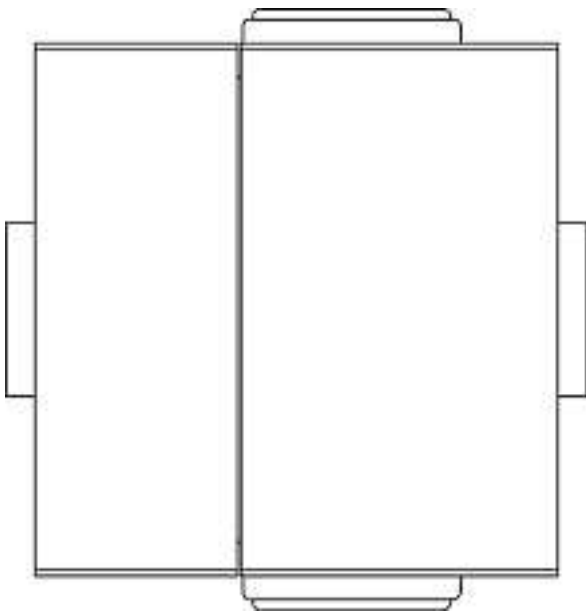

D07-CH-M-6

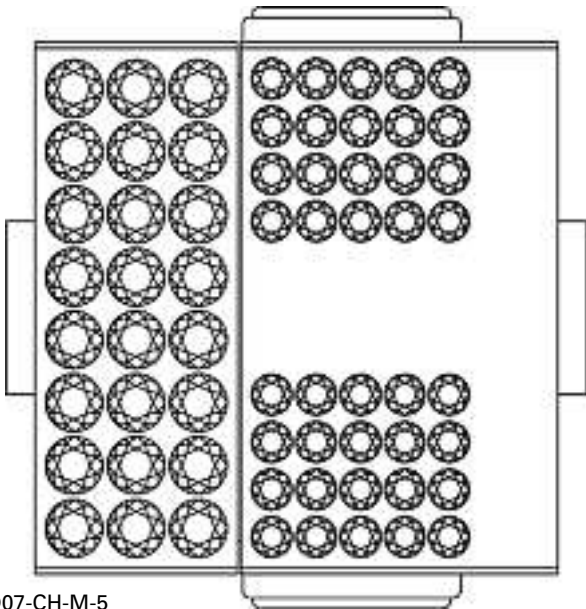

D07-CH-M-5

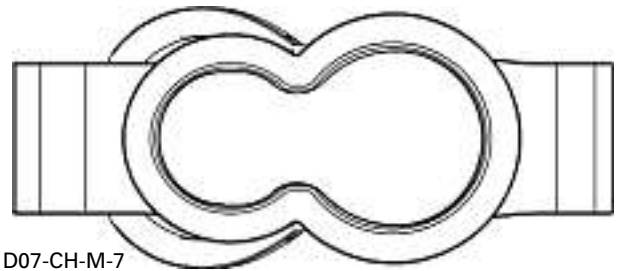
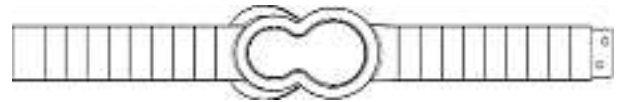

D07-CH-M-7

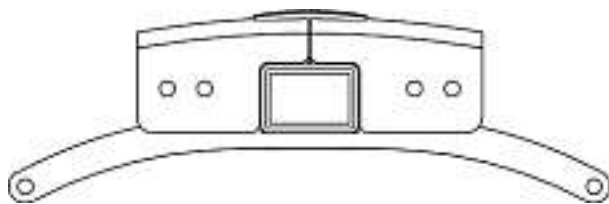

D07-CH-M-5bis

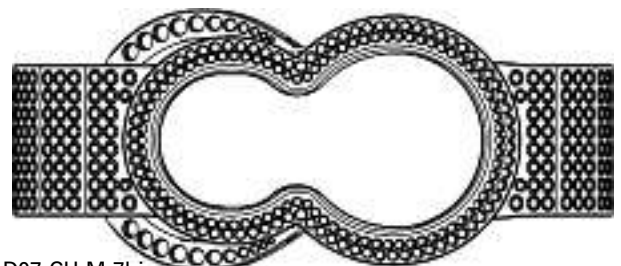
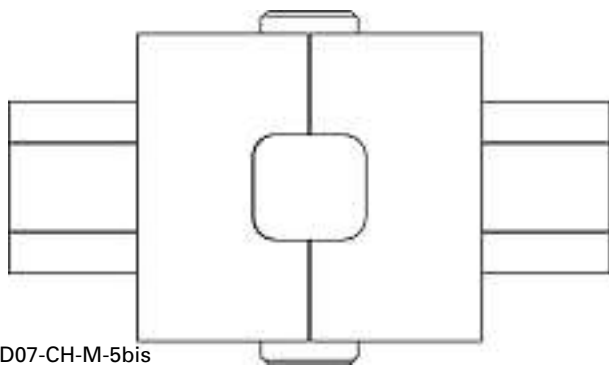

D07-CH-M-7bis

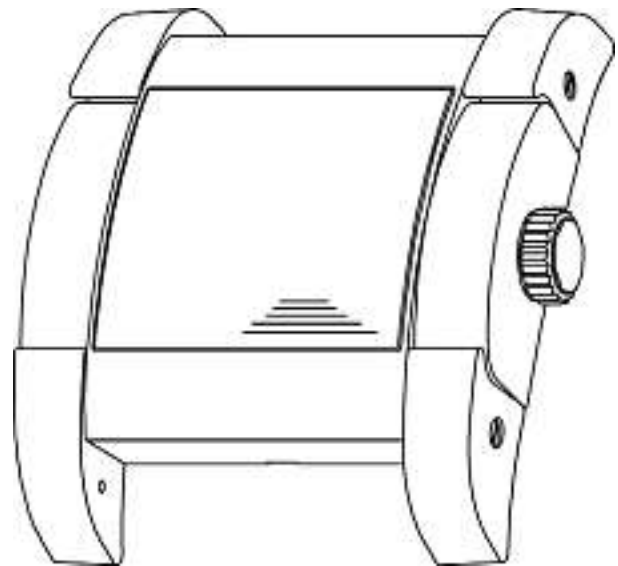
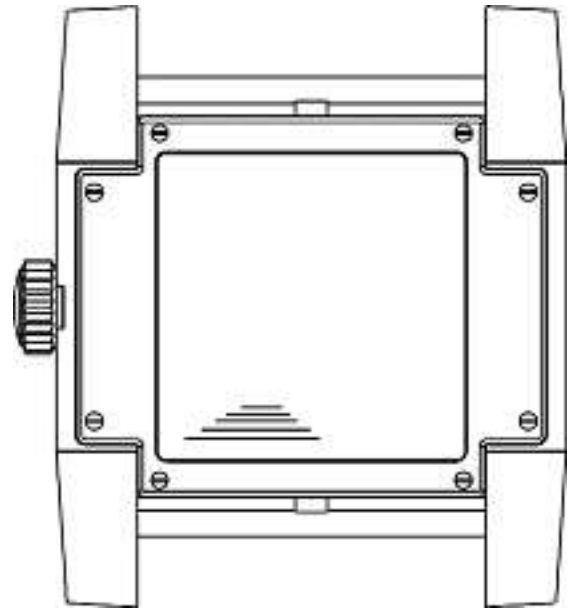
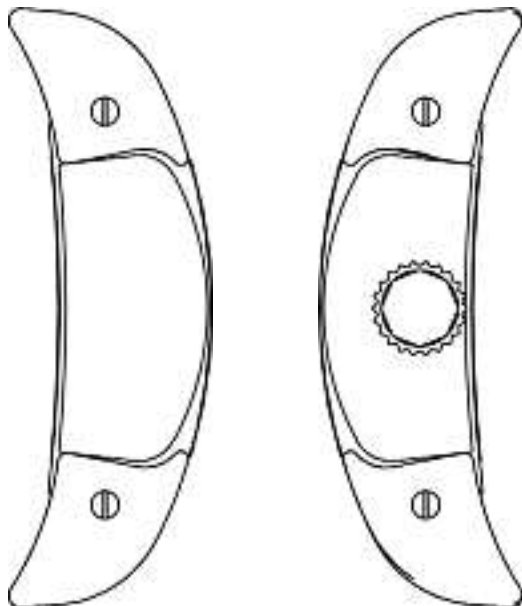
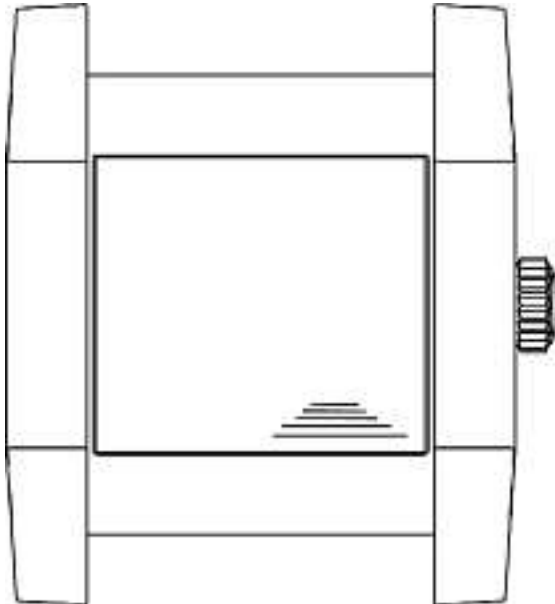
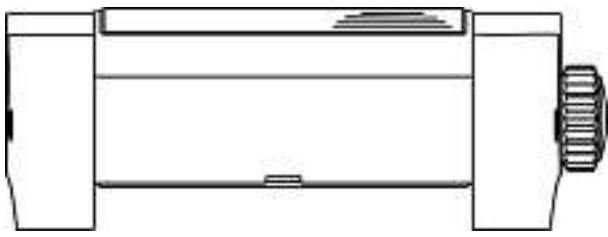

D07-CH-M-8

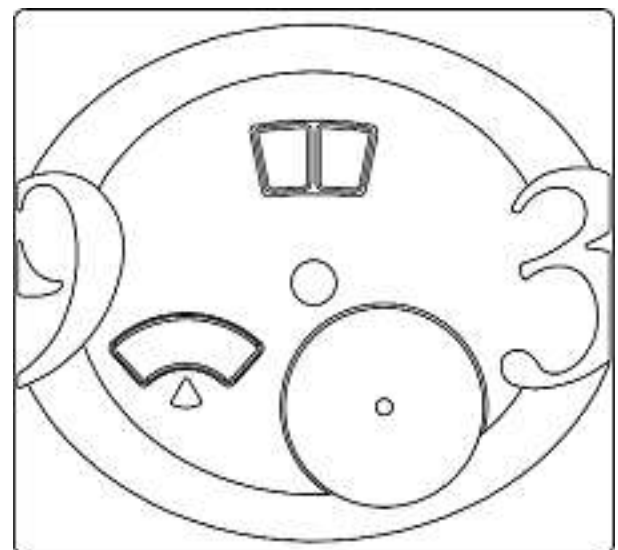

D07-CH-M-9



Cl. 02-04 133 743 08.01.2007  
 30 Design – Schuhe  
 Hinterleger: Crocs, Inc., 6328 Monarch Park Place, Niwot, CO, US  
 Designer: Stefano del Biondi, Noventa Padovana; Ilenia Riccoboni, Camponogara; Lucio Stefanello, Mestre; Marta Cacitti, Tolmezzo  
 Vertreter: Keller & Partner Patentanwälte AG, 3000 Bern 7  
 Priorität: US, 11.07.2006; US, 15.12.2006  
 Beschreibung des Designs: Die gestrichelten Linien in den Zeichnungen zeigen Gestaltungselemente, die nicht zum Design gehören.



1



4

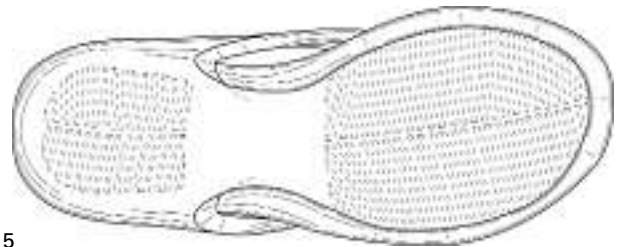
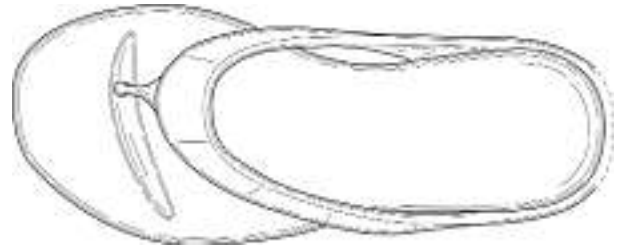
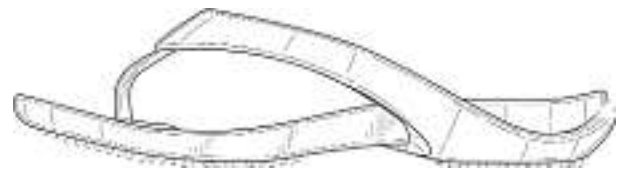
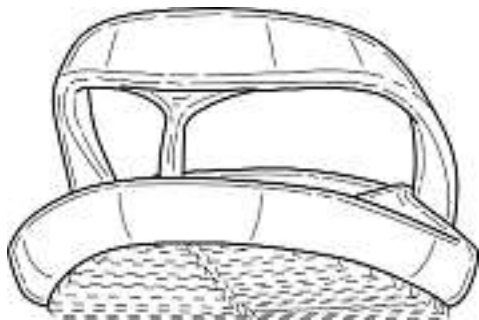
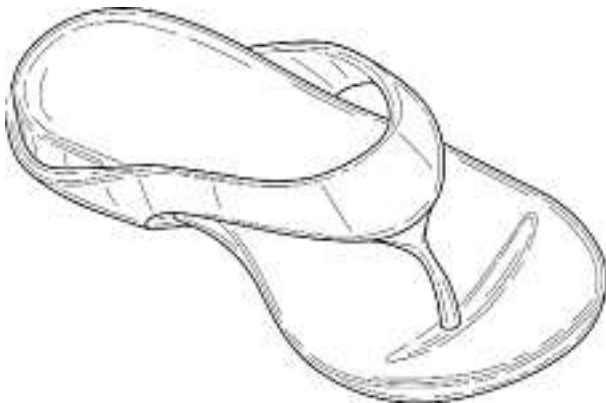

5

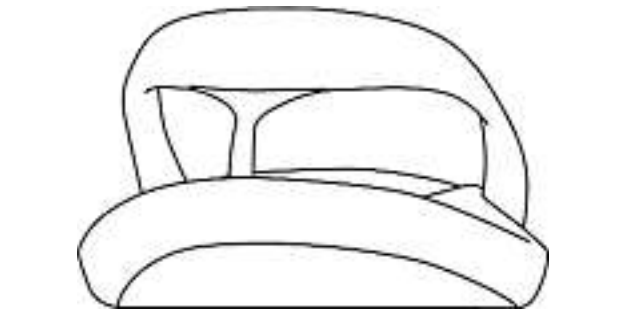
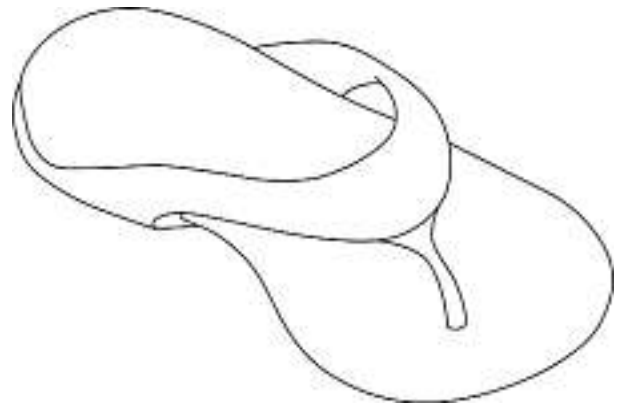

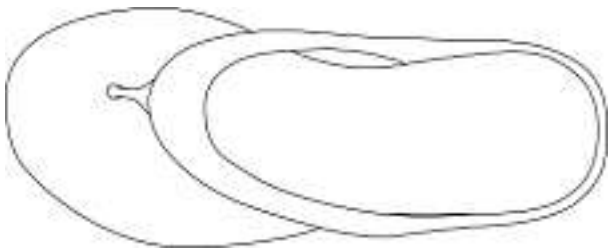
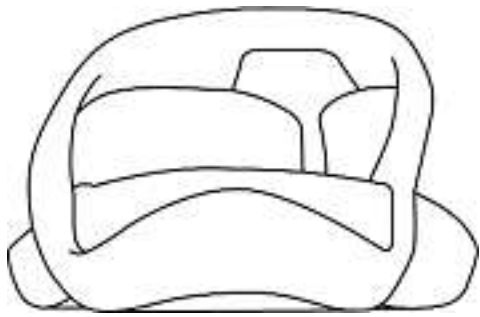

6



7

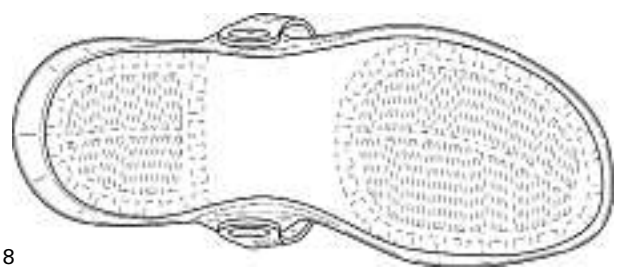
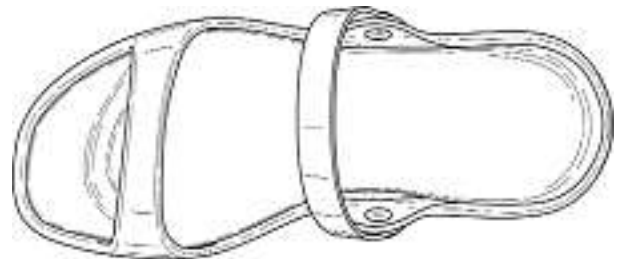
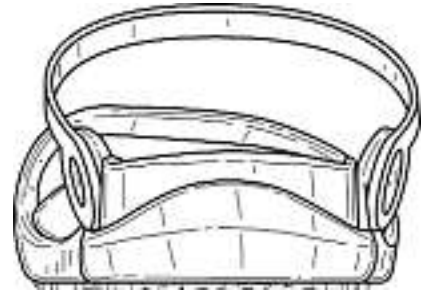
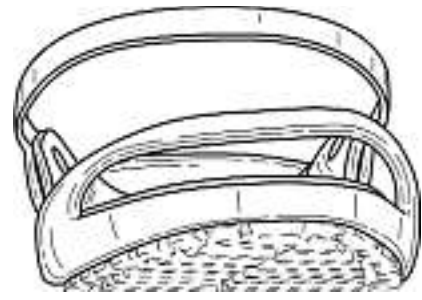

8

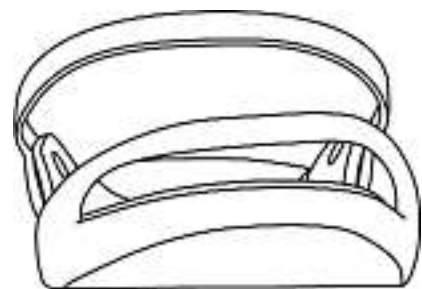

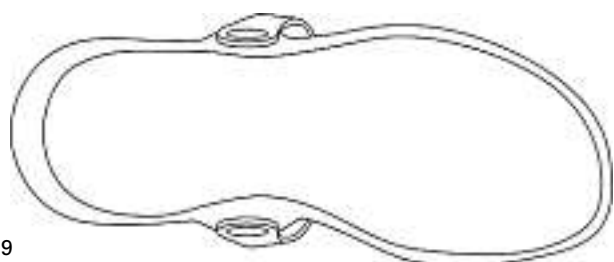
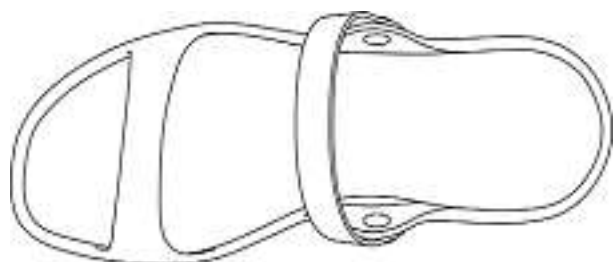
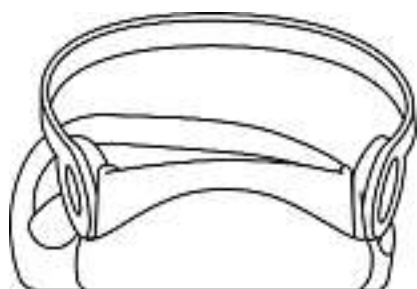

9



10



11

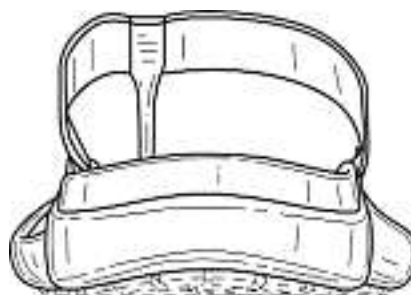
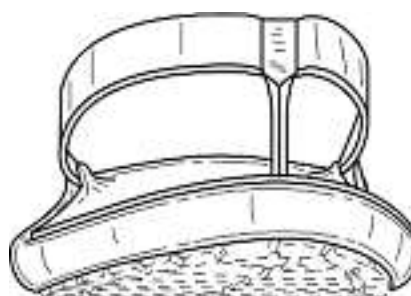
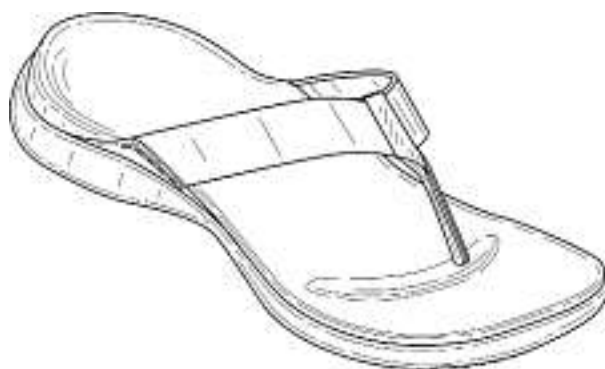

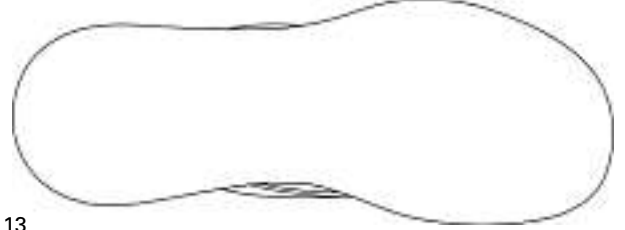
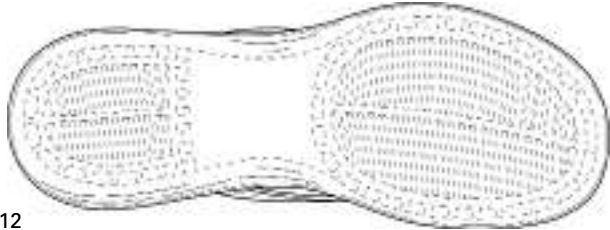
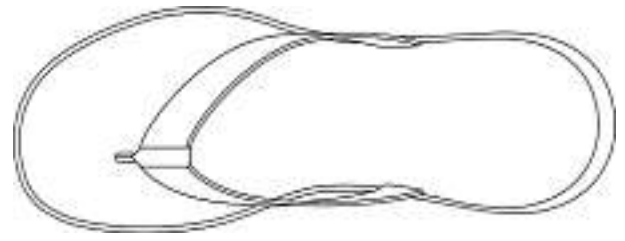
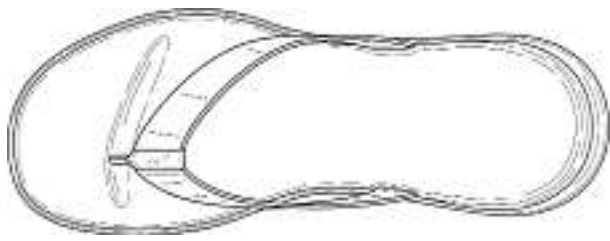

12

13



14

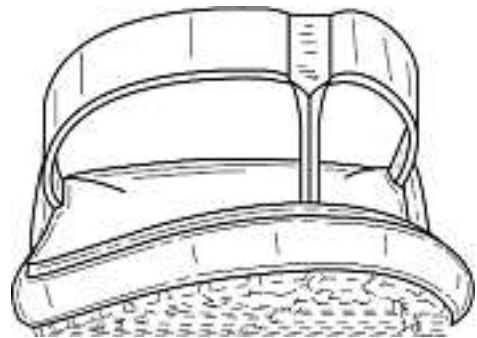
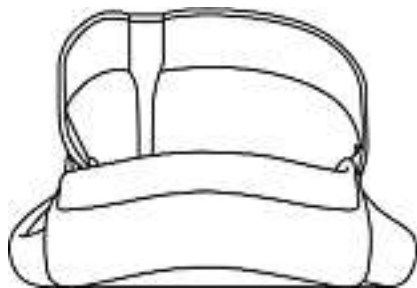
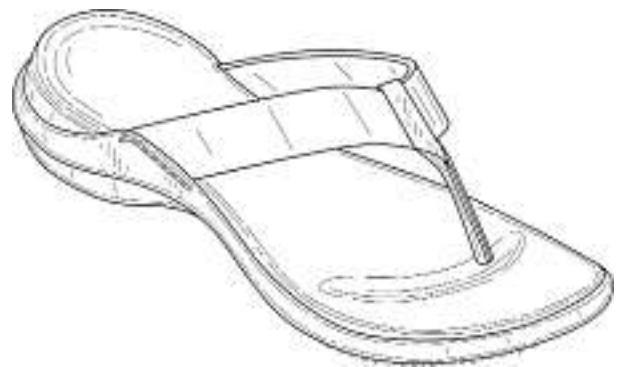
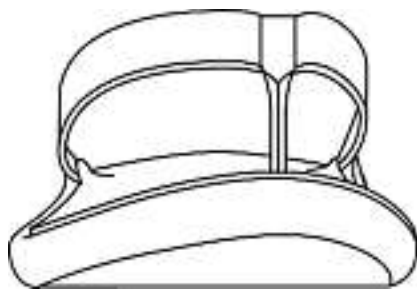

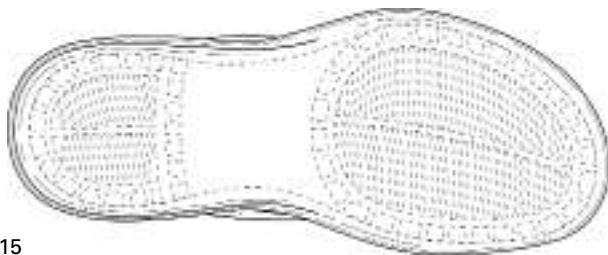
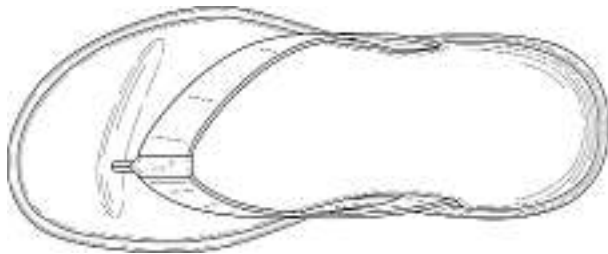

15

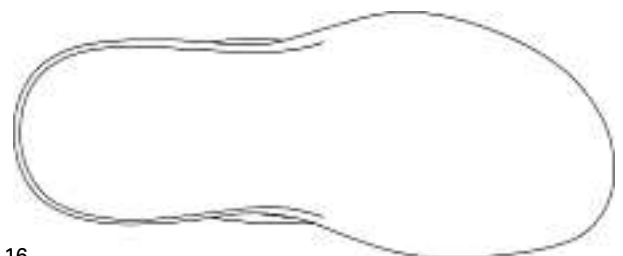
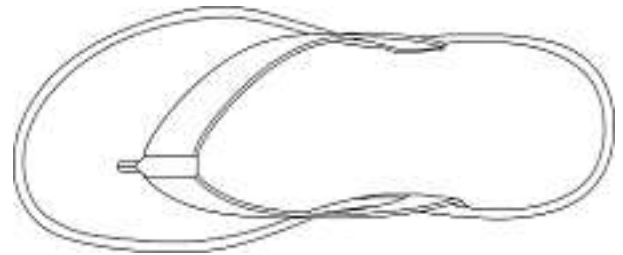
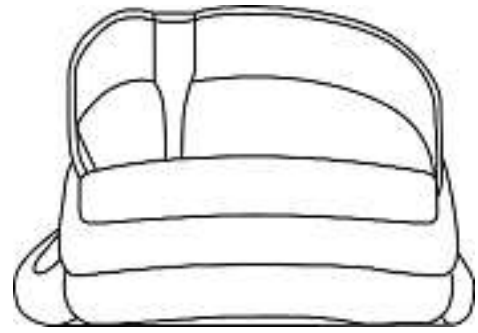
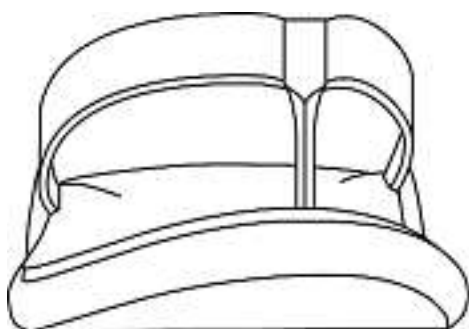
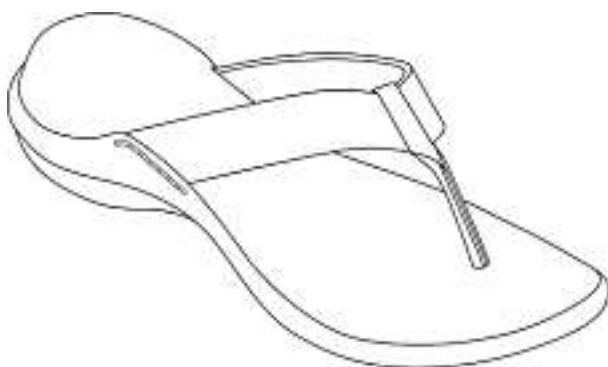

16



17



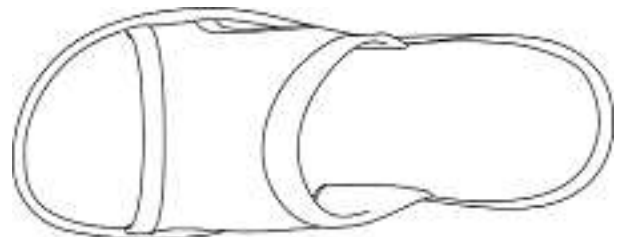
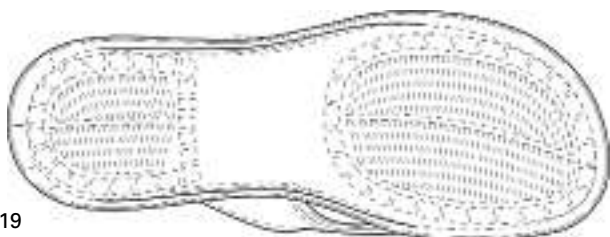
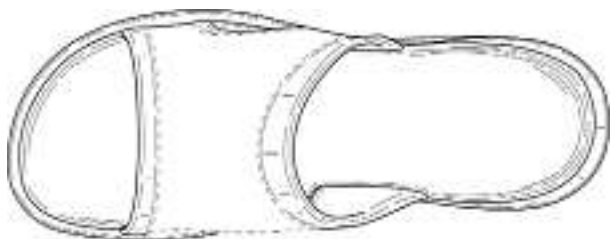
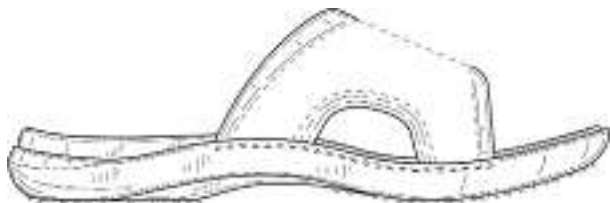
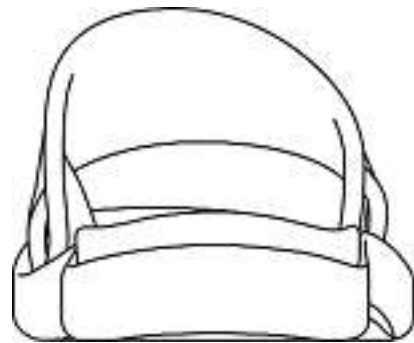
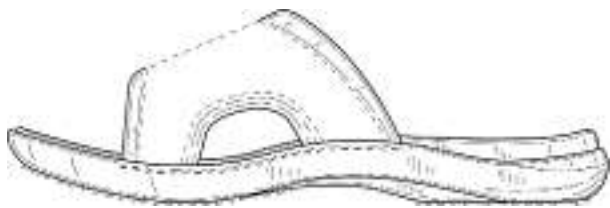
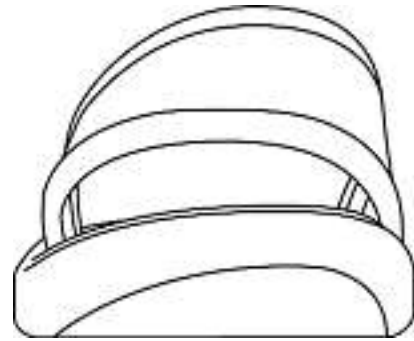
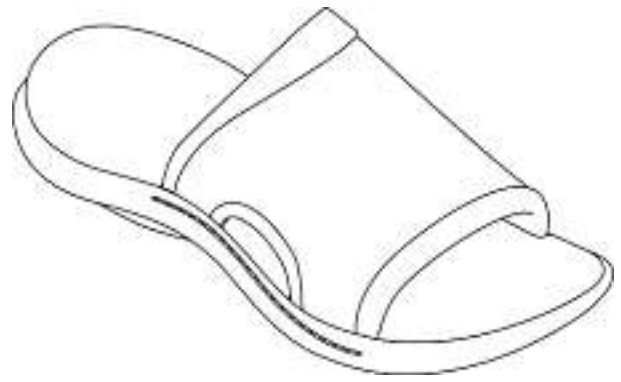
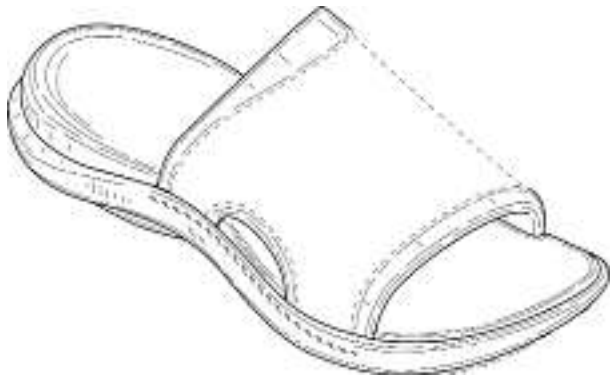

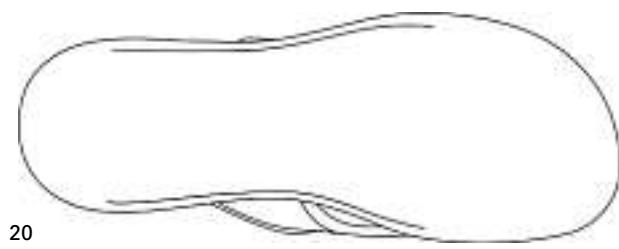

20



21

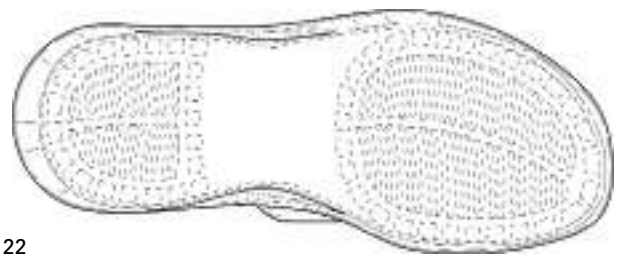
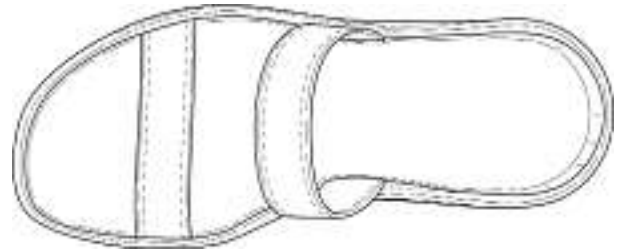
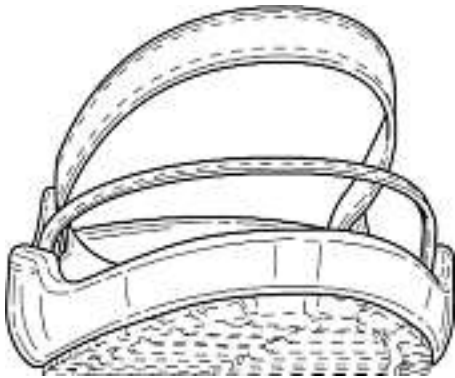
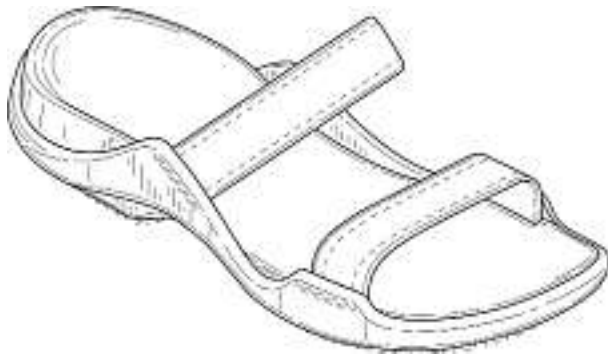

22

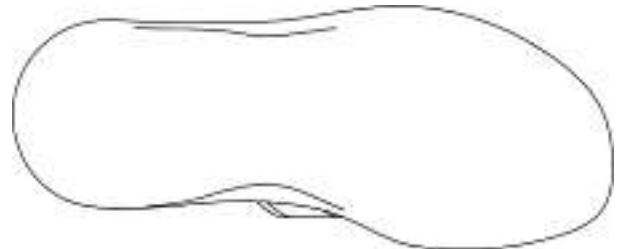
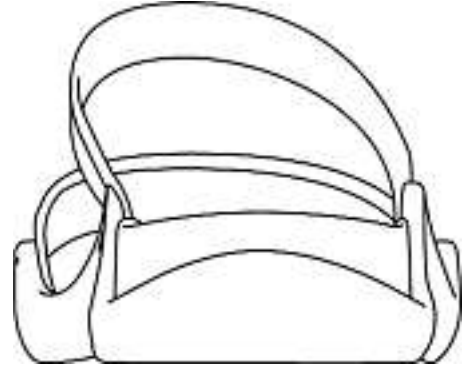
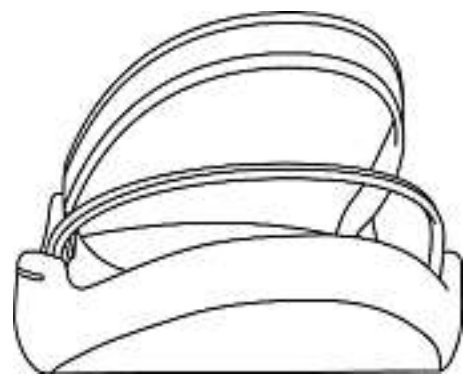



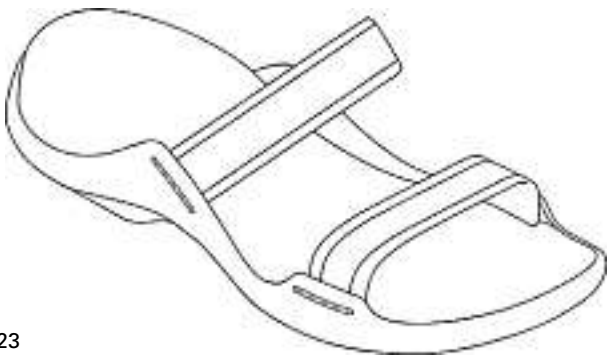
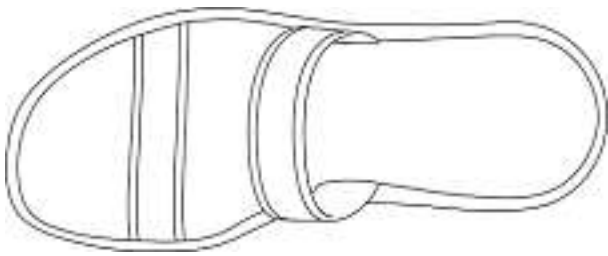

23



24



27

28

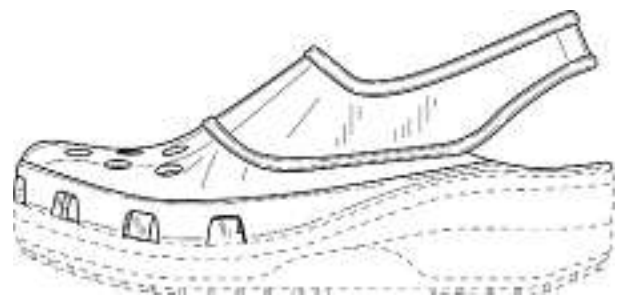
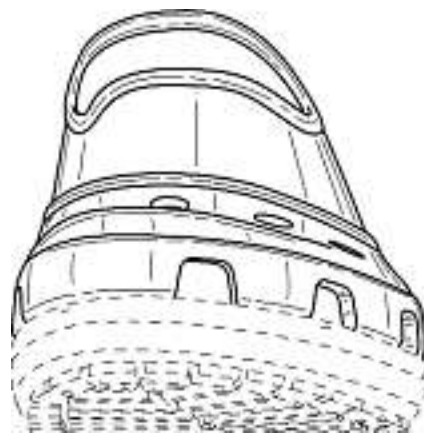
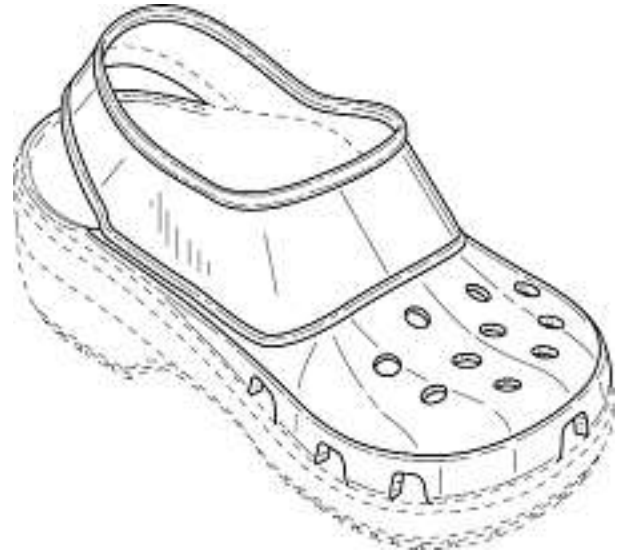



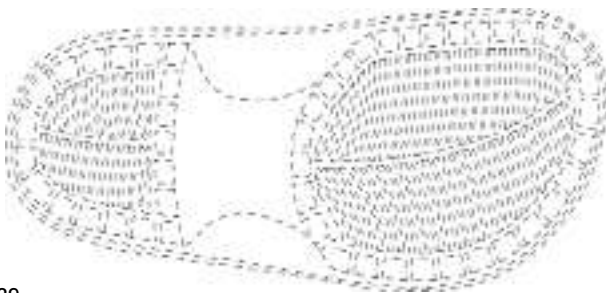
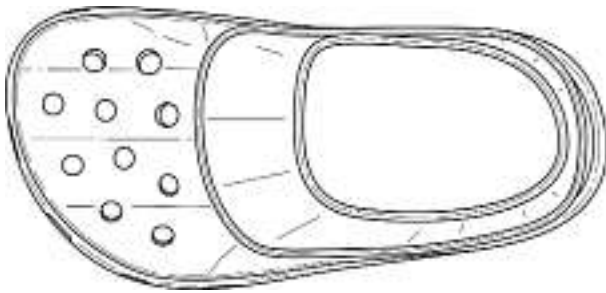
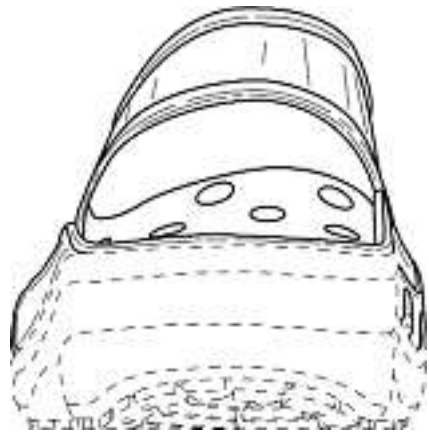

29

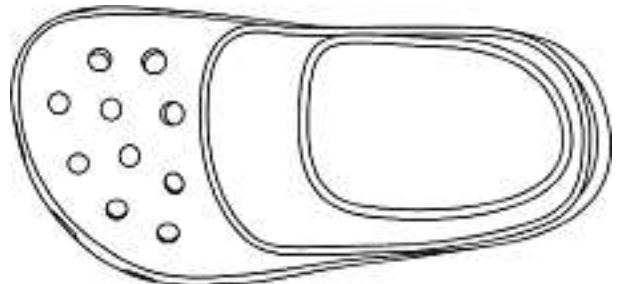
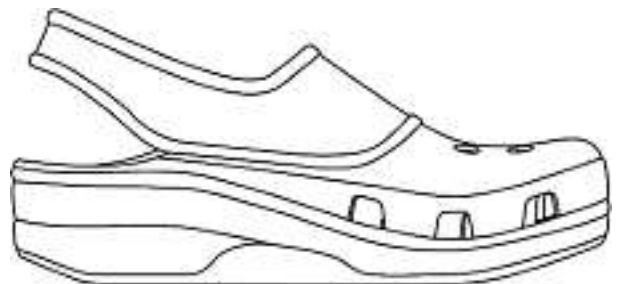
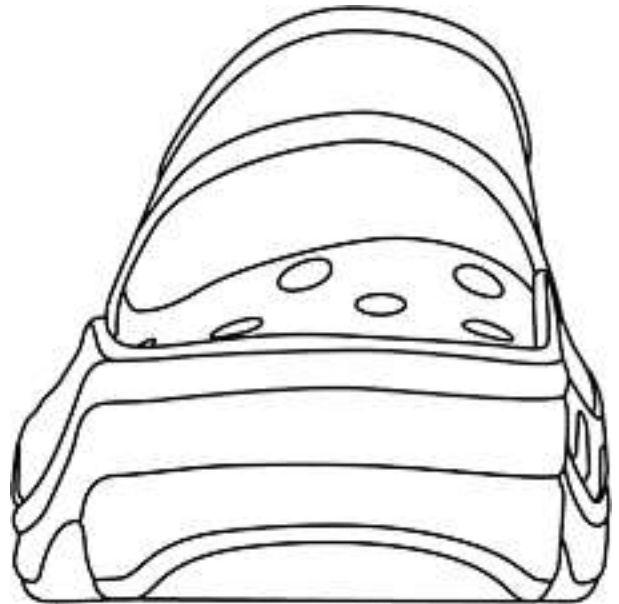
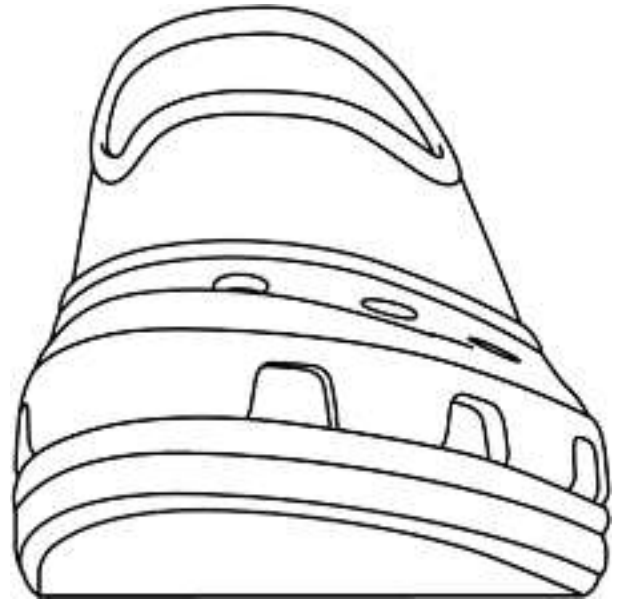
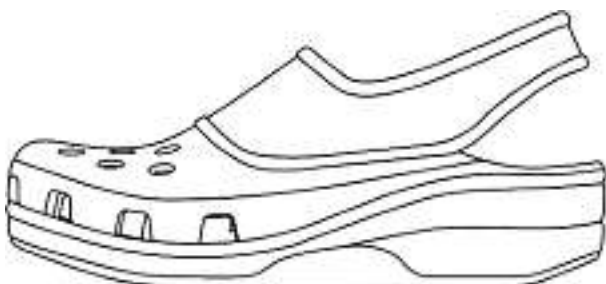

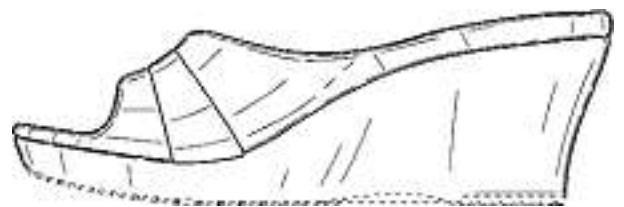
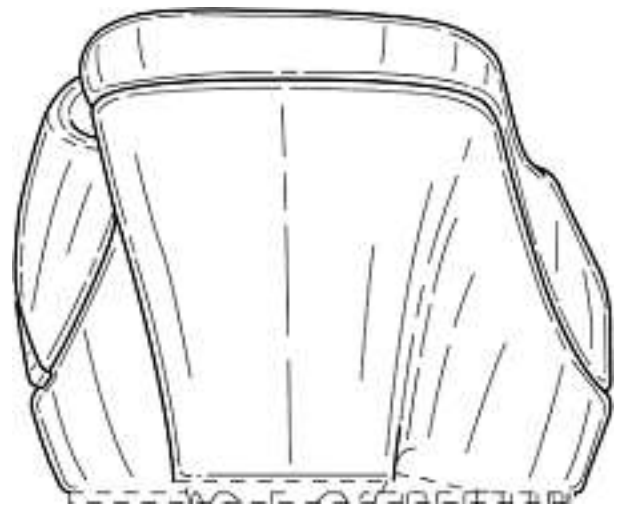
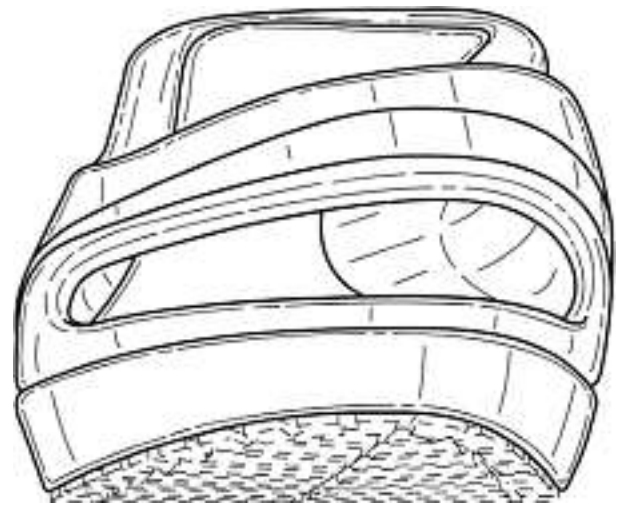
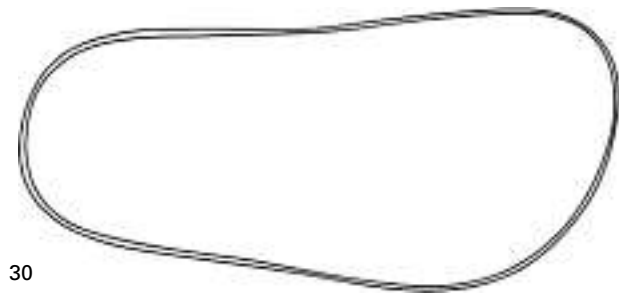

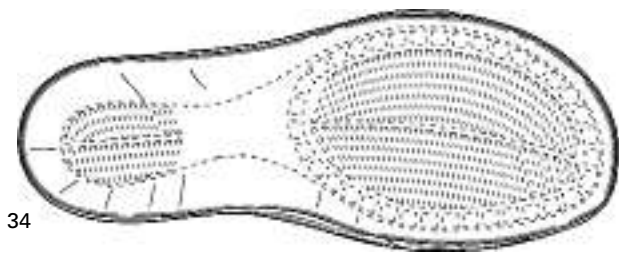

34

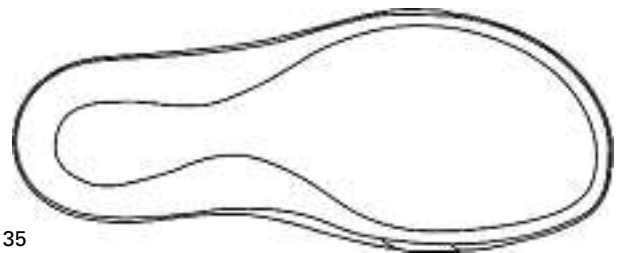
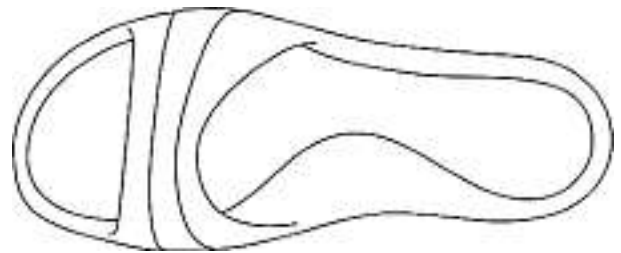
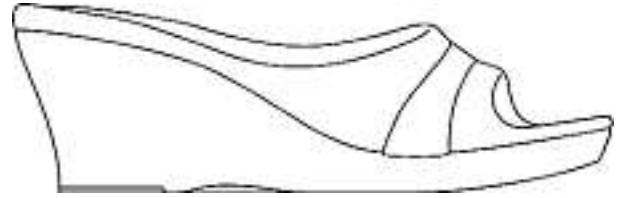
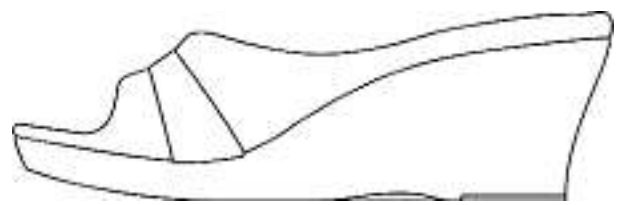
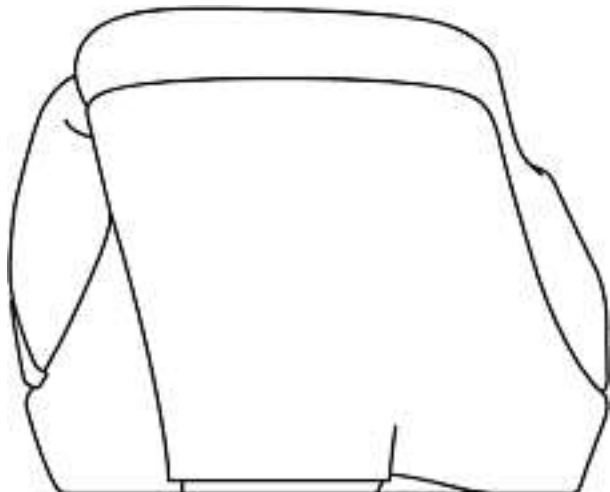
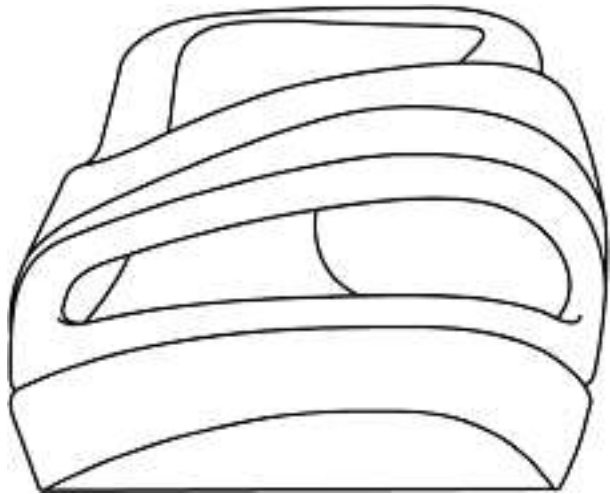

35

Cl. 03-01 133 744 19.03.2007

1 design – borsa

Depositante: Guccio Gucci S.p.A., Via Tornabuoni, 73/R, 50123 Firenze, IT

Designer: Frida Giannini, Firenze

Mandatario: Jacobacci & Partners S.A., 1207 Genève

Priorità: EM, 05.03.2007



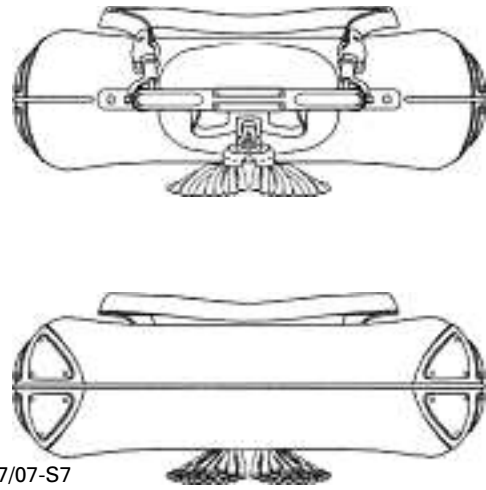

D-2047/07-S7

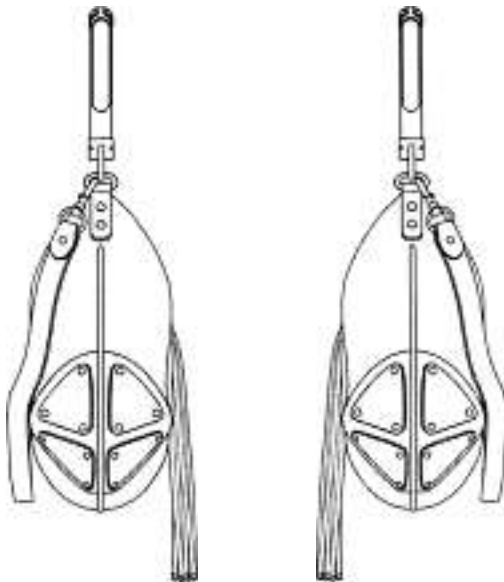

Cl. 06-01 133 745 16.01.2007

2 Design – Liegestuhl

Hinterleger: Glas Trösch AG Steffisburg, Bernstrasse 120,  
3613 Steffisburg

Designer: Martin Zbären, Frutigen

Vertreter: Keller & Partner Patentanwälte AG, 3000 Bern 7



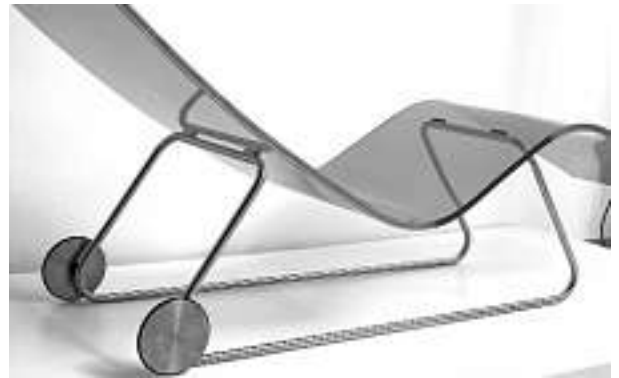
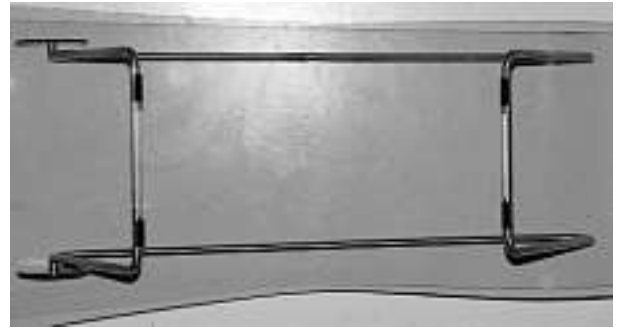

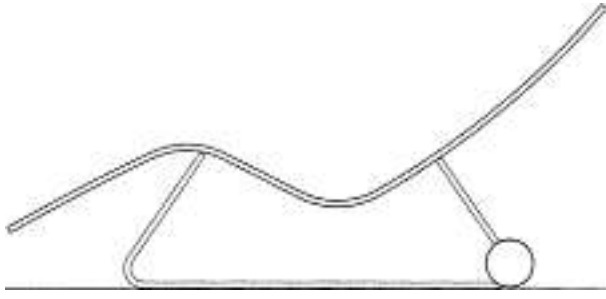
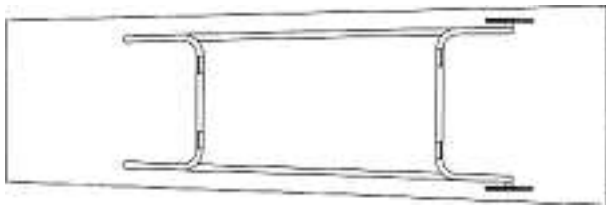

1

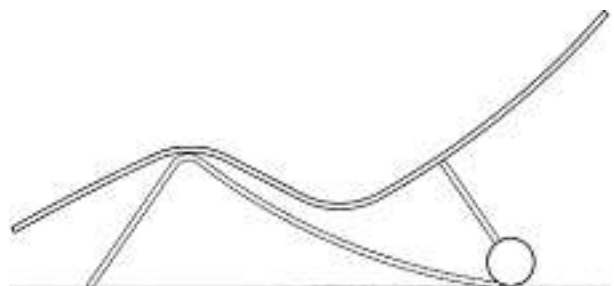

2

Cl. 06-01 **133 746** 21.03.2007

1 Design – Liegestuhl

Hinterleger: Gabriel Kostner, Str. Dantercepies 18,  
39048 Selva di Val Gardena, Wolkenstein (BZ), IT  
Vertreter: A. Braun, Braun, Héritier, Eschmann AG,  
Patentanwälte, 4051 Basel  
D353363CH00 (Farbteil siehe Heftmitte)

Cl. 06-03 **133 747** 28.02.2007

2 Design – Tisch

Hinterleger: Knürr AG, Mariakirchener Strasse 38,  
94424 Arnstorf, DE  
Designer: Christian Stepputat, Passau  
Vertreter: Schmauder & Partner AG, Patent- und  
Markenanwälte VSP, 8038 Zürich  
Priorität: EM, 17.10.2006; EM, 17.10.2006

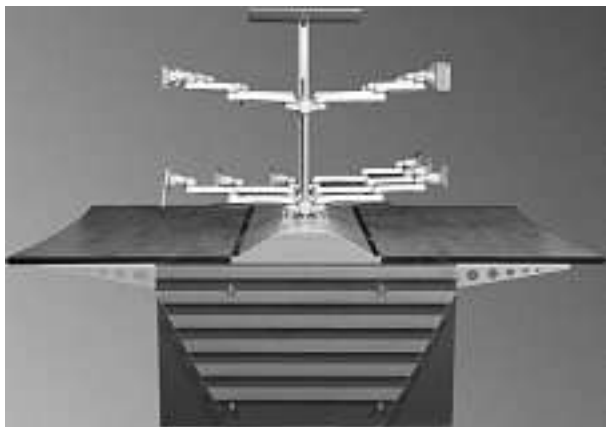

1  
1.1 Beschreibung des Designs: Ansicht auf die Stirnseite des Tisches mit beidseitigen Arbeitsflächen und Monitortragarmen in zwei Höhenebenen sowie mit Deckenleuchte.  
1.2: Seitenansicht von links auf die Arbeitsseite des Tisches mit beidseitigen Arbeitsflächen und Monitortragarmen in zwei Höhenebenen sowie mit Deckenleuchte.

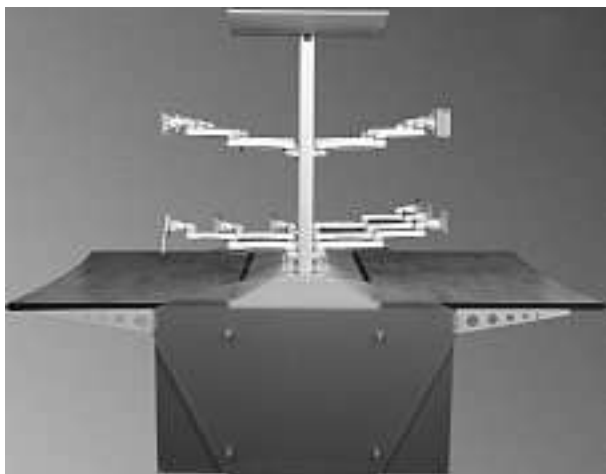

2  
2.1 Beschreibung des Designs: Ansicht auf die Stirnseite des Tisches mit beidseitigen Arbeitsflächen und Monitortragarmen in zwei Höhenebenen sowie mit Deckenleuchte.  
2.2: Seitenansicht von links auf die Arbeitsseite des Tisches mit beidseitigen Arbeitsflächen und Monitortragarmen in zwei Höhenebenen sowie mit Deckenleuchte.

Cl. 06-03 133 748 02.03.2007

1 Design – Tisch

Hinterleger: Markus Gähler, Welsikerstrasse 11, 8474 Dinhard  
Vertreter: wohnholz GmbH, 8451 Kleinandelfingen



Findling

Cl. 06-08 133 750 01.03.2007

2 design – cintres

Déposant: Margot Duboule, Place du Petit-Saconnex 8,  
1209 Genève  
Mandataire: Bugnion S.A., 1211 Genève 12 - Champel





1



2

Cl. 06-10 133 751 26.02.2007  
 6 Design – Gardinendekoration  
 Hinterleger: Nodeko GmbH, Im Schlahbruch 20-22,  
 59872 Meschede, DE  
 Designer: Ingo Ohle, Meschede  
 Vertreter: R. A. Egli & Co., Patentanwälte, 8008 Zürich  
 Priorität: EM, 28.08.2006

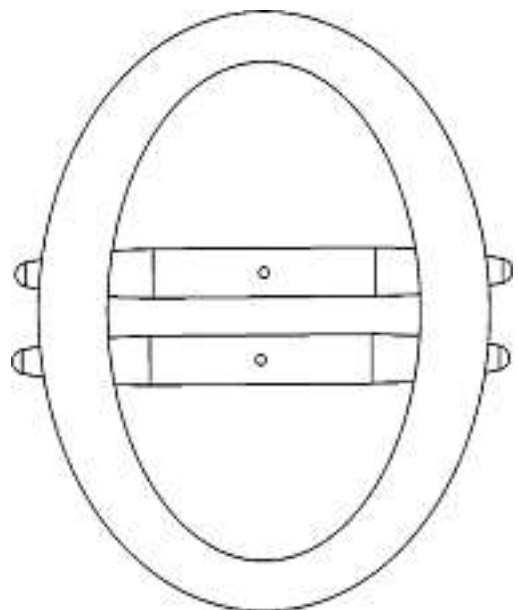
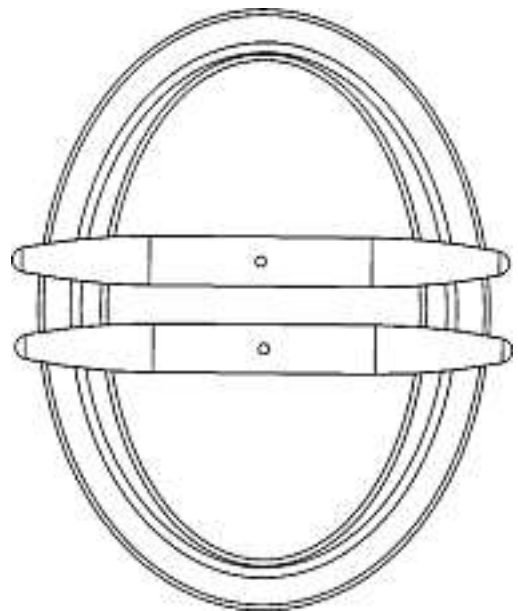
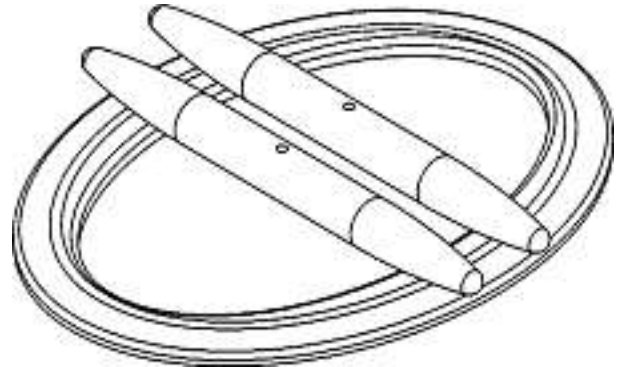



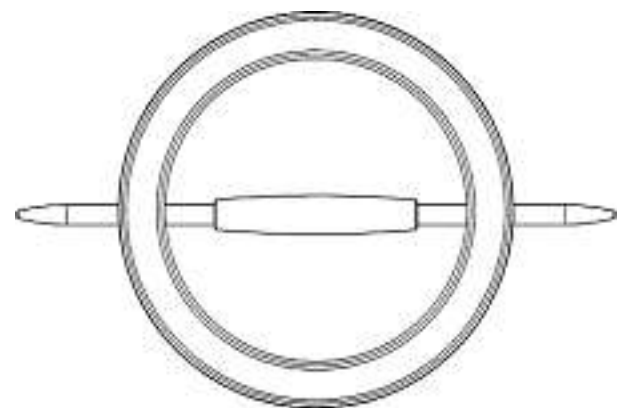
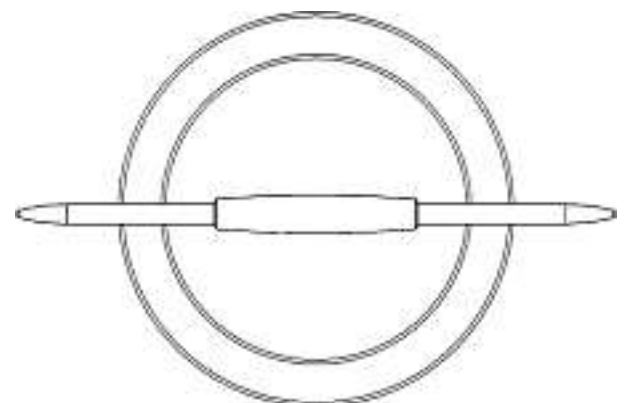
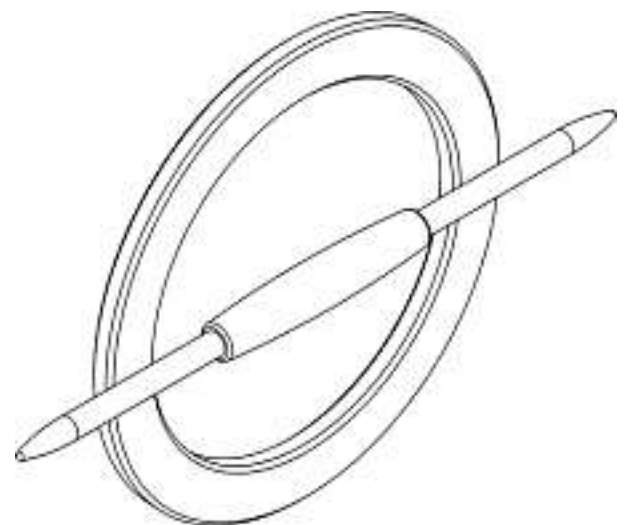
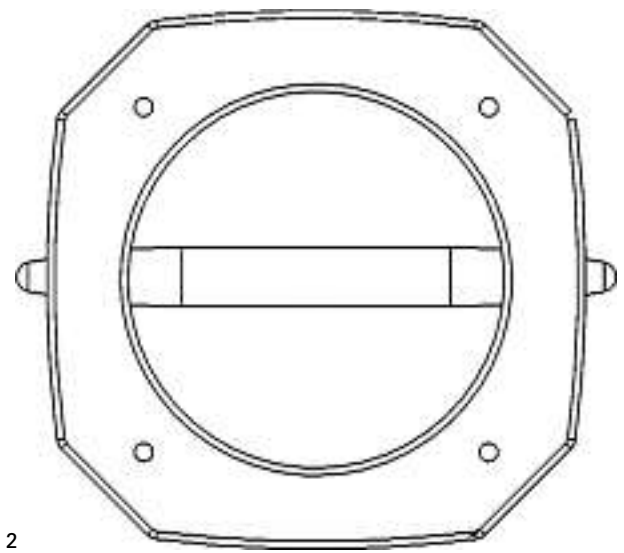
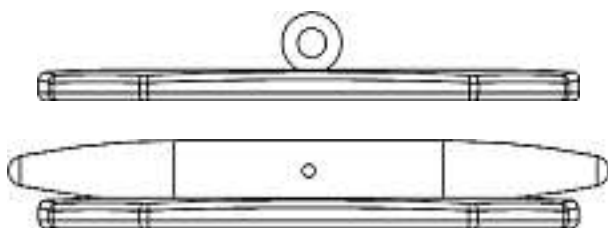
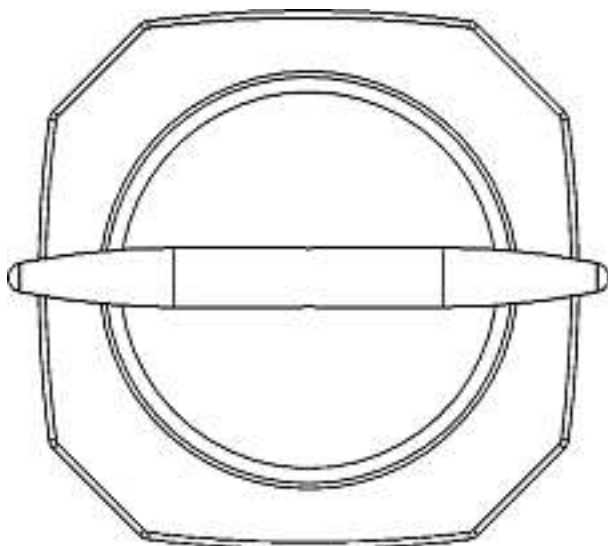
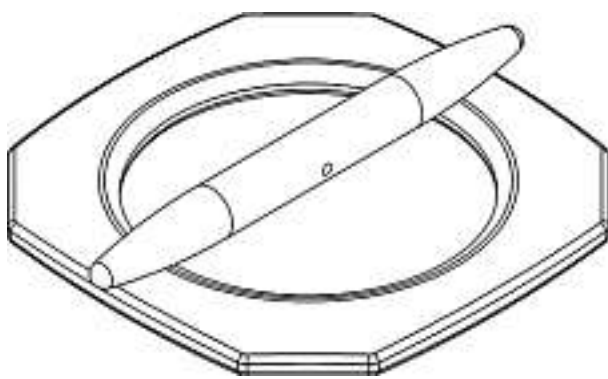
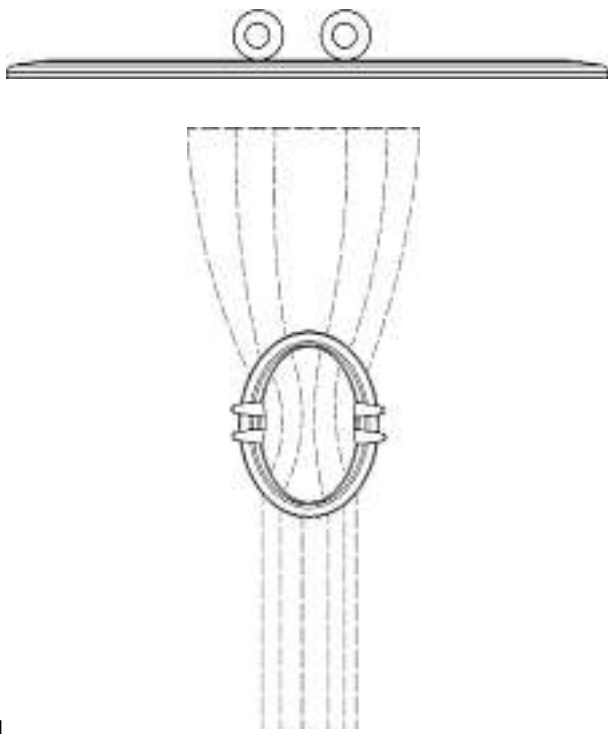

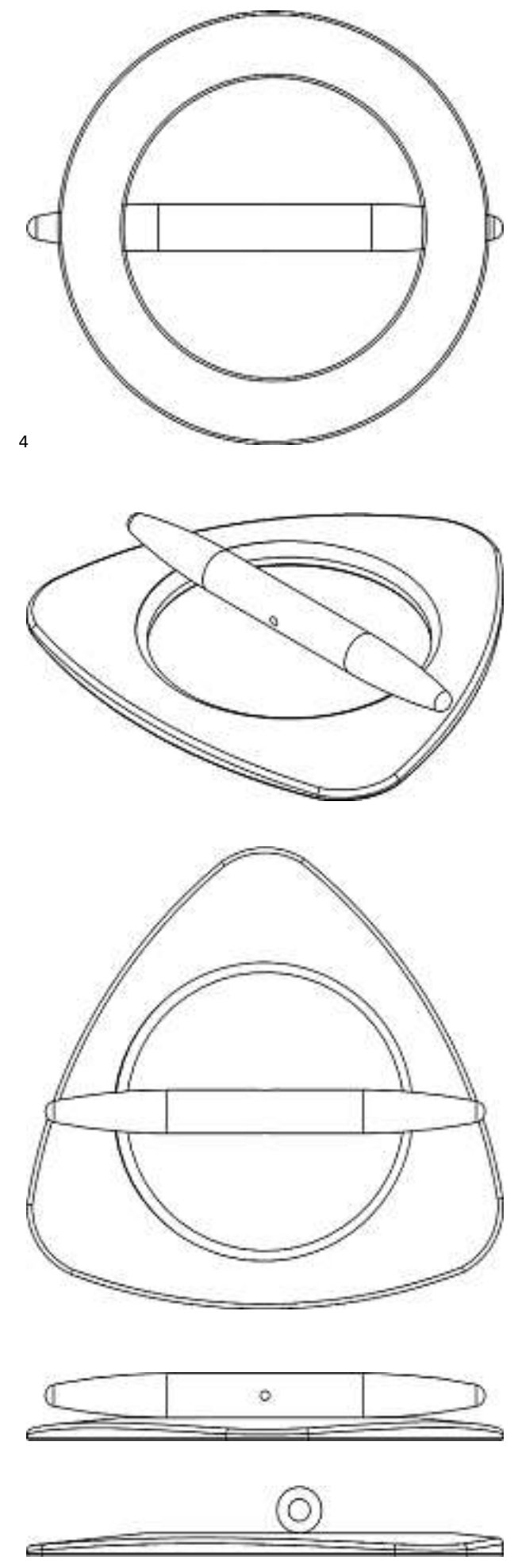
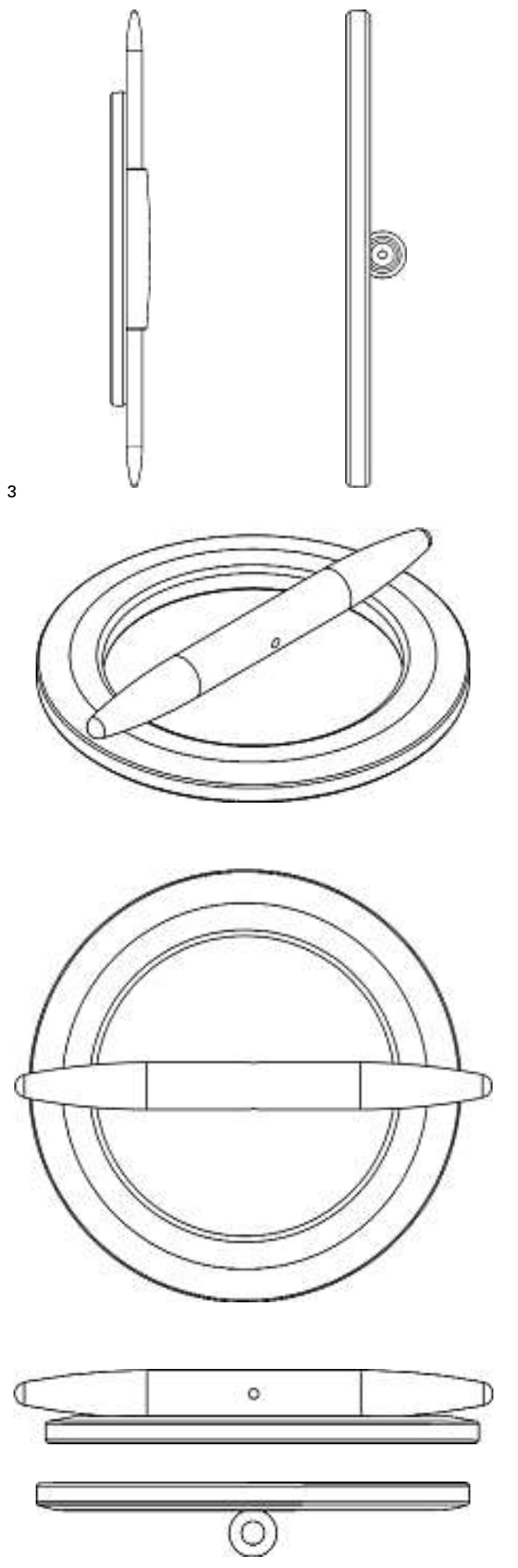

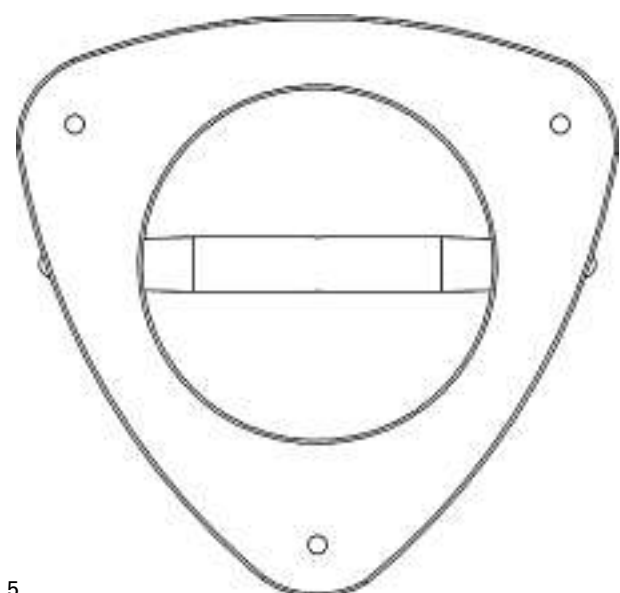

5

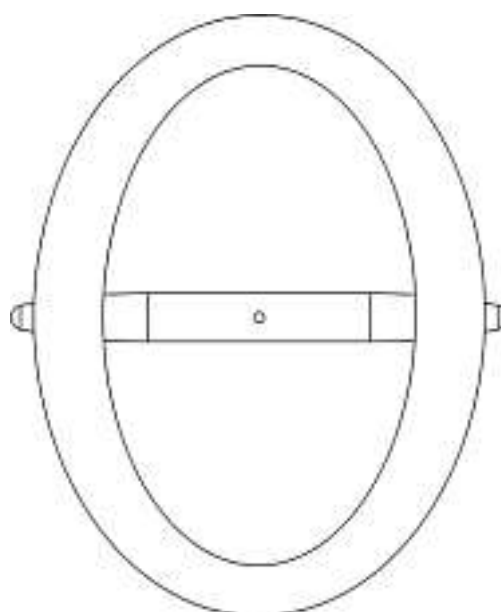
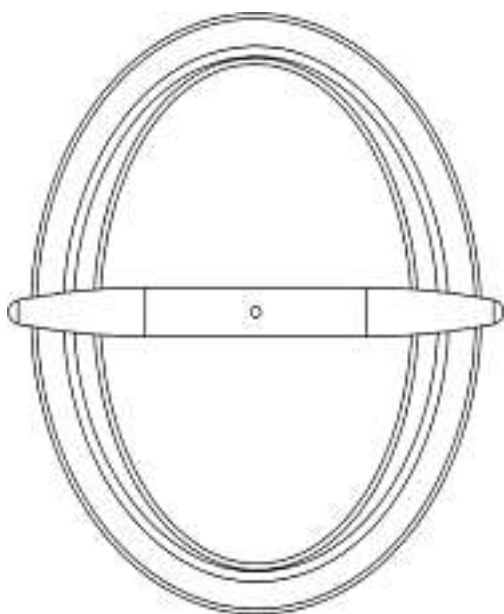
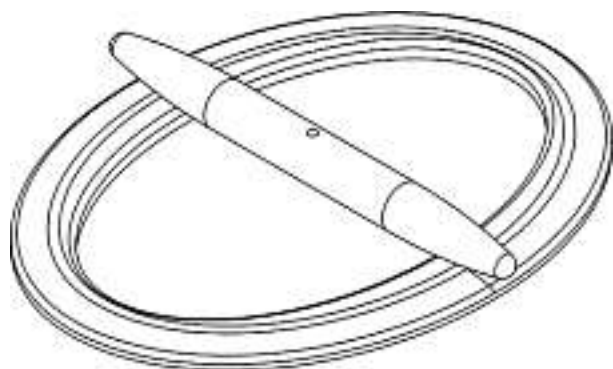

6

Cl. 07-05 133 753 06.03.2007  
 2 Design - Bügeleisen  
 Hinterleger: BSH Bosch und Siemens Hausgeräte GmbH,  
 Carl-Wery-Strasse 34, München, DE  
 Designer: Jörg Schröter, Gröbenzell  
 Vertreter: Isler & Pedrazzini AG, 8023 Zürich  
 Priorität: EM, 08.09.2006





M13229-1





M13229-2

Cl. 08-07 **133 754** 19.03.2007  
 1 Design – Tür- und Fensterstopper  
 Hinterleger: Frank F. E. Mayer, Gerberstrasse 8, 67098 Bad Dürkheim, DE  
 Vertreter: Schneider Feldmann AG, Patent- und Markenanwälte, 8002 Zürich  
 Priorität: EM, 25.09.2006  
 Beschreibung des Designs: Das Muster betrifft einen Tür- und Fensterstopper zur Verhinderung des Zuschlagens von Türen und Fenstern.  
 Der Stopper besteht aus einem gummielastischen Körper mit einem dicken gerundeten Endbereich und einem engeren zu einer Spitze auslaufenden sich verjüngenden und einwärts gezogenen Bereich. Er besitzt ein äusseres, weiches und ein innen steiferes Teil, die eine Ausnehmung umfassen. Zwei solcher Teile können zu einer Kreisscheibe zusammengefügt werden.  
 1 (Farbteil siehe Heftmitte)

Cl. 09-01 **133 755** 06.03.2007  
 1 Design – Flasche  
 Hinterleger: Société Anonyme des Eaux Minérales d'Evian, 22, avenue des Sources, 74503 Evian-les-Bains, FR  
 Designer: Erwann Pivert, Paris  
 Vertreter: E. Blum & Co. AG, Patent- und Markenanwälte VSP, 8044 Zürich  
 Priorität: EM, 12.01.2007

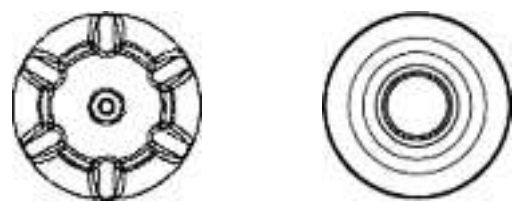

A-2007/1000

Cl. 09-03 **133 756** 01.03.2007  
 2 Design – Faltschachtel  
 Hinterleger: CP Schmidt Verpackungs-Werk GmbH & Co. KG, Merkurstrasse 22-26, Kaiserslautern, DE  
 Designer: Klaus J. Marszollek, Kaiserslautern  
 Vertreter: Kikinis Rohner Schwenninger Weinmann, 8032 Zürich

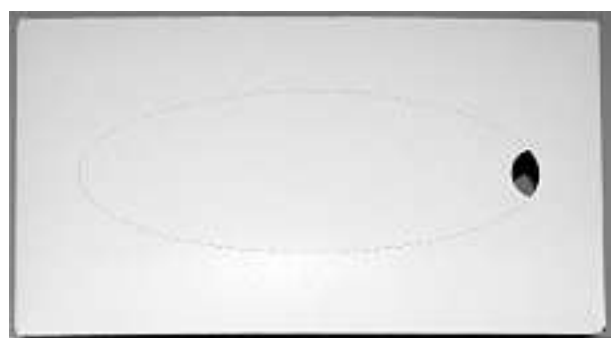

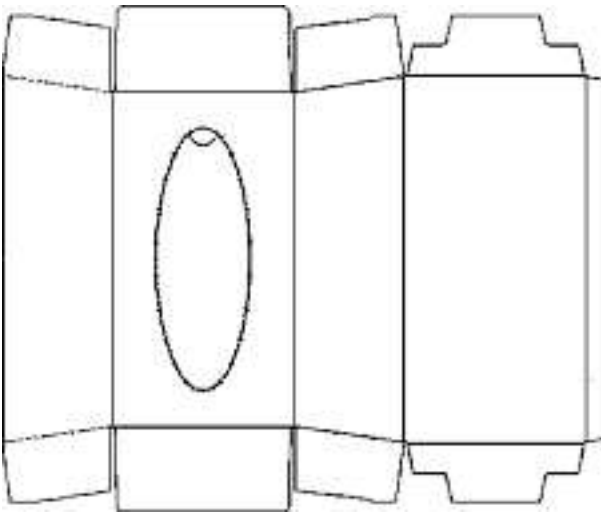

M-0002722V2-02

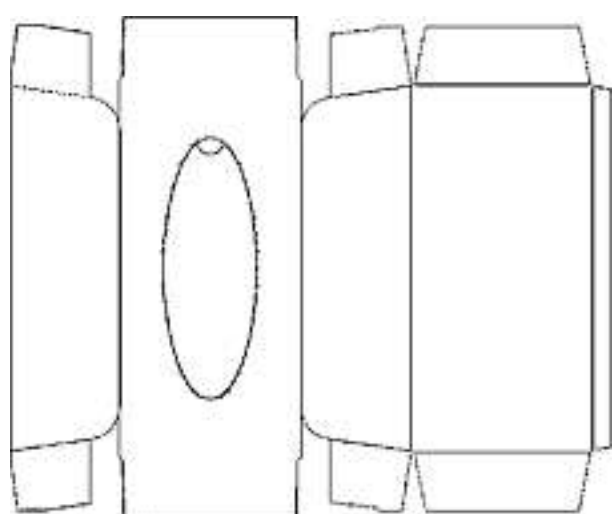

M-0002722V37

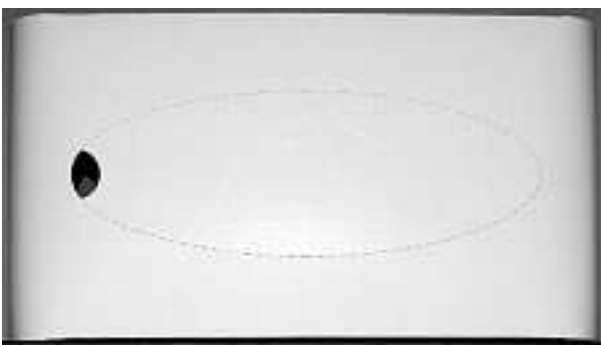

Cl. 09-03 **133 757** 01.03.2007  
 2 Design – Schachtel für Papiertücher  
 Hinterleger: Kimberly-Clark Limited, 1 Tower View, Kings Hill,  
 West Malling, Kent ME19 4HA, GB  
 Designer: Klaus J. Marszollek, Kaiserslautern  
 Vertreter: A. Braun, Braun, Héritier, Eschmann AG,  
 Patentanwälte, 4051 Basel





D35361CH00-2



D35361CH00-1

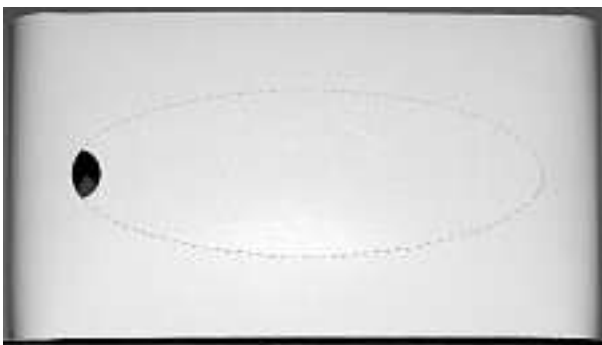

Cl. 09-03 133 758 07.03.2007

1 Design – Verpackungsbehälter  
Hinterleger: Alcan Technology & Management Ltd.,  
Badische Bahnhofstrasse 16, 8212 Neuhausen am Rheinfall  
Designer: Jan J. Middelbrink, Twello  
Priorität: EM, 16.11.2006

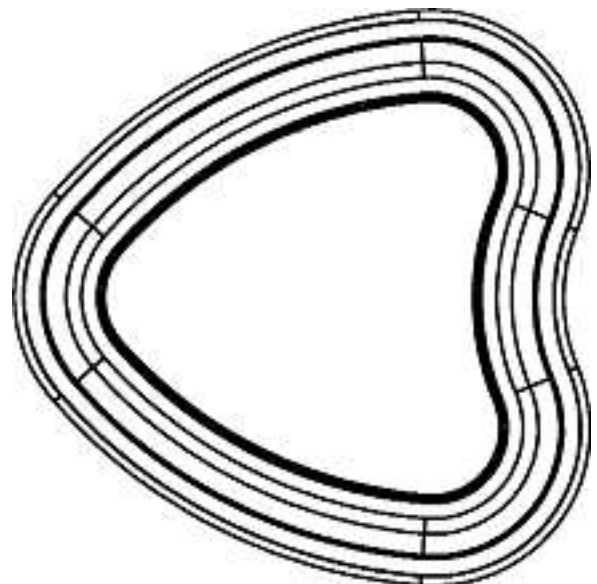
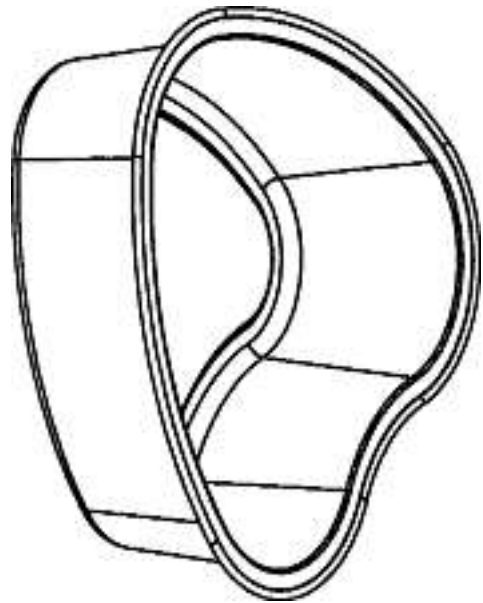



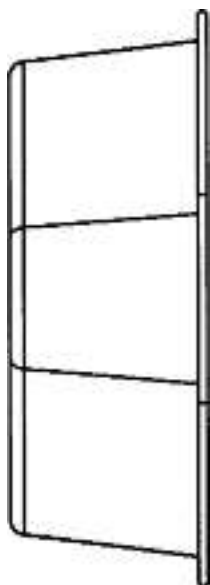

IR6762CH

Cl. 09-03 **133 759** 07.03.2007  
 1 Design – Verpackungsbehälter  
 Hinterleger: Alcan Technology & Management Ltd.,  
 Badische Bahnhofstrasse 16, 8212 Neuhausen am Rheinfall  
 Designer: Jan J. Middelbrink, Twello  
 Priorität: EM, 28.11.2006

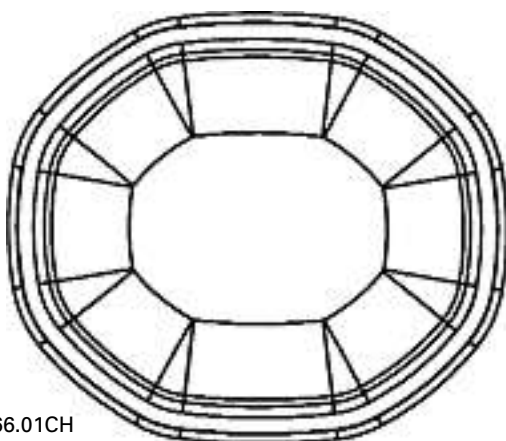
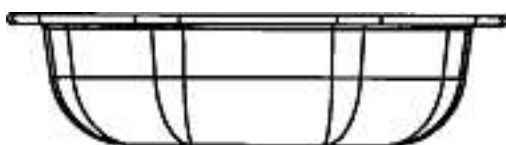
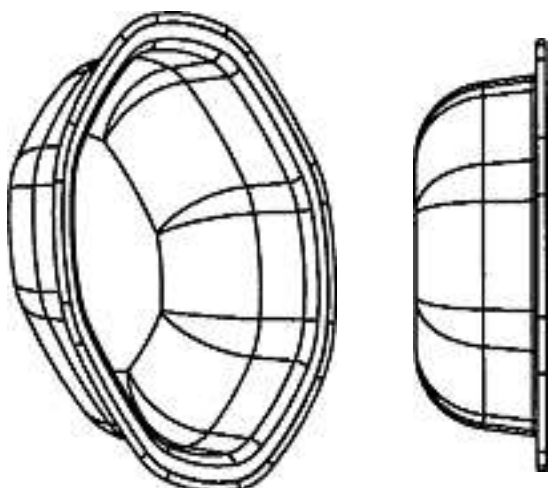

IR6766.01CH

Cl. 09-03 **133 760** 07.03.2007  
 1 Design – Verpackungsbehälter  
 Hinterleger: Alcan Technology & Management Ltd.,  
 Badische Bahnhofstrasse 16, 8212 Neuhausen am Rheinfall  
 Designer: Jan J. Middelbrink, Twello  
 Priorität: EM, 28.11.2006

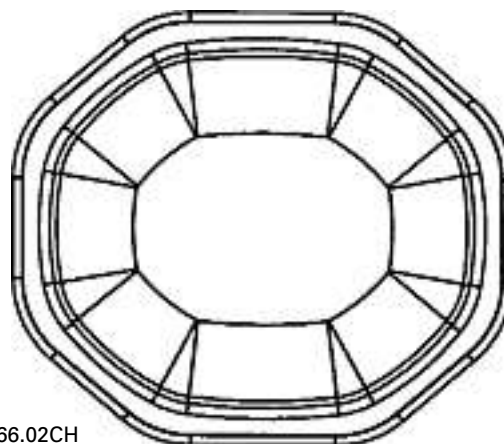
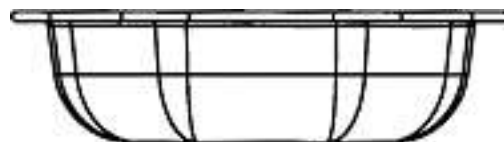
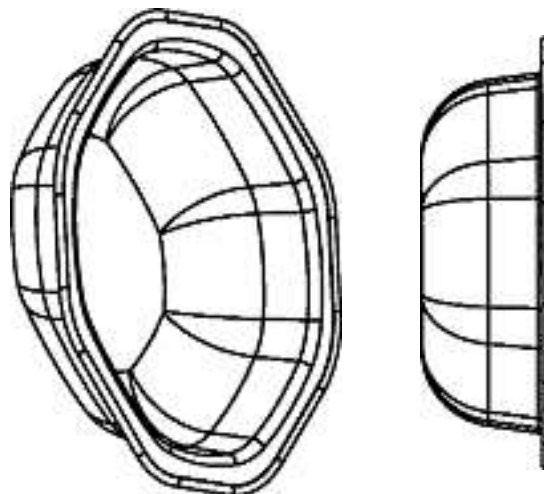

IR6766.02CH

Cl. 09-05 **133 762** 20.03.2007  
 2 Design – Standbeutel  
 Hinterleger: Magic Fruits Beauty Snack GmbH,  
 Prambeckenhof 1, 4720 Neumarkt im Hausruckkreis, AT  
 Designer: Hermann Trappmaier, Peuerbach  
 Vertreter: Isler & Pedrazzini AG, 8023 Zürich  
 Priorität: EM, 21.09.2006  
 M13311/1 (Farbteil siehe Heftmitte)  
 M13311/2 (Farbteil siehe Heftmitte)

Cl. 09-07 **133 763** 06.03.2007  
 1 Design – Deckel zu Flasche  
 Hinterleger: Société Anonyme des Eaux Minérales d'Evian,  
 22, avenue des Sources, 74503 Evian-les-Bains, FR  
 Designer: Erwann Pivert, Paris  
 Vertreter: E. Blum & Co. AG, Patent- und Markenanwälte VSP,  
 8044 Zürich  
 Priorität: EM, 12.01.2007

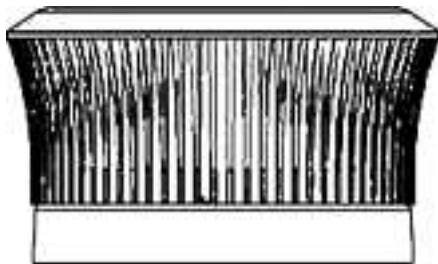

A-2007/1001

Cl. 10-02 133 764 03.01.2007  
 1 design – montre  
 Déposant: Georges Basas, 14 chemin du Moulin,  
 2802 Develier  
 Bi ONE 080357 (Farbteil siehe Heftmitte)

Cl. 10-02, 10-07 133 765 03.03.2007  
 6 Design – Uhren und Uhrenzifferblätter  
 Hinterleger: Rolf Dillmann AG, Theaterplatz 1, 3011 Bern  
 Designer: Daniel Dillmann, Stettlen  
 Vertreter: Advokaturbüro Beutler Künzi Stutz, 3000 Bern 6

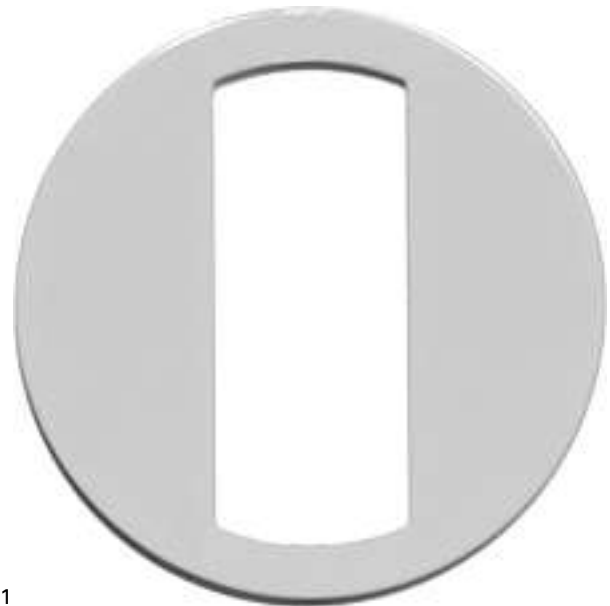

1

Beschreibung des Designs: Rundes Uhrenzifferblatt mit aus-  
 gestanztem, d.h. ausgeschnittenem Mittelsegment.

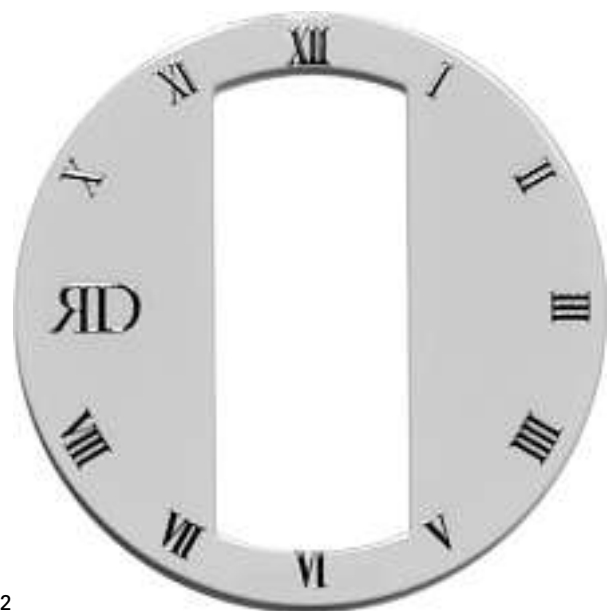

2

Beschreibung des Designs: Rundes Uhrenzifferblatt mit aus-  
 gestanztem, d.h. ausgeschnittenem Mittelsegment.



3



4



5



6

Cl. 10-02, 10-07      133 766      08.03.2007  
 3 design – orologi  
 Depositante: Haurex Italia S.r.l., Via Paolo Nanni Costa,  
 12/4 B, Bologna, IT  
 Designer: Giuseppe La Giusa, Bologna  
 Mandatario: Novagraaf International SA, 1220 Les Avanchets

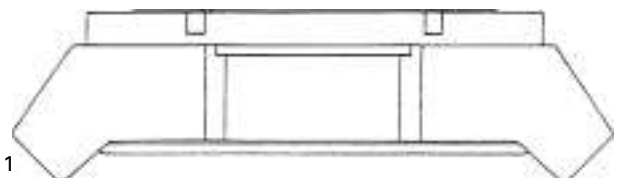
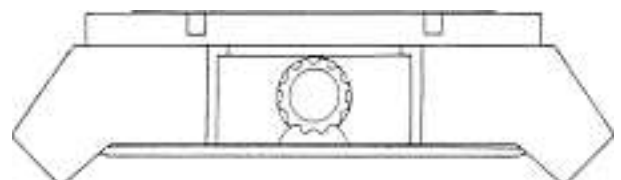

1

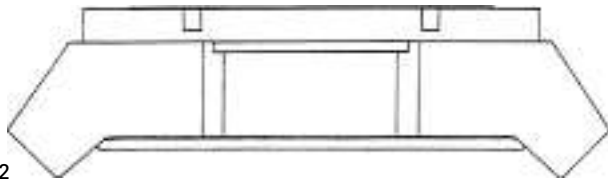
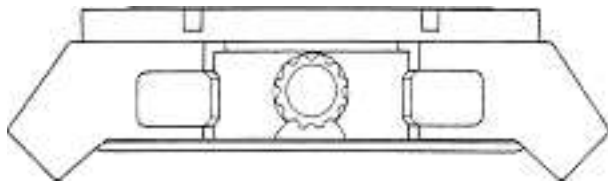

2

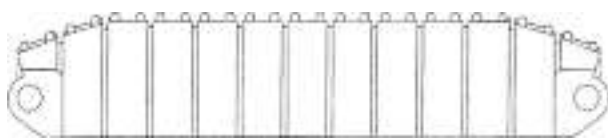
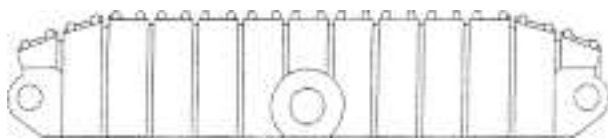

3

Cl. 10-02 **133 767** 04.04.2007  
 1 design – montre-bracelet  
 Déposant: Jeanrichard S.A., rue du Progrès 129,  
 2300 La Chaux-de-Fonds  
 Designer: Daniel Messina, Le Locle  
 Mandataire: Inteltech SA, 2001 Neuchâtel  
 1 (Farbteil siehe Heftmitte)

Cl. 10-07 **133 768** 12.03.2007  
 4 design – cadrans  
 Déposant: Montres Tudor S.A., 3, rue François Dussaud,  
 1211 Genève 26  
 Designer: Daniel Riedo, Collonge-Bellerive  
 Mandataire: Bugnion S.A., 1211 Genève 12 - Champel



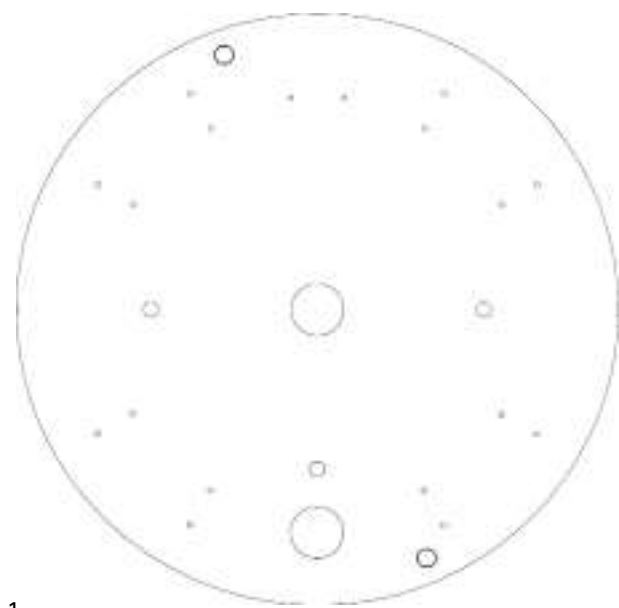

1

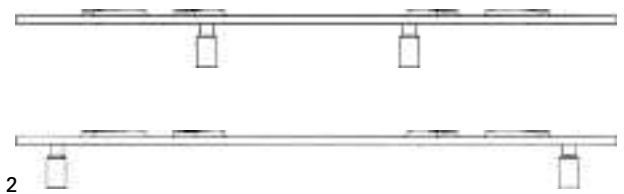
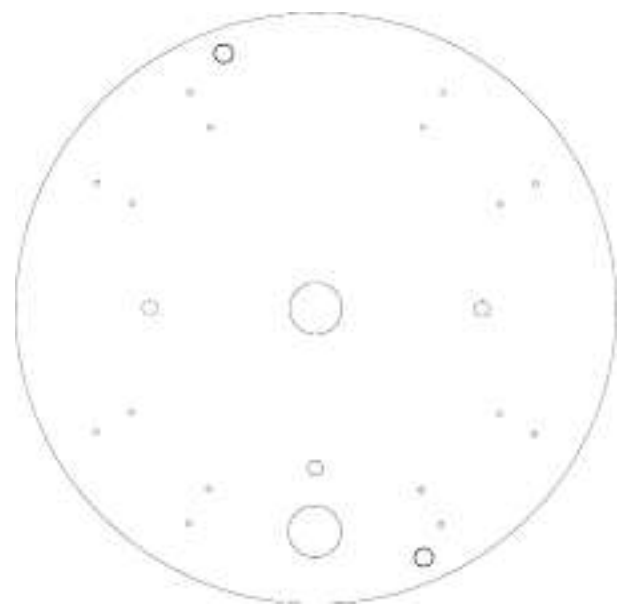

2

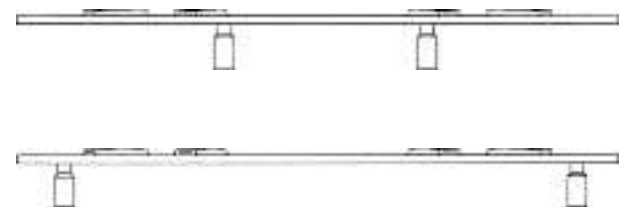

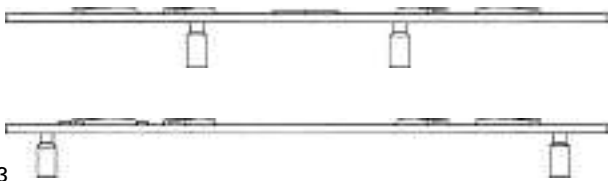
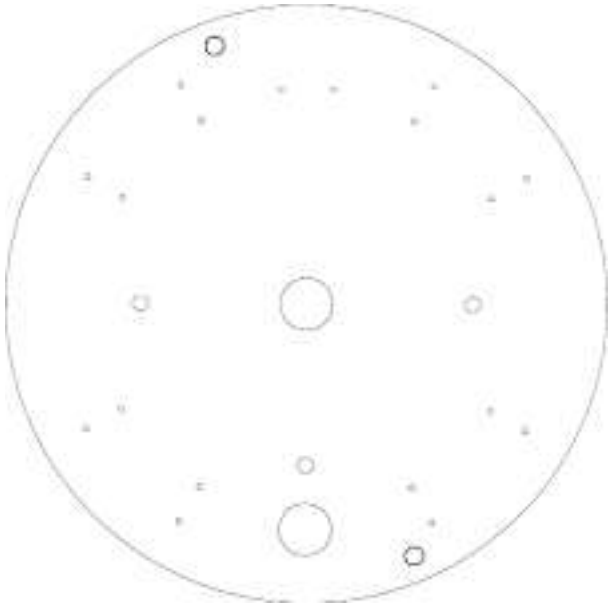
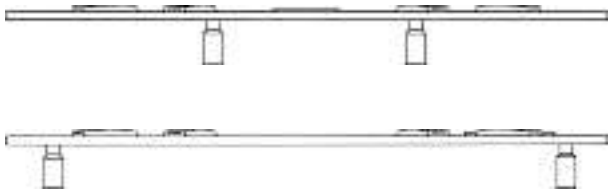

3

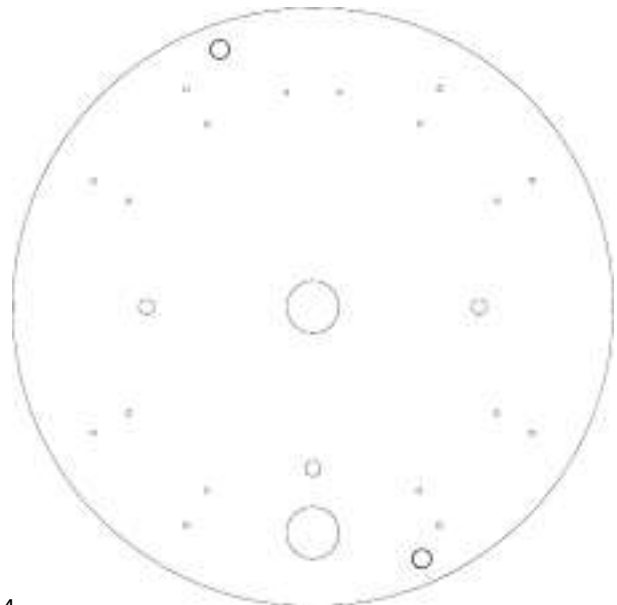
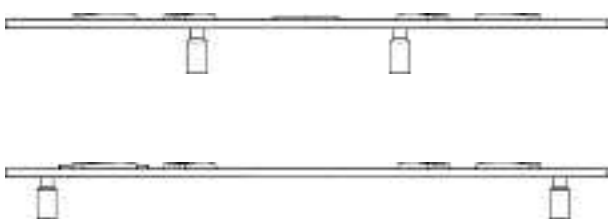
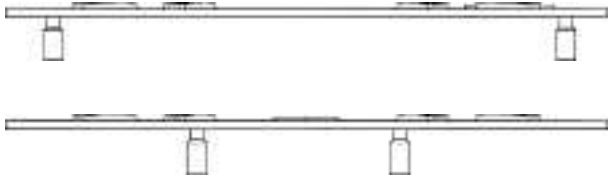
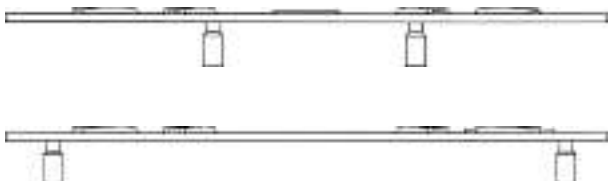

4

Cl. 10-07 133 769 30.03.2007

21 Design – Uhrarmband  
 Hinterleger: Hirsch Armbänder GmbH, Hirschstrasse 5,  
 Klagenfurt, AT

Designer: Markus Kerker, Klagenfurt  
 Vertreter: Schmauder & Partner AG, Patent- und  
 Markenanwälte VSP, 8038 Zürich

- 1 (Farbteil siehe Heftmitte)
- 2 (Farbteil siehe Heftmitte)
- 3 (Farbteil siehe Heftmitte)
- 4 (Farbteil siehe Heftmitte)
- 5 (Farbteil siehe Heftmitte)
- 6 (Farbteil siehe Heftmitte)
- 7 (Farbteil siehe Heftmitte)
- 8 (Farbteil siehe Heftmitte)
- 9 (Farbteil siehe Heftmitte)
- 10 (Farbteil siehe Heftmitte)
- 11 (Farbteil siehe Heftmitte)
- 12 (Farbteil siehe Heftmitte)
- 13 (Farbteil siehe Heftmitte)
- 14 (Farbteil siehe Heftmitte)
- 15 (Farbteil siehe Heftmitte)
- 16 (Farbteil siehe Heftmitte)
- 17 (Farbteil siehe Heftmitte)
- 18 (Farbteil siehe Heftmitte)
- 19 (Farbteil siehe Heftmitte)
- 20 (Farbteil siehe Heftmitte)
- 21 (Farbteil siehe Heftmitte)

Cl. 11-01 **133 771** 05.03.2007  
 7 Design – Schmuck- und Juwelierwaren  
 Hinterleger: Sunny Creations Limited, Suites 1003-4, 10/F.,  
 Hilder Centre, 2 Sung Ping Street, Hung Hom, Kowloon, HK  
 Designer: Fannie Suk Fan Ng, Kowloon  
 Vertreter: Wild Schnyder AG, 8032 Zürich  
 1 (Farbteil siehe Heftmitte)  
 2 (Farbteil siehe Heftmitte)  
 3 (Farbteil siehe Heftmitte)  
 4 (Farbteil siehe Heftmitte)  
 5 (Farbteil siehe Heftmitte)  
 6 (Farbteil siehe Heftmitte)  
 7 (Farbteil siehe Heftmitte)



Cl. 11-01 **133 772** 26.03.2007  
 2 Design – Schmuck  
 Hinterleger: Sunny Creations Limited, Suites 1003-4, 10/F.,  
 Hilder Centre, 2 Sung Ping Street, Hung Hom, Kowloon, HK  
 Designer: Fannie Suk Fan Ng, Kowloon  
 Vertreter: Wild Schnyder AG, 8032 Zürich  
 1 (Farbteil siehe Heftmitte)  
 2 (Farbteil siehe Heftmitte)

Cl. 11-01 **133 773** 28.03.2007  
 2 Design – Schmuck  
 Hinterleger: Sunny Creations Limited, Suites 1003-4, 10/F.,  
 Hilder Centre, 2 Sung Ping Street, Hung Hom, Kowloon, HK  
 Designer: Fannie Suk Fan Ng, Kowloon  
 Vertreter: Wild Schnyder AG, 8032 Zürich  
 Priorität: EM, 13.11.2006  
 1 (Farbteil siehe Heftmitte)  
 2 (Farbteil siehe Heftmitte)



D-2044/07-S1

Cl. 12-16 **133 774** 02.03.2007  
 3 design – ruote per veicoli  
 Depositante: Eta Beta S.p.A., Via Brescia 53/A,  
 25014 Castenedolo (Brescia), IT  
 Designer: Francesco Notaristefano, Castenedolo  
 Mandatario: Jacobacci & Partners S.A., 1207 Genève







D-2044/07-S2

D-2044/07-S3



Cl. 13-03 **133 775** 14.03.2007  
 2 design – adaptateur de puissance, adaptateur de tension  
 Déposant: Combotronic Limited, Flat A, 10th Floor, Hop Lung  
 Factory Building, 1 Mong Lung Street, Shaukiwan, Hong  
 Kong, HK  
 Designer: Kam Wah So, Hong Kong  
 Mandataire: Bugnion S.A., 1211 Genève 12 - Champel

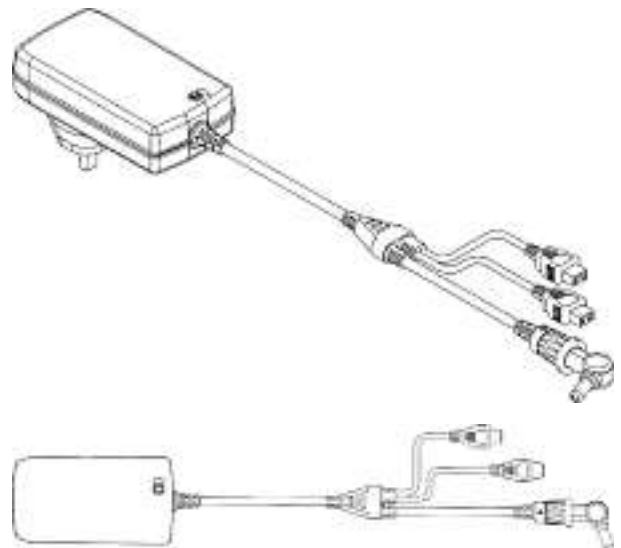



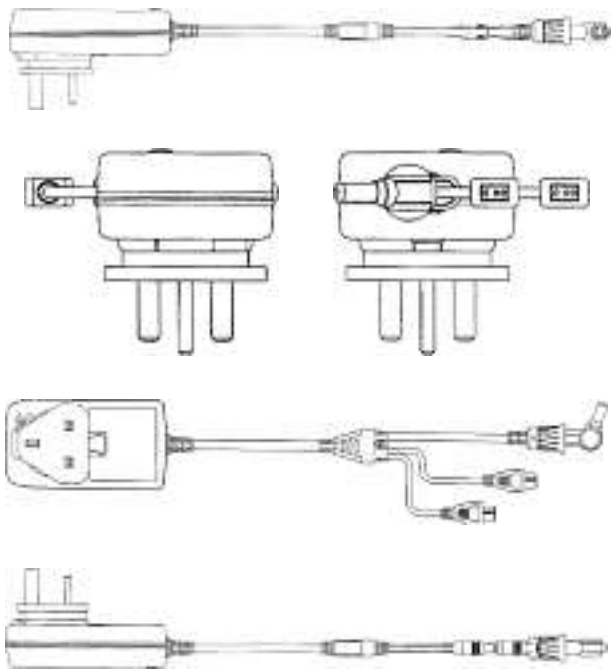

1

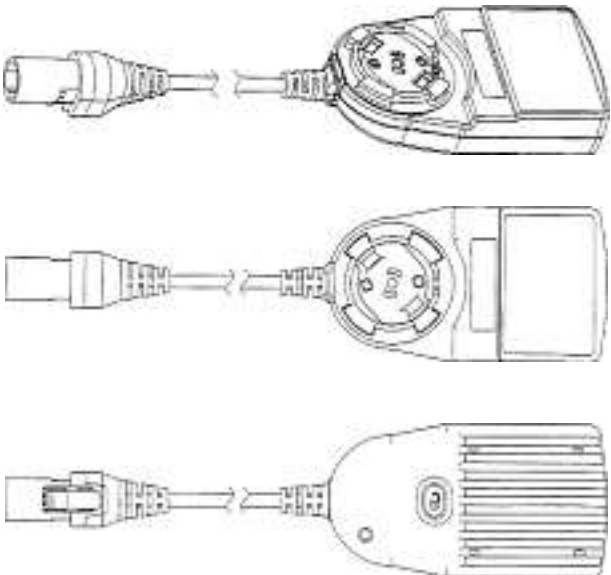

2

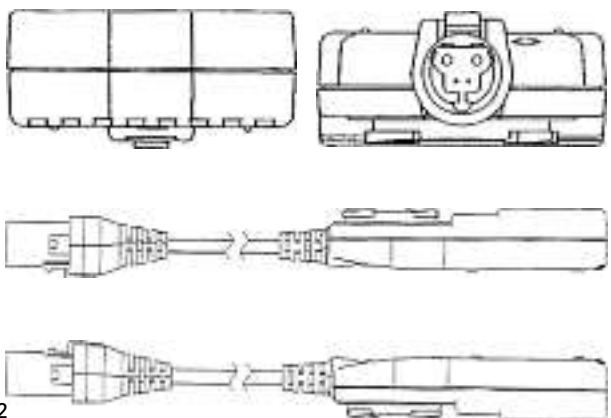

Cl. 14-03 133 776 28.02.2007  
 3 Design – Telefonendgerät und Basisstation  
 Hinterleger: swissvoice sa, chemin des Mûriers 1,  
 1170 Aubonne  
 Designer: Adrien Adeline, Draveil  
 Vertreter: Peter Rutz, 6304 Zug



D 1013 CH-1



D 1013 CH-2



Cl. 14-03 133 777 09.03.2007  
1 Design – Megafon  
Hinterleger: Peter Bachmann, Bucheggstrasse 121,  
8057 Zürich, ; Radovan Milanovic, Bucheggstrasse 121,  
8057 Zürich  
Vertreter: Peter Bachmann, 8057 Zürich

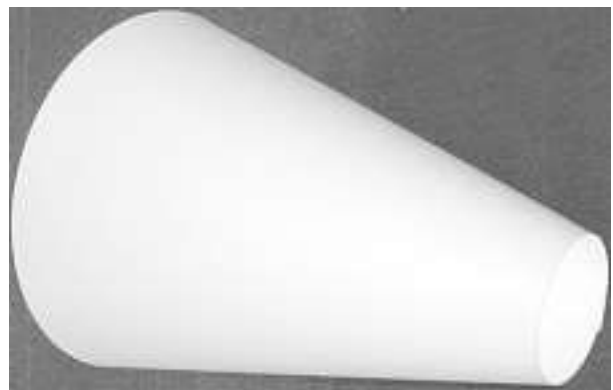



FF01

Cl. 14-99 **133 778** 09.03.2007  
 1 design – support pour dispositif électronique  
 Déposant: Sony Computer Entertainment Inc., 2-6-21,  
 Minami-Aoyama, Minato-ku, Tokyo, JP  
 Designer: Taihei Muraoka, Tokyo  
 Mandataire: MICHELI & CIE SA, 1226 Thônex  
 Priorité: JP, 04.12.2006

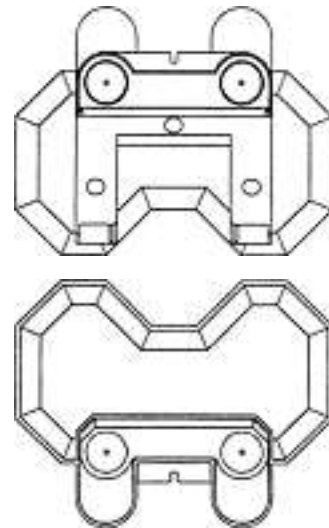
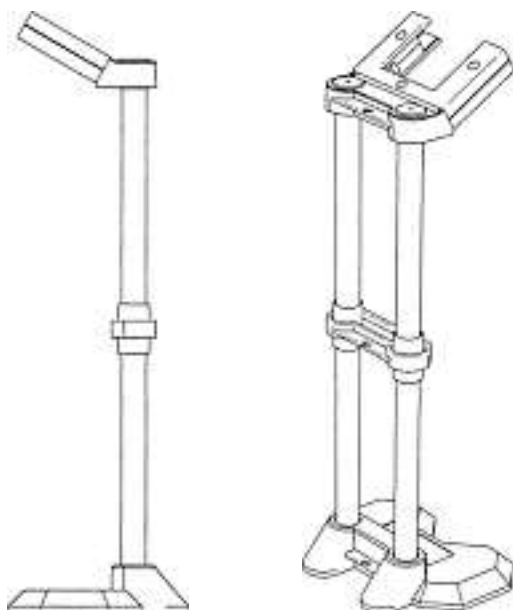
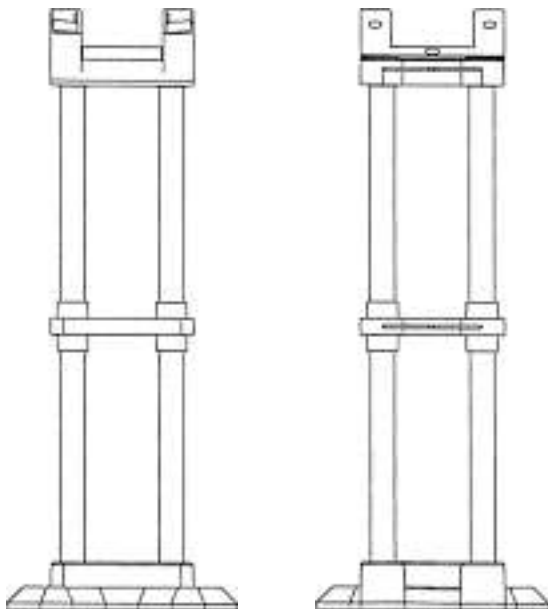

14958 CH

Cl. 15-07 **133 779** 13.04.2007  
 1 design – machines et appareils de réfrigération  
 Déposant: Société des Produits Nestlé SA, 1800 Vevey  
 Designer: Frank Rousselin, Voiron  
 Mandataire: Nestec S.A., 1800 Vevey

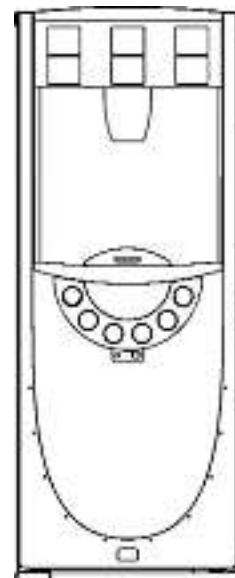
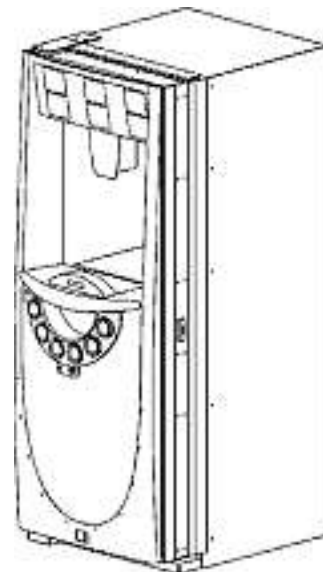

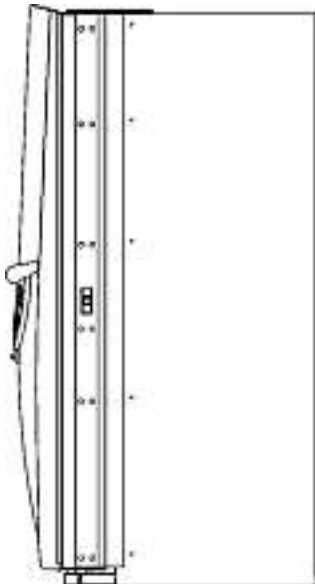
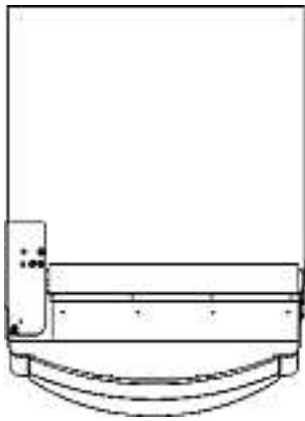

FL 65160

Cl. 15-09 **133 780** 15.03.2007  
 1 Design – Schweissautomat  
 Hinterleger: LEISTER Process Technologies, Riedstrasse, 6060 Sarnen  
 Designer: Lukas Gisler, Alpnach Dorf; Adolf Niederberger, Kägiswil  
 Vertreter: ABACUS Patentanwälte, Klocke Späth Barth, 8134 Adliswil  
 Beschreibung des Designs: Schweissautomat mit einem grünen Gehäuse, das stirnseitig abgerundet ist und eine

Aufnahme für eine Ersatzanpressrolle, sowie auf der dem Heissluftgerät zugewandten Seite ein andersfarbiges Schutzblech aufweist  
 480/121 CH (Farbteil siehe Heftmitte)

Cl. 19-06 **133 781** 02.03.2007  
 4 design – penna a biglia, matita a mina  
 Depositante: Mirko Cambianica, Via San Giüli, 6528 Camorino  
 Designer: Luca Cambianica, Tenero



indicus001

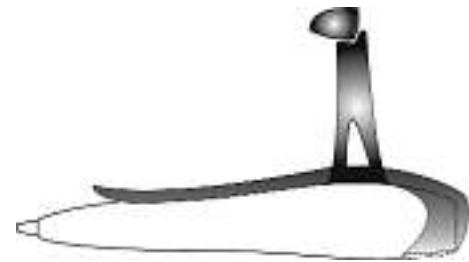

indicus002



indicus003





indicus004

Cl. 21-02 133 782 06.03.2007

1 design – article de sport

Déposant: Roger Schaefer, Chemin de Lallèx 13, 1091 Grandvaux

Description du design: Appareil conçu pour amincir le tour de taille. Les pieds sont engagées dans des chaussures fixées sur un plateau pivotant. Deux roues viennent fixées en dessous du plateau. L'équilibre du corps est maintenu par l'appui des mains sur une barre fixée au mur.



amincisseur du tour de taille

Cl. 21-02 133 783 19.03.2007

1 design – support pour chaussure de ski

Déposant: David R. Sellers, 3305 County Road 96, Ward, CO, US

Mandataire: MICHELI &amp; CIE SA, 1226 Thônex

Priorité: US, 22.09.2006

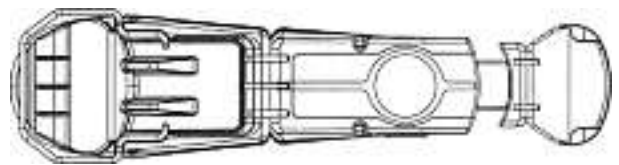
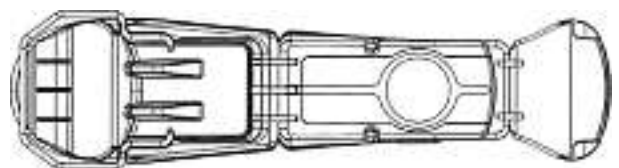
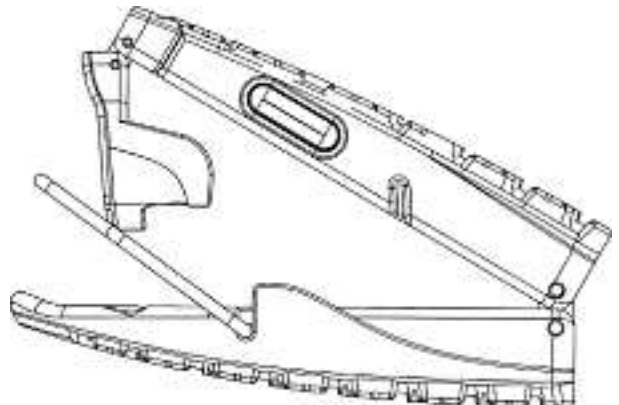
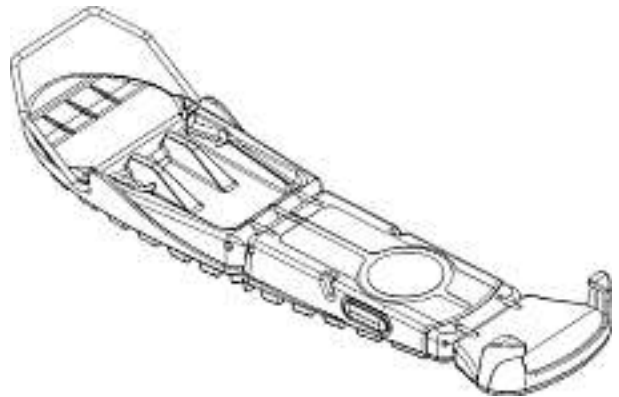
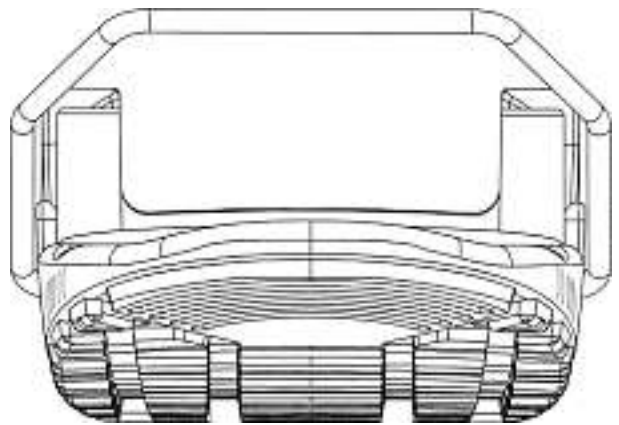
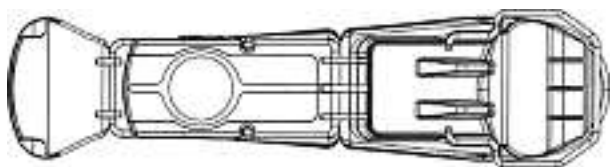

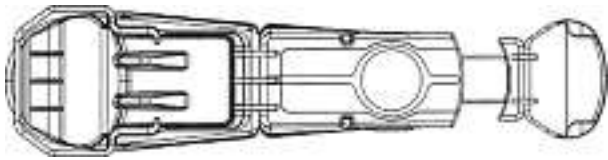

14818A

Cl. 23-03 133 785 05.03.2007  
 6 Design – Heizflächen  
 Hinterleger: Zehnder Verkaufs- und Verwaltungs-AG,  
 Moortalstrasse 1, 5722 Gränichen  
 Designer: René Hotz, Olten; Giovanni Suma, Gretzenbach  
 Vertreter: E. Blum & Co. AG, Patent- und Markenanwälte  
 VSP, 8044 Zürich  
 Priorität: EM, 05.09.2006

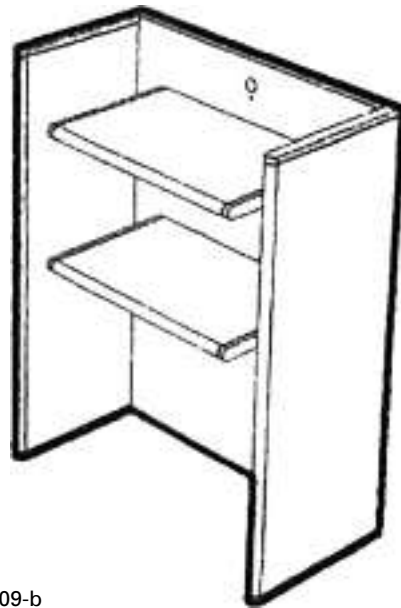

A-2007/1009-b

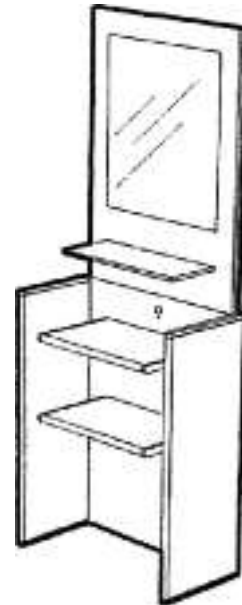

A-2007/1009-c

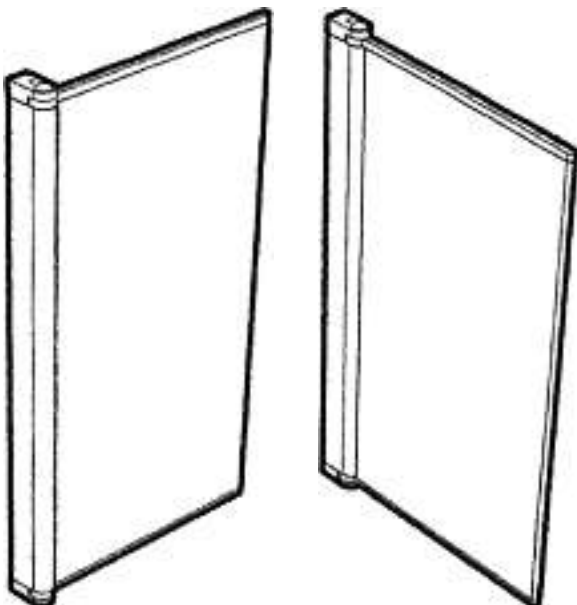

A-2007/1009-a

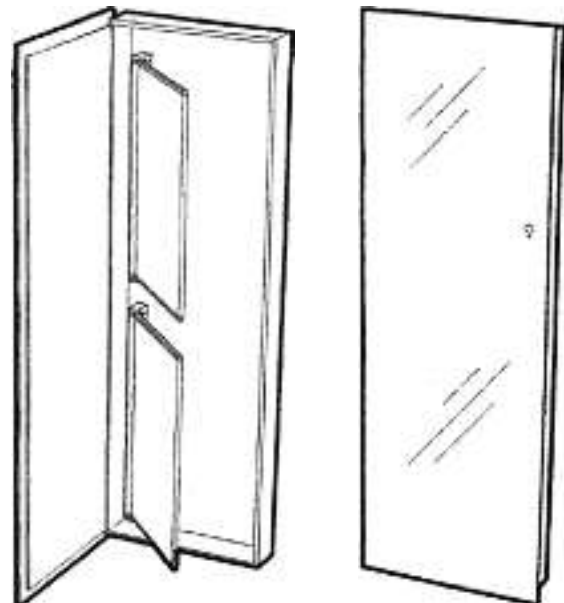

A-2007/1009-d

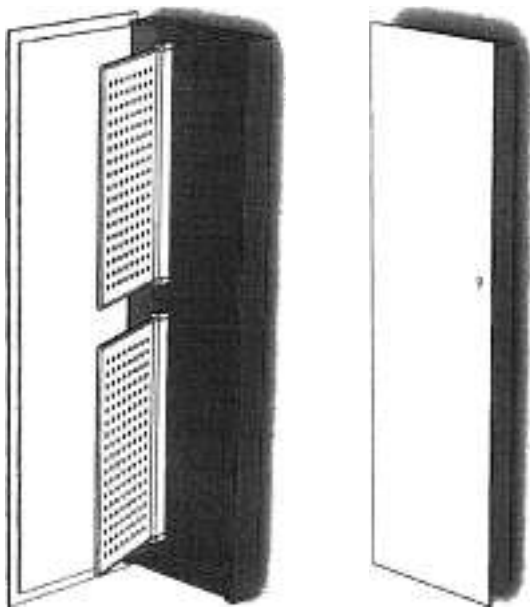

A-2007/1009-e

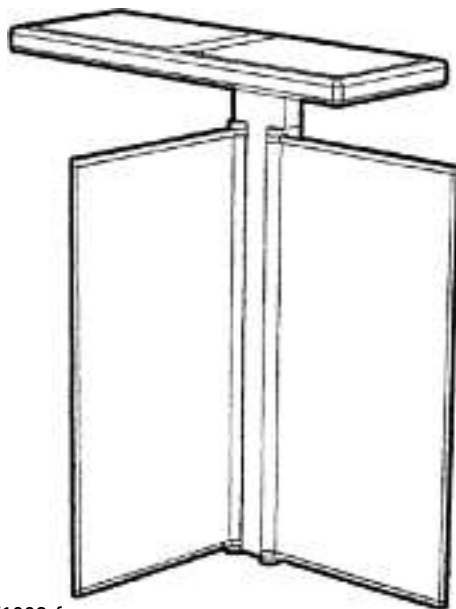

A-2007/1009-f

Cl. 24-02 **133 786** 26.03.2007  
 6 Design – Untersuchungsgerät  
 Hinterleger: Inverness Medical Switzerland GmbH,  
 Bundesplatz 1, 6300 Zug  
 Designer: Paul Laverack, Milton Keynes  
 Vertreter: E. Blum & Co. AG, Patent- und Markenanwälte  
 VSP, 8044 Zürich  
 Priorität: GB, 27.09.2006



1



2



3

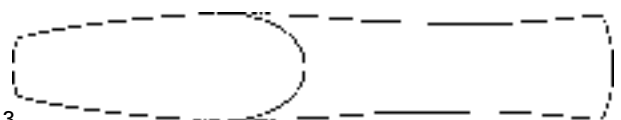

4

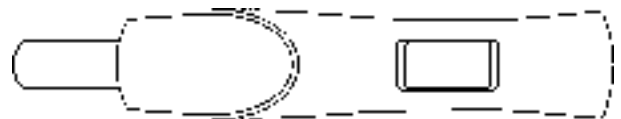

5

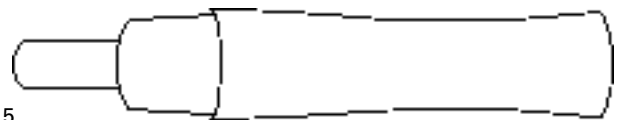

6

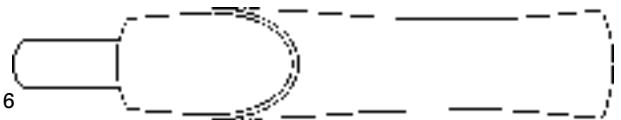

Cl. 25-03 **133 787** 15.03.2007  
 3 Design – Veranstaltungsplattform, Arena  
 Hinterleger: Bloch Guggenbühl Associates AG, Räf-  
 strasse 32, 8045 Zürich  
 Designer: Roland Imboden, Zürich; Philipp Lischer, Zürich;  
 Martin Bloch, Zürich  
 Vertreter: Advokaturbüro Beutler Künzi Stutz, 3000 Bern 6  
 1 (Farbteil siehe Heftmitte)  
 Beschreibung des Designs: «Auf dem Wasser schwimmende  
 Plattform zur Durchführung von Open-Air-Veranstaltungen,  
 mit Leinwand zur Vorführung von Filmen und zur Übertra-  
 gung von Sendungen»  
 2 (Farbteil siehe Heftmitte)  
 Beschreibung des Designs: «Auf dem Wasser schwimmende  
 Plattform zur Durchführung von Open-Air-Veranstaltungen,  
 mit Leinwand zur Vorführung von Filmen und zur Übertra-  
 gung von Sendungen»  
 3 (Farbteil siehe Heftmitte)

Cl. 26-05 **133 788** 02.03.2007  
 1 Design – Lampe  
 Hinterleger: Berner GmbH, Bernerstrasse 6,  
 74653 Künzelsau, DE  
 Designer: Gökhan Kizilay, Kupfer  
 Vertreter: Troesch Scheidegger Werner AG, Patent- und  
 Markenanwälte, 8126 Zumikon  
 Priorität: EM, 05.09.2006

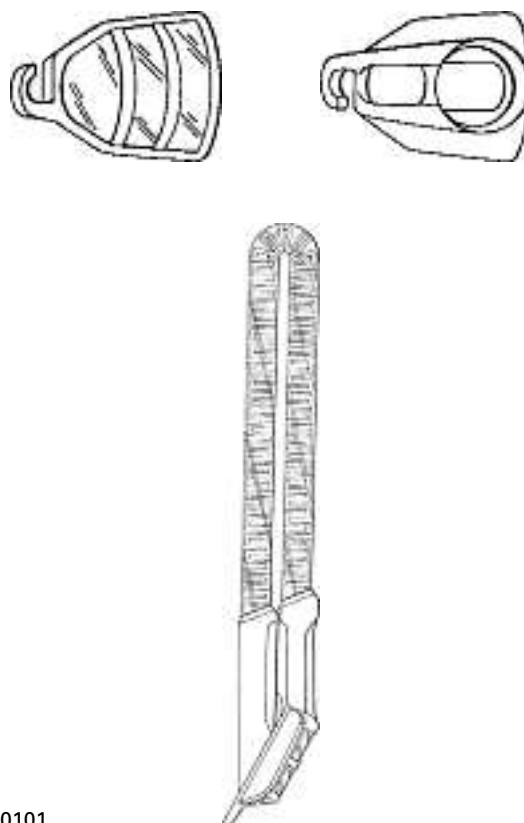
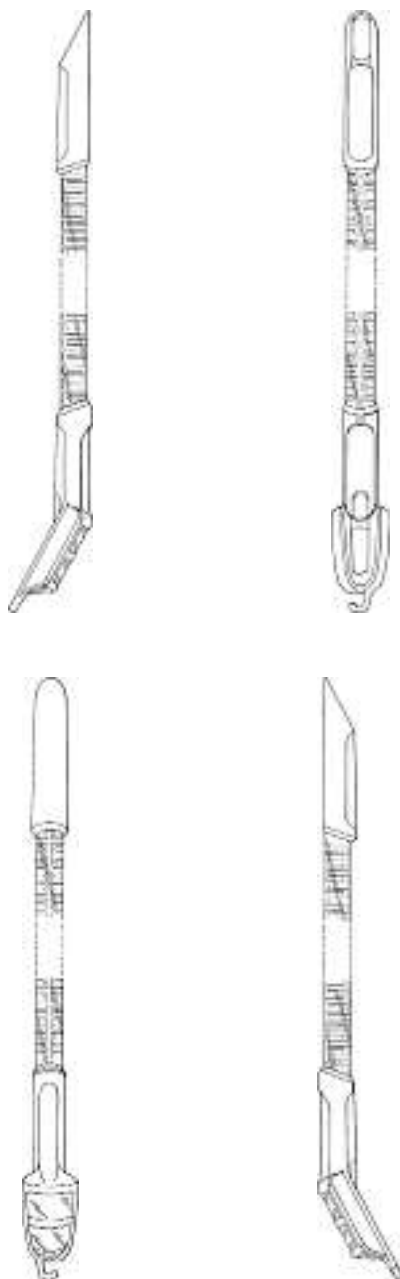

D300101

Cl. 26-05 **133 789** 26.03.2007  
 3 design – lampe, réflecteur  
 Dépositant: Witte & Sutor Gesellschaft mit beschränkter  
 Haftung, Steinberger Strasse 6, 71540 Murrhardt, DE  
 Designer: Waldemar Witte, Mainz  
 Mandataire: MICHELI & CIE SA, 1226 Thônex  
 Priorité: EM, 30.09.2006







14969A



14969B

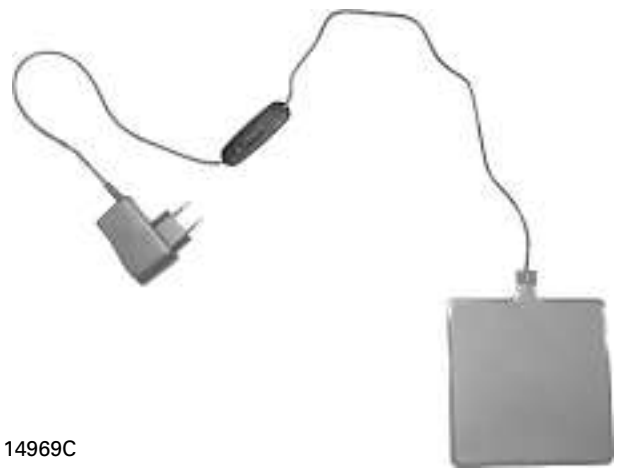

14969C

Cl. 26-06 133 790 22.03.2007  
2 design – gruppi ottici anteriori e posteriori per motorscooter  
Depositante: Honda Motor Co., Ltd., No. 1-1, 2-chome,  
Minami-aoyama, Minato-ku, Tokyo, JP  
Designer: Haruo Shimada, Saitama-ken; Yoshitaka Kubota,  
Saitama-ken; Maurizio Carbonara, Roma  
Mandatario: Fiammenghi-Fiammenghi, 6900 Lugano  
Priorità: JP, 29.09.2006; JP, 29.09.2006

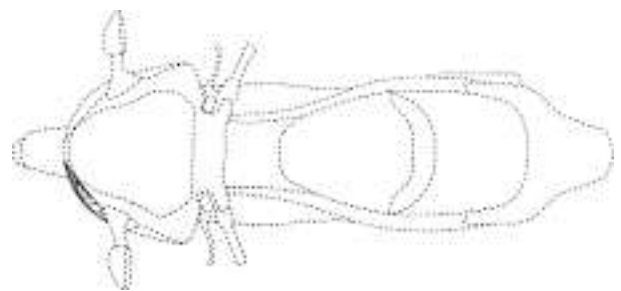
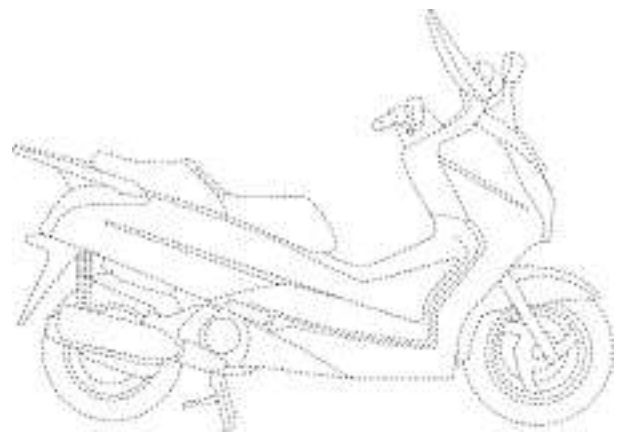
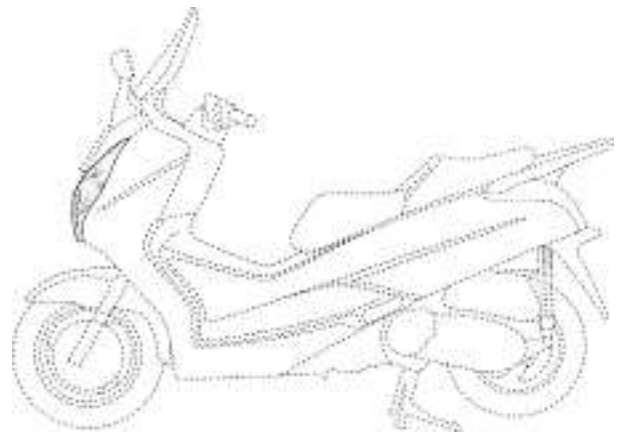
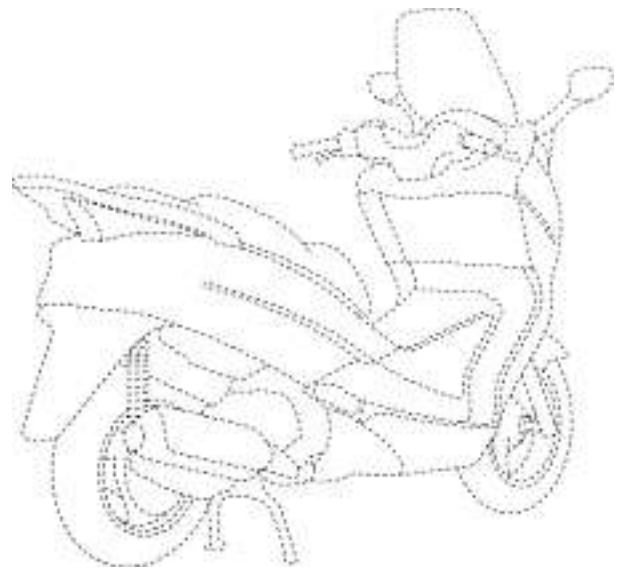
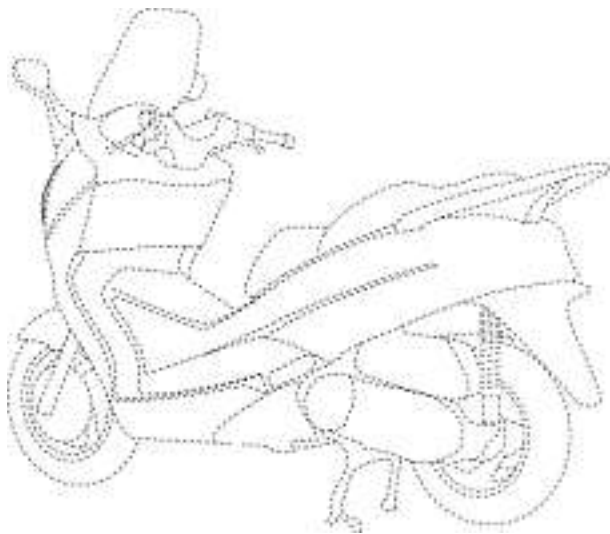

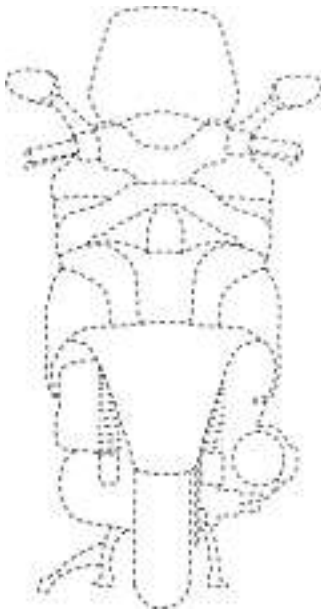
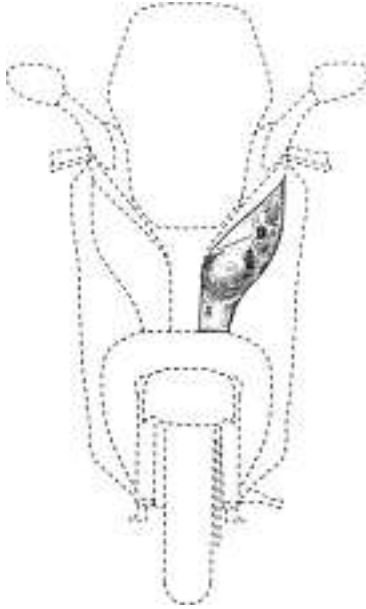
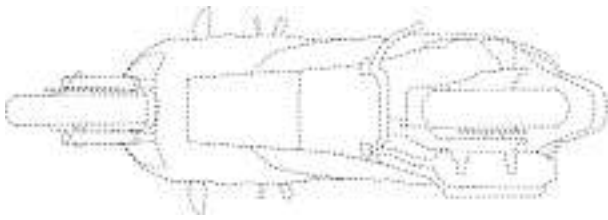

1

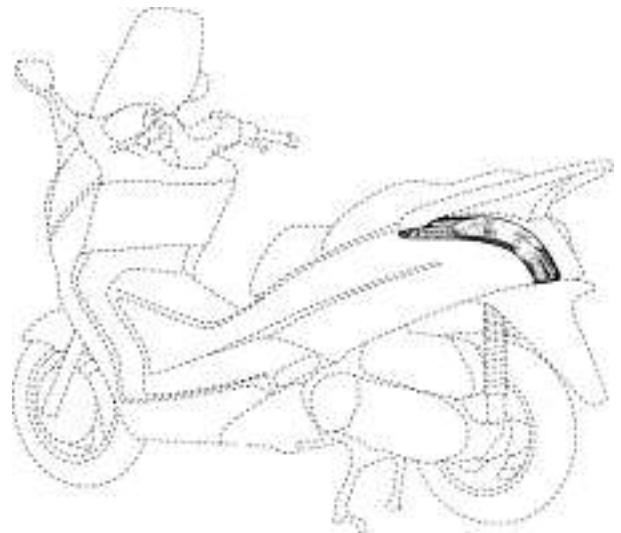
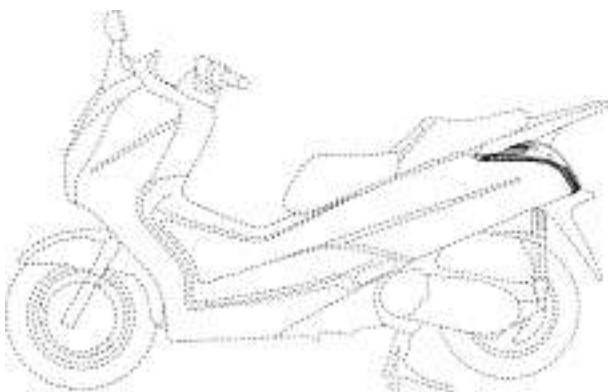

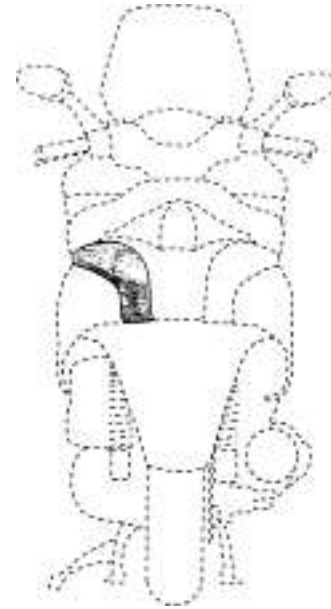
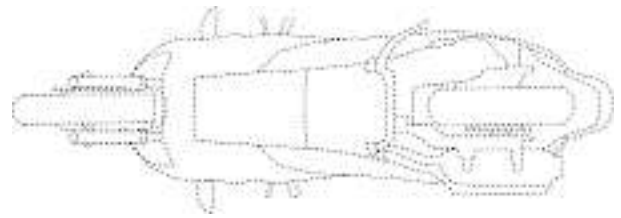
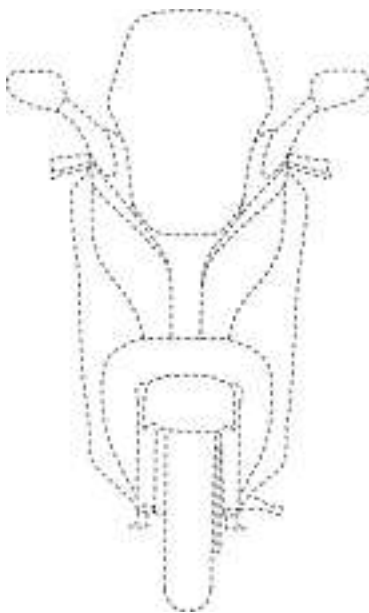
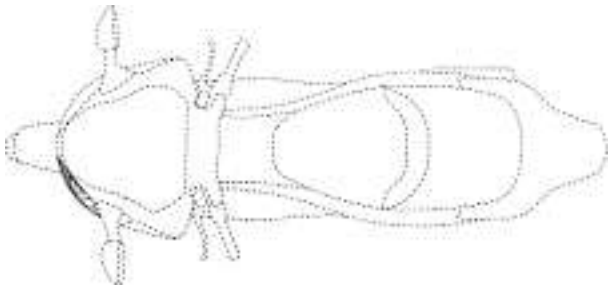
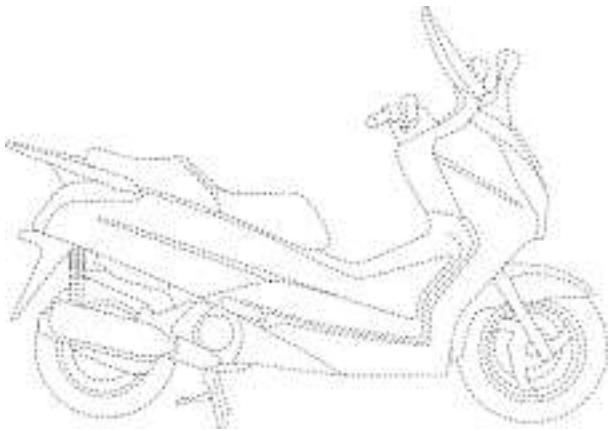
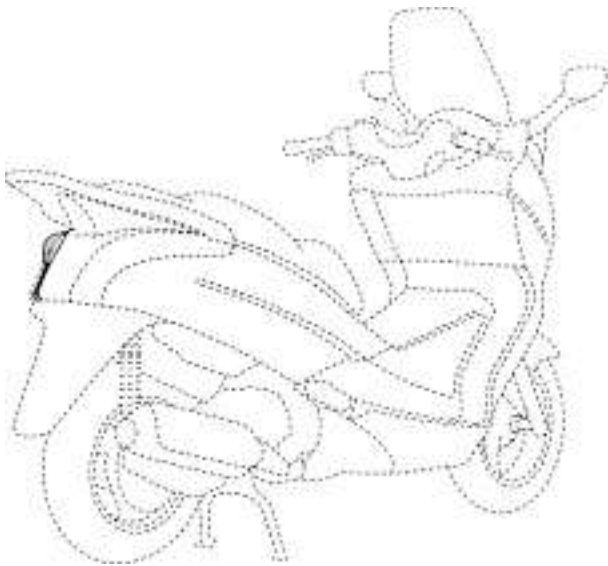

2

**Verlängerungen  
Prolongations  
Prolongazioni**

119 434 Cl. 04-02 2 design



1



1

119 786 Cl. 28-01 1 Design

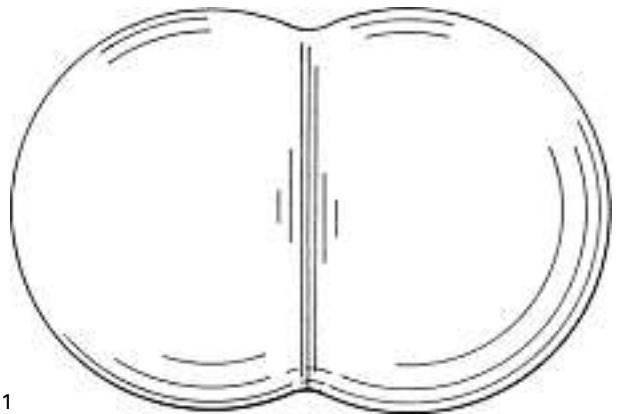
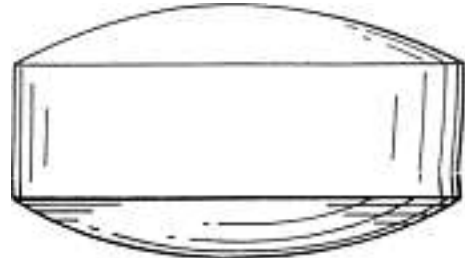
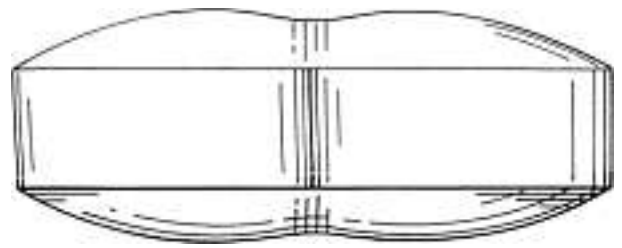
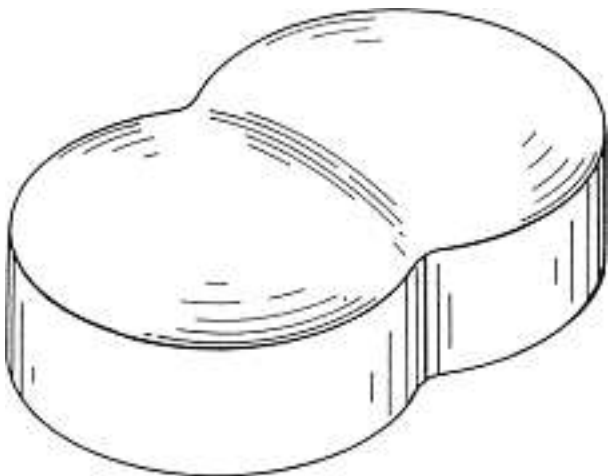

1

119 787 Cl. 04-02 8 Design

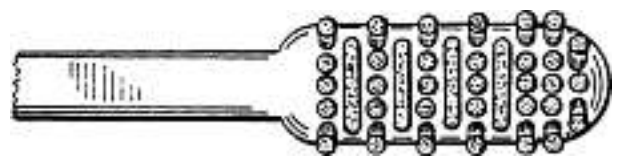

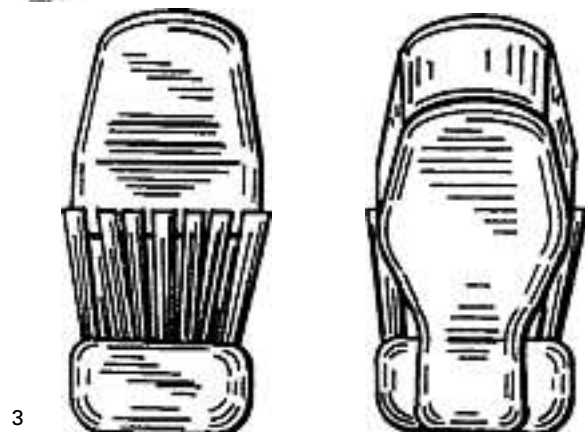
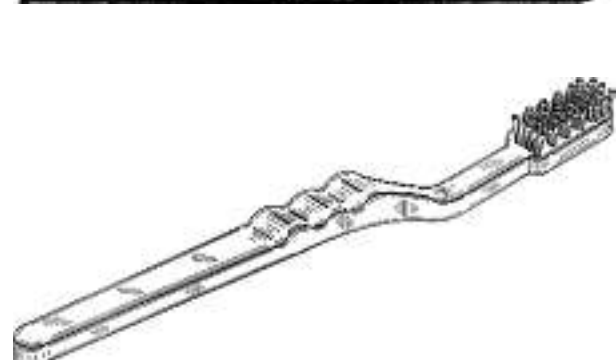
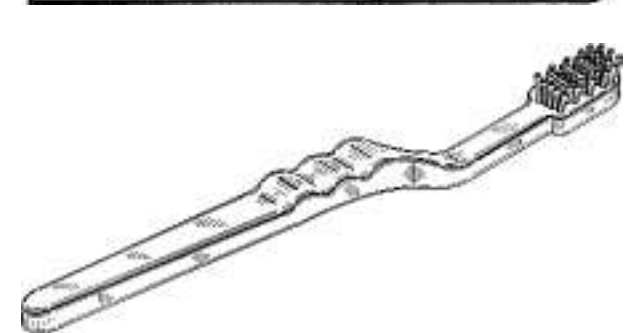
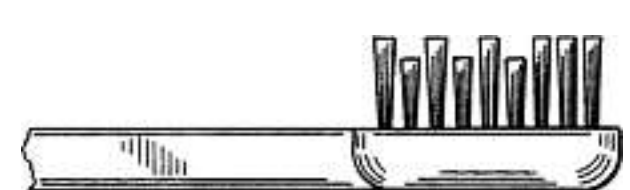
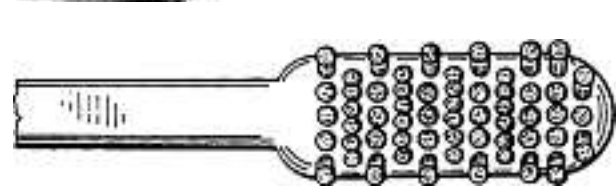
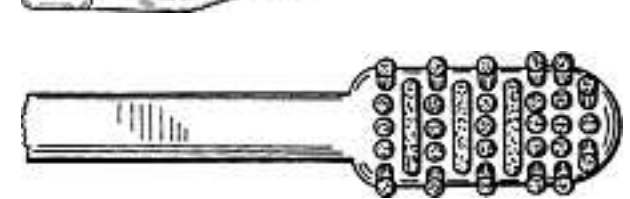
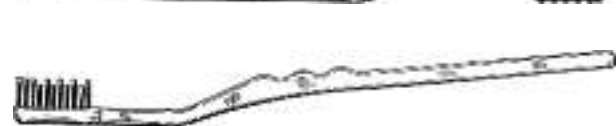
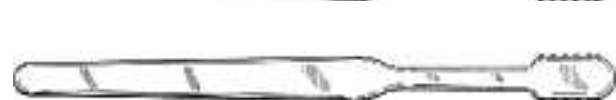
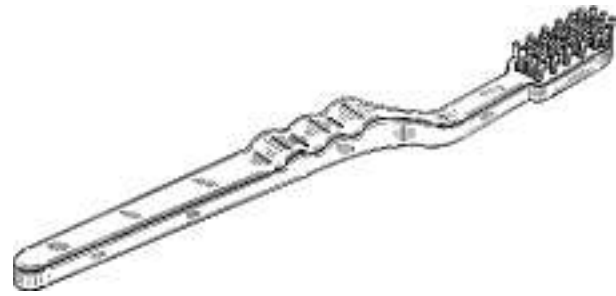
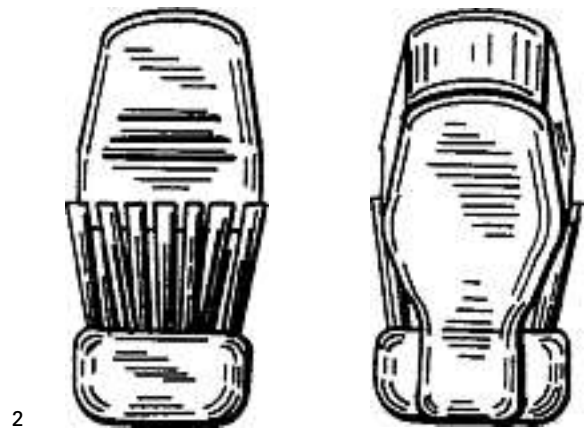
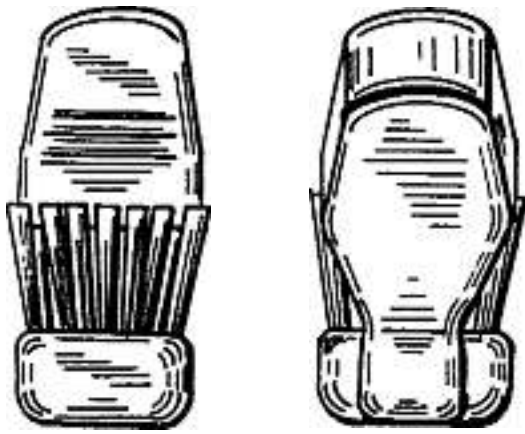

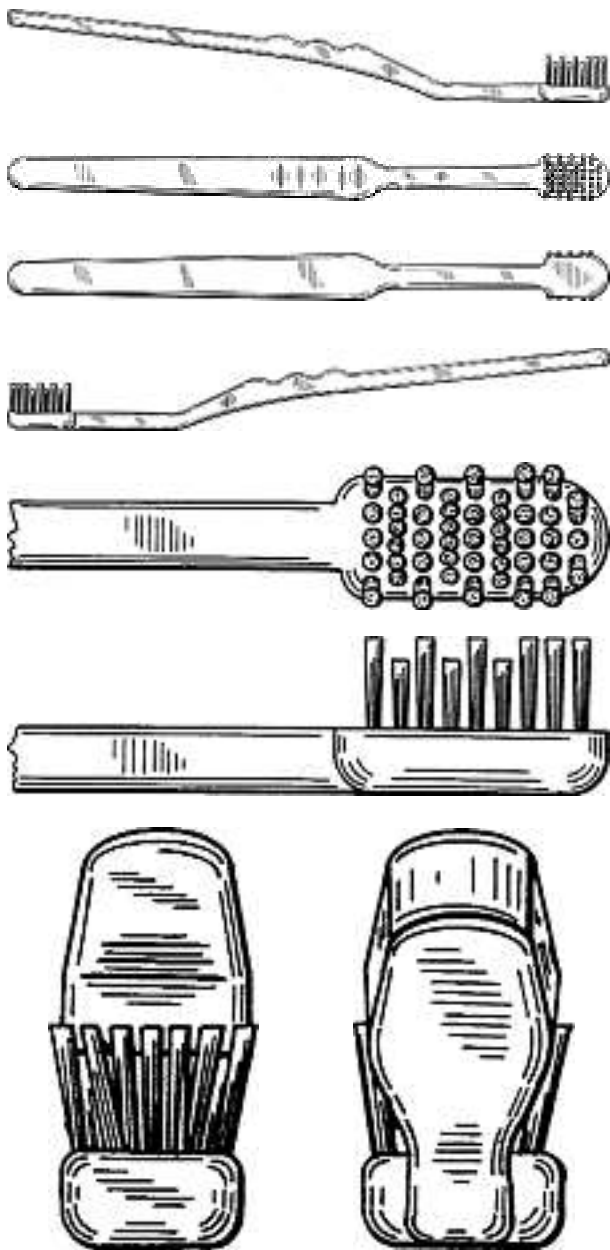

4

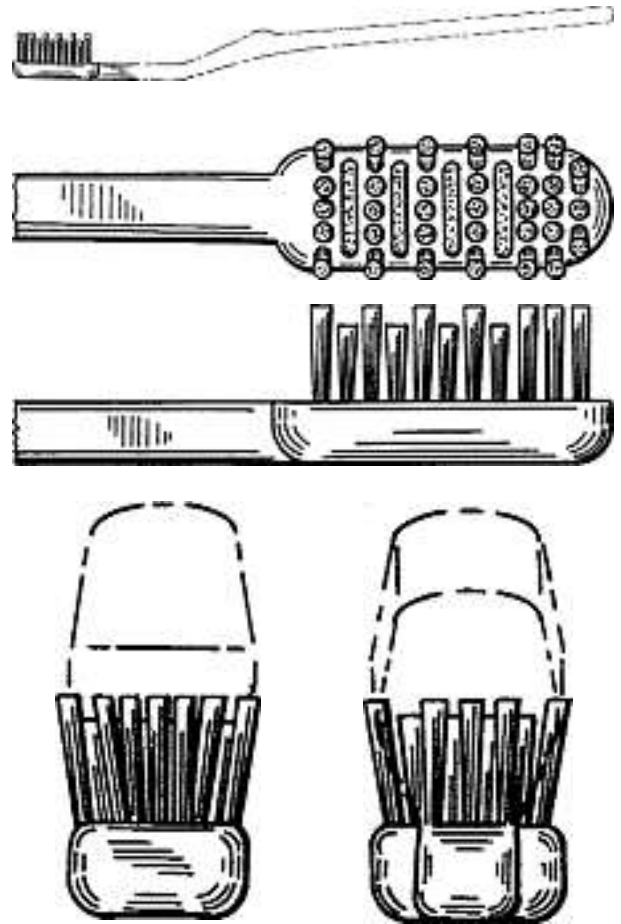
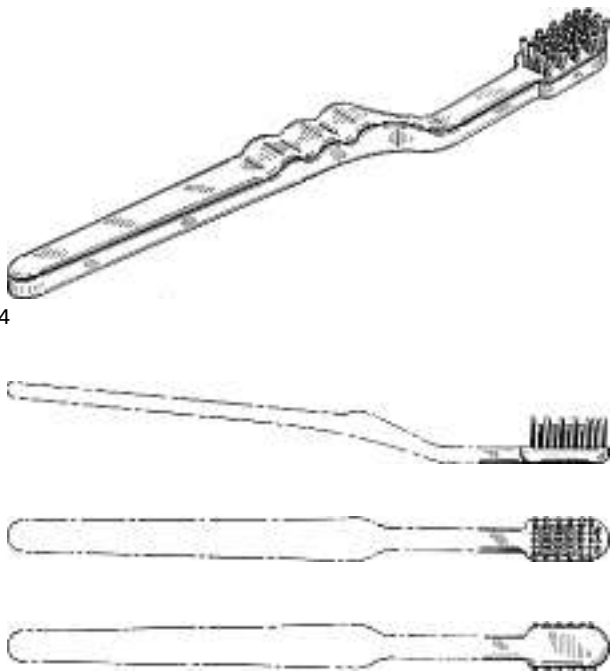

5

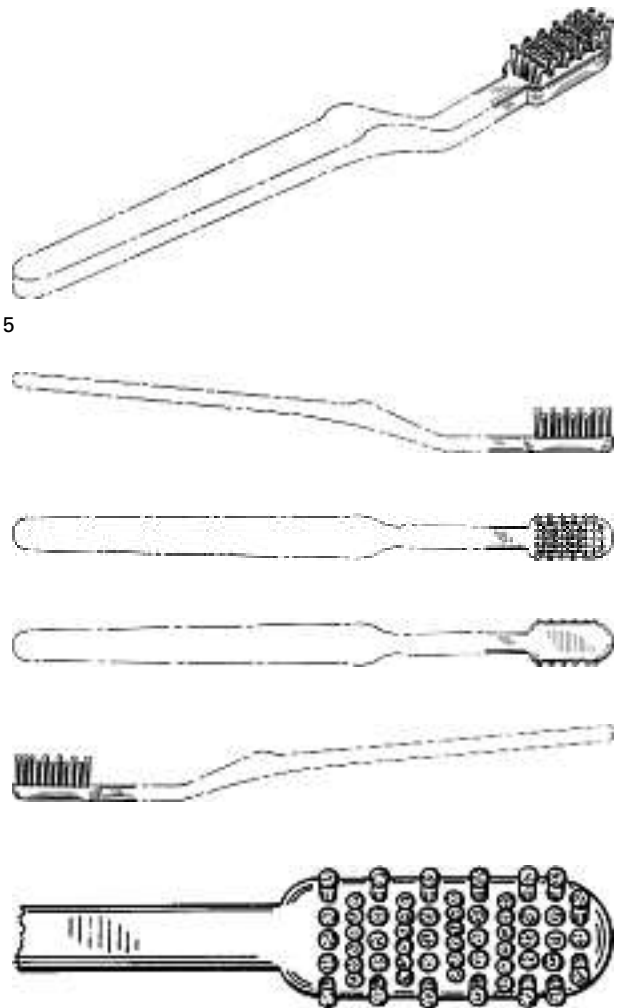



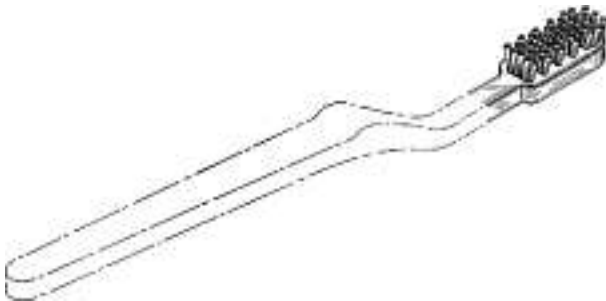
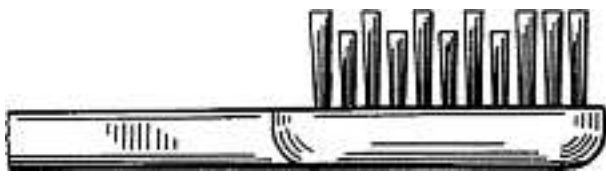

6

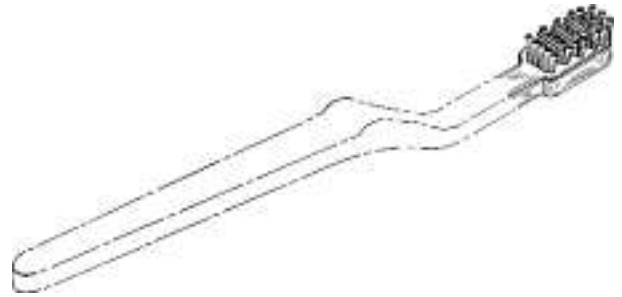
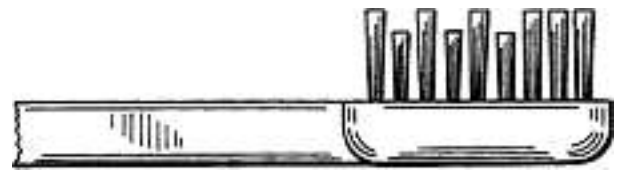
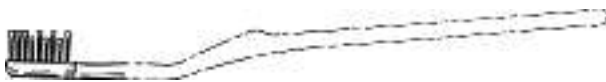

7

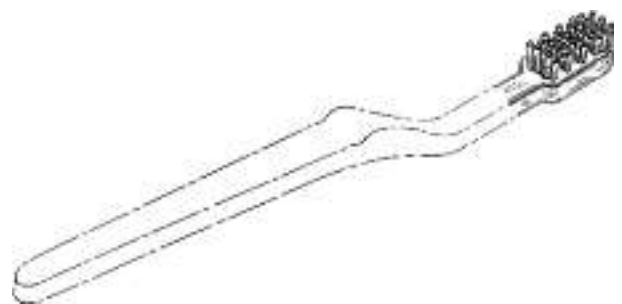
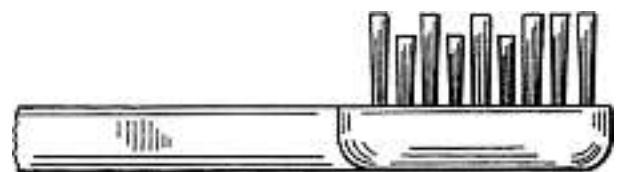
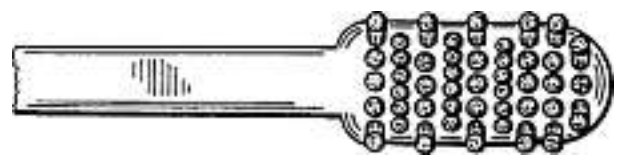



8

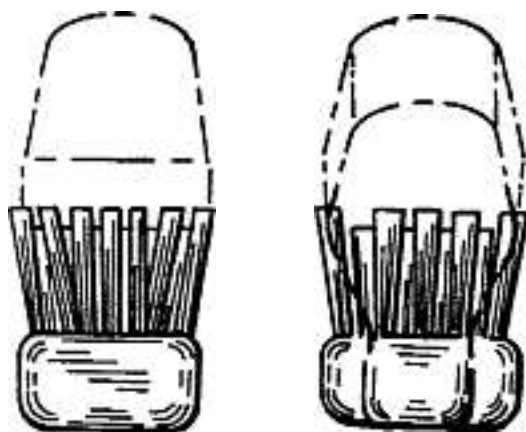

124 033	Cl.	06-06	10	design
124 044	Cl.	09-03	1	Design
124 115	Cl.	26-03	1	Design
124 138	Cl.	11-02	1	Design
124 172	Cl.	09-03	6	design
124 213	Cl.	09-02	1	design
124 214	Cl.	09-02	1	design
124 275	Cl.	06-01	3	Design
124 295	Cl.	11-03	1	Design
124 361	Cl.	26-05	72	design
124 376	Cl.	08-05	1	Design
128 669	Cl.	19-01	1	Design
128 670	Cl.	19-03	1	Design
128 683	Cl.	06-01	1	Design
128 699	Cl.	11-01	2	Design
128 717	Cl.	26-05	1	Design
128 719	Cl.	01-01	1	design
128 723	Cl.	03-01	1	Design
128 733	Cl.	12-11	1	Design
128 734	Cl.	14-02	1	Design
128 743	Cl.	06-01	5	Design
128 772	Cl.	21-01	2	Design
128 792	Cl.	06-99	4	Design
128 801	Cl.	14-01	4	Design
128 807	Cl.	24-02	1	Design
128 815	Cl.	05-06	1	design
128 834	Cl.	10-04	1	design
128 835	Cl.	10-04	1	design
128 839	Cl.	12-02	3	Design
128 842	Cl.	14-99	8	design
128 844	Cl.	19-08	1	design
128 891	Cl.	03-01	4	Design
128 935	Cl.	06-01	1	Design
128 942	Cl.	09-01	1	design
128 949	Cl.	11-01	2	Design
128 995	Cl.	06-04	3	Design
129 114	Cl.	19-06	4	design

## Löschungen Radiations Radiazioni

119 235	Cl.	06-01	3	Design
119 292	Cl.	09-03	1	design
119 301	Cl.	08-01	1	Design
123 585	Cl.	06-03	3	Design
123 614	Cl.	06-03	25	Design
123 619	Cl.	06-04	1	Design
123 620	Cl.	06-04	1	Design
123 638	Cl.	19-08	1	Design
123 642	Cl.	24-04	1	Design
123 661	Cl.	06-06	1	Design
123 664	Cl.	08-99	1	Design
123 670	Cl.	09-05	1	Design
128 235	Cl.	06-01	4	Design
128 239	Cl.	06-04	1	design
128 255	Cl.	11-01	16	Design
128 256	Cl.	11-02	1	Design
128 267	Cl.	26-05	2	Design
128 269	Cl.	02-02	12	Design
128 274	Cl.	06-04	65	Design
128 275	Cl.	06-04	18	Design
128 277	Cl.	06-06	3	Design
128 280	Cl.	08-05	1	design
128 287	Cl.	11-01	1	Design
128 291	Cl.	14-02	1	Design
128 293	Cl.	15-09	1	Design
128 295	Cl.	21-03	1	Design
128 298	Cl.	26-05	1	Design
128 299	Cl.	27-06	1	Design
128 303	Cl.	03-01	1	Design

Cl. 06-01 133 746 21.03.2007



D353363CH00

Cl. 08-07 133 754 19.03.2007



1

Cl. 09-05 133 762 20.03.2007



M13311/1



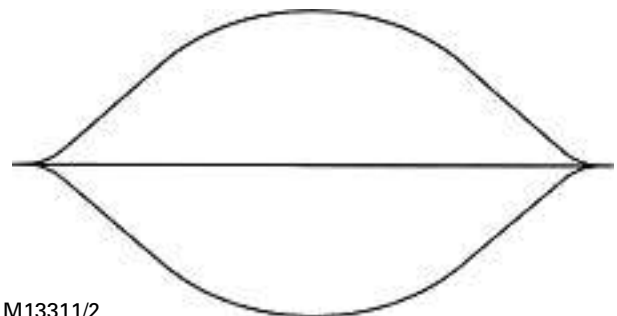
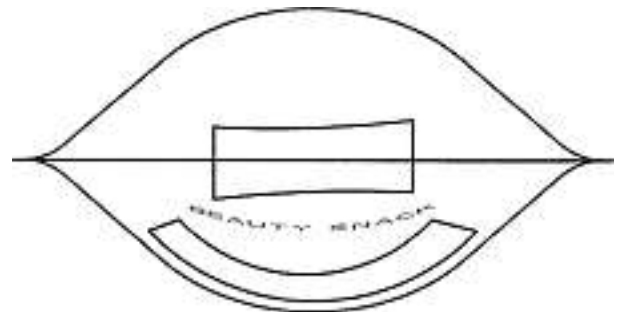
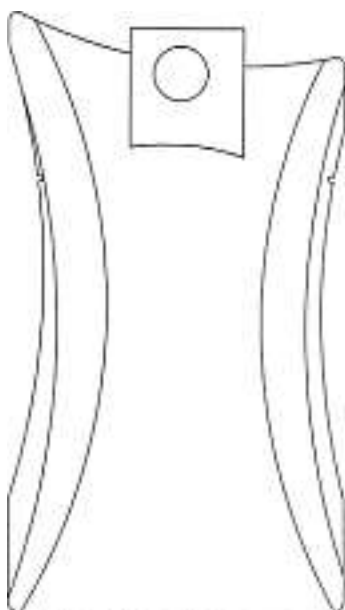
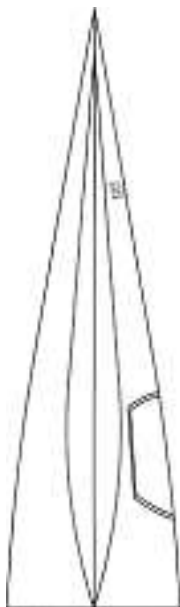

M13311/2

Cl. 10-02

133 764

03.01.2007

Bi ONE 080357



Cl. 10-02

133 767

04.04.2007



1

Cl. 10-07

133 769

30.03.2007



1



2



3



4



5







6



7

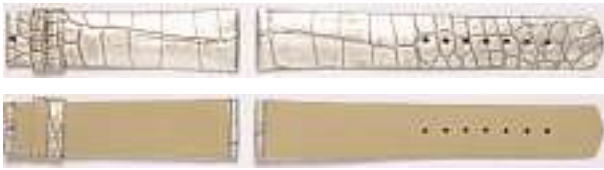

8

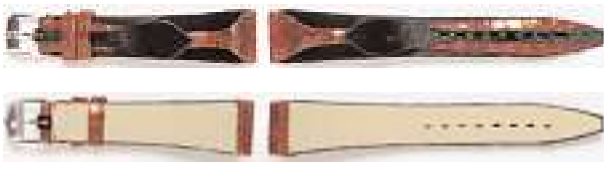

9



10



11



12



13



14



15



16



17



18



19



20



21

Cl. 11-01

133 771

05.03.2007



1



2





3



4







5



6







7



Cl. 11-01

133 772

26.03.2007



1



2

Cl. 11-01

133 773

28.03.2007





2



Cl. 15-09

133 780

15.03.2007





480/121 CH

Cl. 25-03

133 787

15.03.2007

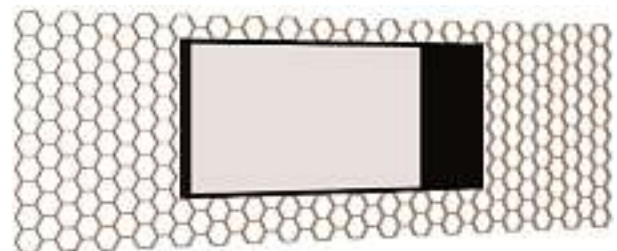
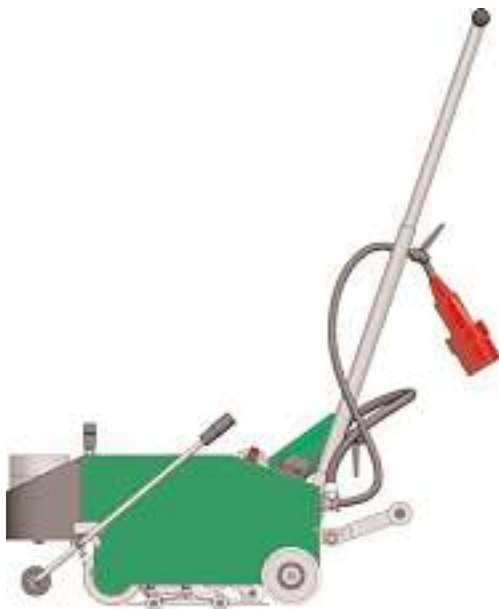

1





2



3

