

## Nationale Hinterlegungen

In der folgenden Liste werden die beim Eidgenössischen Institut für Geistiges Eigentum hinterlegten Designs publiziert. Dabei sind der Reihe nach angegeben:

- internationale Klassenangaben
- Hinterlegungsnummer
- Hinterlegungsdatum
- Allenfalls Aufschub der Veröffentlichung
- Anzahl der hinterlegten Designs
- Bezeichnung
- Name und Wohnsitz des Hinterlegers oder der Hinterlegerin
- gegebenenfalls Name und Wohnsitz des Designers oder der Designerin
- Name und Geschäftssitz des allfälligen Vertreters oder der Vertreterin
- gegebenenfalls Prioritätsangaben
- gegebenenfalls Beschreibungstext
- Ordnungsnummer
- Reproduktion des Designs

## Internationale Hinterlegungen

Die bei der Weltorganisation für geistiges Eigentum in Genf hinterlegten Muster und Modelle mit Benennung Schweiz geniessen den gleichen Schutz wie national hinterlegte Designs. Sie werden jeweils im Blatt «Bulletin des dessins et modèles internationaux» veröffentlicht. Dieses Publikationsorgan ist deshalb für eine vollständige Recherche unbedingt beizuziehen.

## Topographien

Angaben über die vom Eidgenössischen Institut für Geistiges Eigentum eingetragenen Topographien von Halbleitererzeugnissen werden in folgender Anordnung aufgeführt:

- Eintragsnummer
- Anmeldedatum
- Bezeichnung
- Name und Wohnsitz des Anmelders oder der Anmelderin
- gegebenenfalls Name und Wohnsitz des Herstellers oder der Herstellerin
- Name und Geschäftssitz des oder der allfälligen Bevollmächtigten
- Datum und Ort einer allfälligen ersten geschäftlichen Verbreitung der Topographie

## Dépôts nationaux

Les designs déposés à l'Institut Fédéral de la Propriété Intellectuelle sont publiés dans la liste qui suit. Les indications y relatives sont mentionnées dans cet ordre:

- indications des classes internationales
- numéro de dépôt
- date de dépôt
- le cas échéant, ajournement de la publication
- nombre des designs déposés
- désignation
- nom et domicile du/de la déposant/e
- le cas échéant, nom et domicile du/de la designer
- nom et domicile de l'éventuel/le mandataire
- le cas échéant, indication de priorité
- le cas échéant, description du design
- numéro attribué à chaque design
- reproduction du design

## Dépôts internationaux

Les dessins et modèles déposés à l'Organisation Mondiale de la Propriété Intellectuelle à Genève qui désignent la Suisse jouissent de la même protection que les dépôts nationaux. Ils sont chaque fois publiés dans la feuille «Bulletin des dessins et modèles internationaux». Pour une recherche complète, il est indispensable de consulter ledit organe de publication.

## Topographies

Les indications concernant les topographies des produits semi-conducteurs, enregistrées par l'Institut Fédéral de la Propriété Intellectuelle, sont énumérées dans l'ordre suivant:

- numéro d'enregistrement
- date de dépôt
- désignation
- nom et domicile du/de la déposant/e
- le cas échéant, nom et domicile du/de la producteur/trice
- nom et domicile de l'éventuel/le mandataire
- date et lieu d'une éventuelle première mise en circulation de la topographie

## Depositi nazionali

Nella lista seguente vengono pubblicati i design depositati presso l'Istituto Federale della Proprietà Intellettuale. Sono menzionati nel seguente ordine:

- indicazioni delle classi internazionali
- numero di deposito
- data del deposito
- se del caso, indicazione che la pubblicazione è stata differita
- numero dei design depositati
- designazione
- nome e domicilio del depositante
- se del caso, nome e domicilio del designer
- nome e sede di un eventuale mandatarario
- se del caso, indicazioni di priorità
- se del caso, descrizione del design
- numero d'ordine
- riproduzione del design

## Depositi internazionali

I disegni e modelli depositati presso l'Organizzazione Mondiale della Proprietà Intellettuale a Ginevra con denominazione Svizzera godono della medesima protezione del deposito nazionale. Essi vengono pubblicati ogni volta nel foglio «Bulletin des dessins et modèles internationaux». Quest'organo di pubblicazione è da consultare se si vuole effettuare una ricerca completa.

## Topografie

Le indicazioni concernenti le topografie di prodotti a semiconduttori depositati presso l'Istituto Federale della Proprietà Intellettuale sono menzionate nell'ordine seguente:

- numero di registrazione
- data del deposito
- designazione
- nome e domicilio del/la richiedente
- se del caso, nome e domicilio del/la produttore/trice
- nome e sede di un eventuale mandatarario
- data e luogo di un'eventuale prima messa in circolazione della topografia

## Hinterlegungen Dépôts Deposit

Cl. 09-03 130 942 25.08.2004  
1 Design – Verpackung  
Hinterleger: Marie Kehl Moundalek, Kleindorfstrasse 12h,  
8707 Uetikon am See

Ende aufgeschobene Publikation

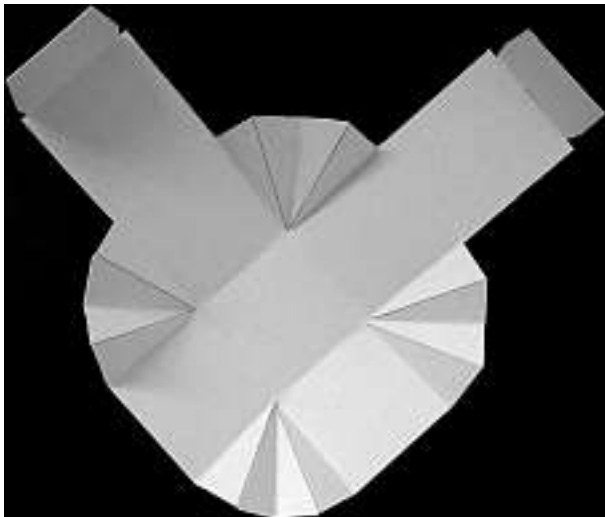
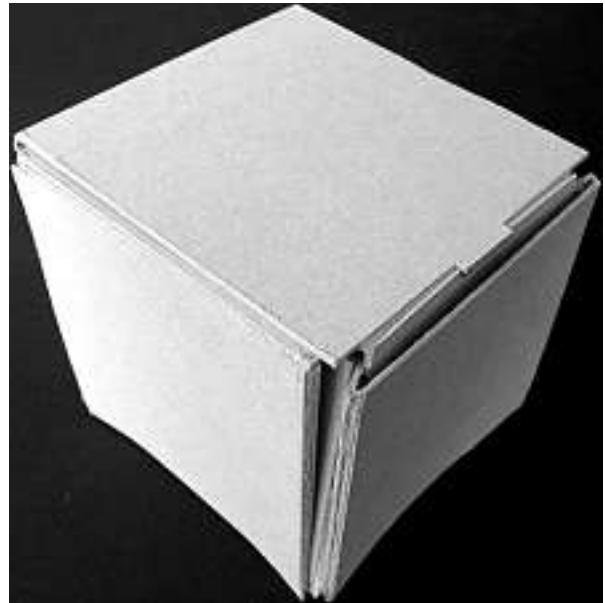
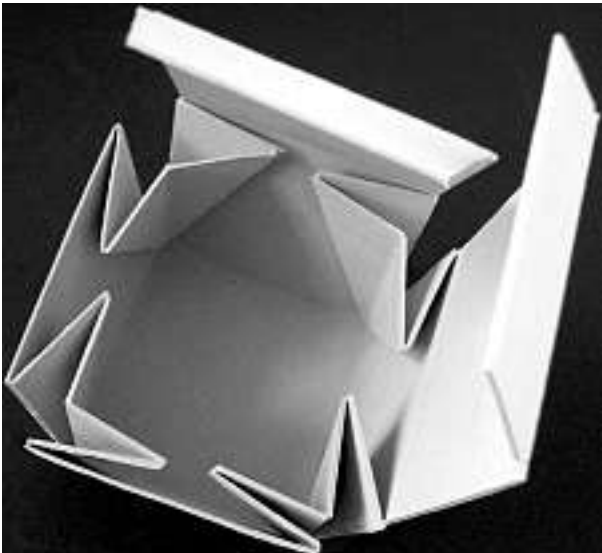

0880

Cl. 25-03 131 057 31.08.2004  
1 Design – Restaurant/Bar  
Hinterleger: Ines Lüthi, Talstrasse 115, 3174 Thörishaus

Ende aufgeschobene Publikation

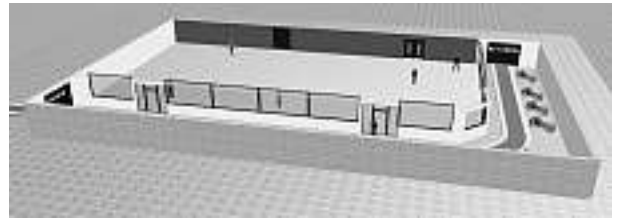
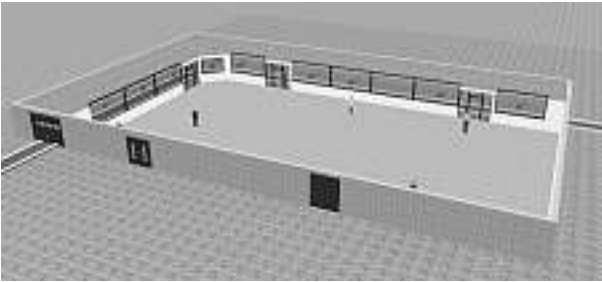
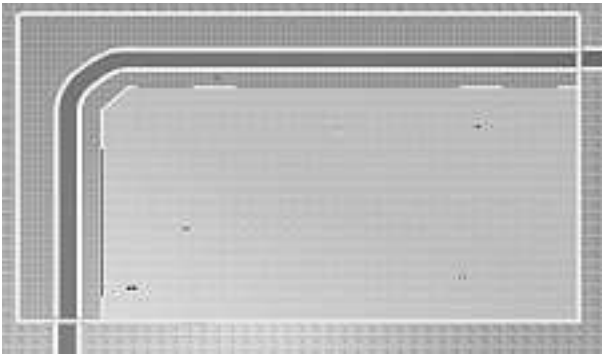

1

Cl. 20-02 131 098 14.09.2004  
1 Design – Steller  
Hinterleger: Bruno Messerli, Hauptstrasse 106, Brittern,  
4587 Aetingen

Ende aufgeschobene Publikation





Theke

Cl. 20-02 131 099 14.09.2004  
1 Design – Steller  
Hinterleger: Bruno Messerli, Hauptstrasse 106, Brittern,  
4587 Aetingen  
Ende aufgeschobene Publikation



POS

Cl. 20-02 131 100 14.09.2004  
1 Design – Steller  
Hinterleger: Bruno Messerli, Hauptstrasse 106, Brittern,  
4587 Aetingen

Ende aufgeschobene Publikation



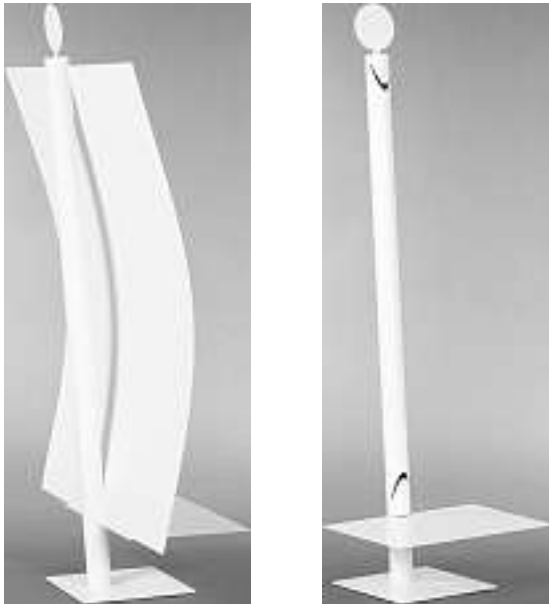

Fenster

Cl. 10-02 131 420 17.02.2005  
 2 design – montre bracelet  
 Déposant: Eduardo Oria Feliu, Urbanizacion Cerrado de Elviria, Avenida de las Cubres No 1, Marbella (Malaga), ES  
 Mandataire: Micheli & Cie, 1226 Thônex (Genève)

Fin de la période ajournement de la publication

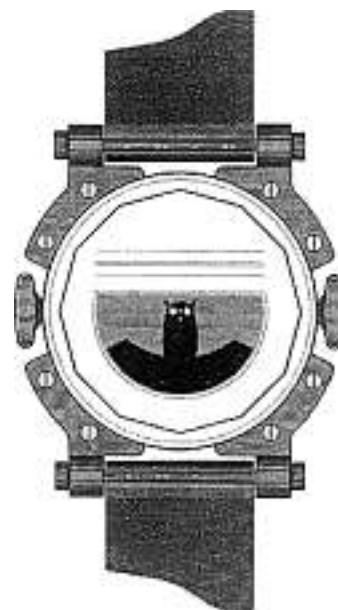
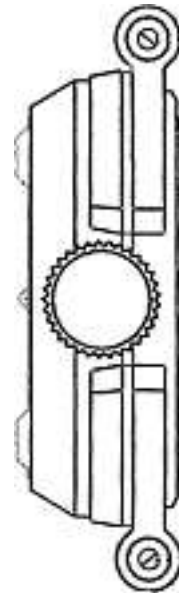

14426A

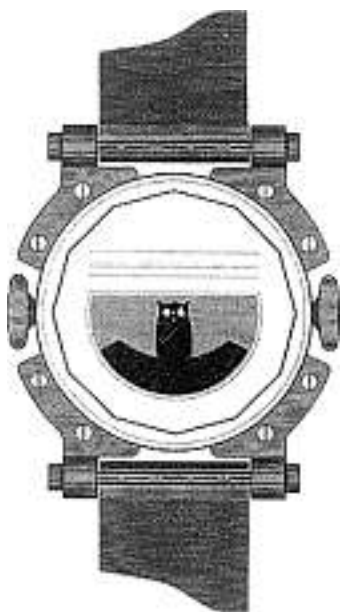
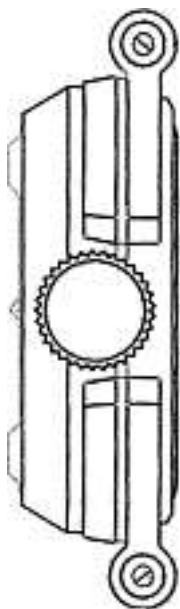

Cl. 10-07 **131 764** 09.05.2005  
 1 design – bracelet de montre  
 Déposant: Movado Watch Company S.A., Bettlachstrasse 8,  
 2540 Grenchen  
 Designer: Florian Strasser, Meisberg  
 Mandataire: Micheli & Cie, 1226 Thônex (Genève)  
 Priorité: US, 10.11.2004

Fin de la période ajournement de la publication

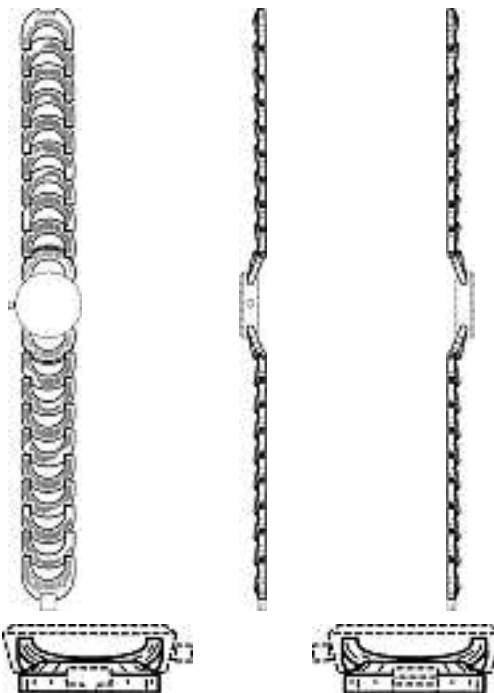

14478A

Cl. 10-07 **131 765** 12.05.2005  
 1 design – boîte de montre  
 Déposant: Movado Watch Company S.A., Bettlachstrasse 8,  
 2540 Grenchen  
 Designer: Florian Strasser, Meisberg  
 Mandataire: Micheli & Cie, 1226 Thônex (Genève)  
 Priorité: US, 19.11.2004

Fin de la période ajournement de la publication



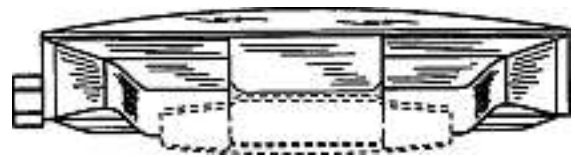
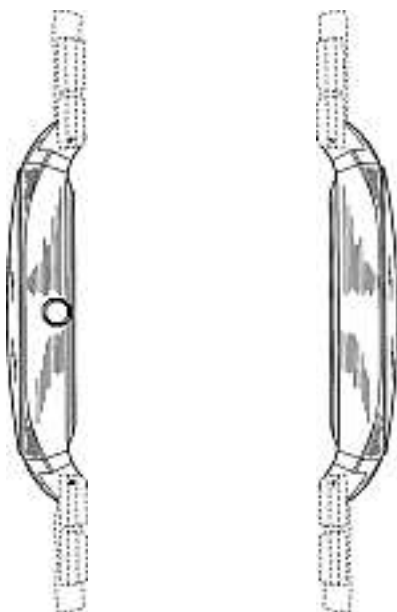

14479a

Cl. 10-07 132 360 24.11.2005

1 design – montre

Déposant: MB & F SA, chemin de Grange-Canal 35,  
1223 Coligny

Designer: Eric Giroud, Genève

Mandataire: Inteltech SA, 2001 Neuchâtel

Fin de la période ajournement de la publication





1

Cl. 09-01                      **132 780**                      22.05.2006  
 2 design – bouteille  
 Déposant: Sanpellegrino S.p.A., Via Castelvetro 17/23,  
 Milano, IT  
 Designer: Fabio Chimetto, Piazzola sul Brenta  
 Mandataire: Nestec S.A., 1800 Vevey  
 Priorité: EM, 30.11.2005

Fin de la période ajournement de la publication

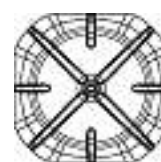
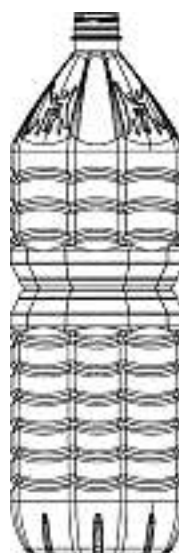
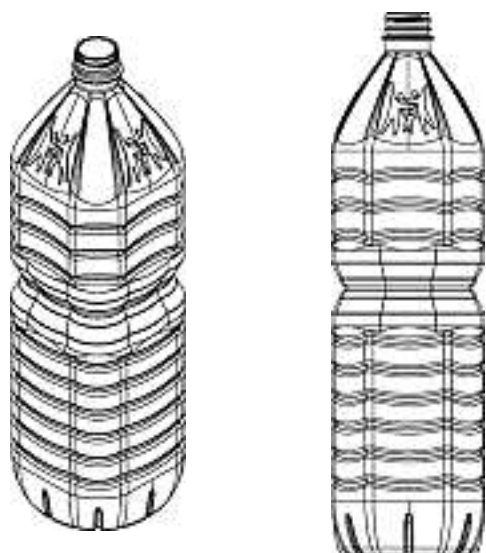

1

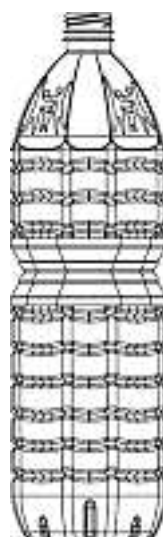
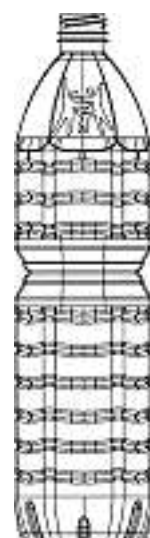
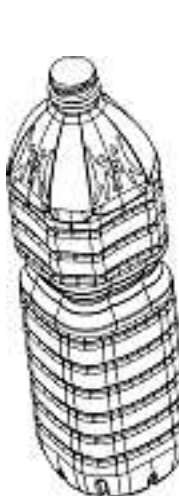
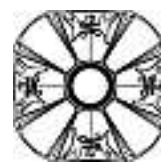

2

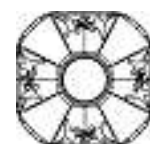

Cl. 10-02                      **132 888**                      21.06.2006  
 3 design – montres-bracelets  
 Déposant: Luxury Timepieces International SA,  
 Ch. des Rochettes 2, 2016 Cortaillod  
 Designer: Dino Modolo, La Chaux-de-Fonds  
 Mandataire: Inteltech SA, 2001 Neuchâtel

Fin de la période ajournement de la publication





1





Cl. 10-07 133 240 30.10.2006  
1 design – montre  
Déposant: Eric Giroud, 19, rue du 31-Décembre, 1207 Genève  
Mandataire: Inteltech SA, 2001 Neuchâtel

Fin de la période ajournement de la publication





Cl. 10-02 **133 395** 28.11.2006

2 design – montres-bracelets

Déposant: Luxury Timepieces International SA,  
Ch. des Rochettes 2, 2016 Cortaillod

Designer: Dino Modolo, La Chaux-de-Fonds

Mandataire: Inteltech SA, 2000 Neuchâtel

Fin de la période ajournement de la publication



1





2

Cl. 10-02, 10-07 **133 531** 24.01.2007  
 3 design – boîte de montre avec bracelet, bracelet de montre  
 et fermoir, montre-bracelet  
 Déposant: Promomark SA, 2, route de Moncor,  
 1752 Villars-sur-Glâne  
 Designer: Alain Mouawad, Genève  
 Mandataire: Inteltech SA, 2001 Neuchâtel

Fin de la période ajournement de la publication



1

2



3

Cl. 01-01 **133 616** 22.01.2007  
 1 design – chocolats  
 Déposant: Société des Produits Nestlé SA, 1800 Vevey  
 Designer: Daniel Magnin, York  
 Mandataire: Nestec S.A., 1800 Vevey

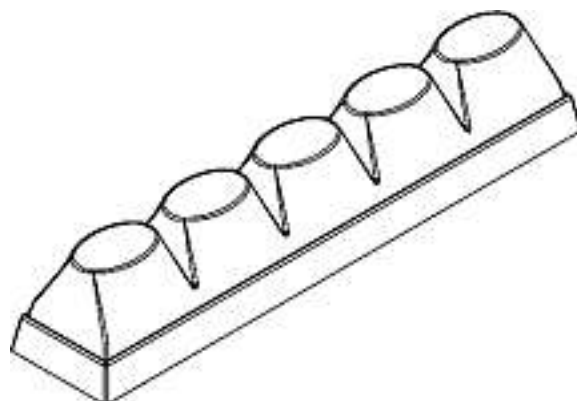

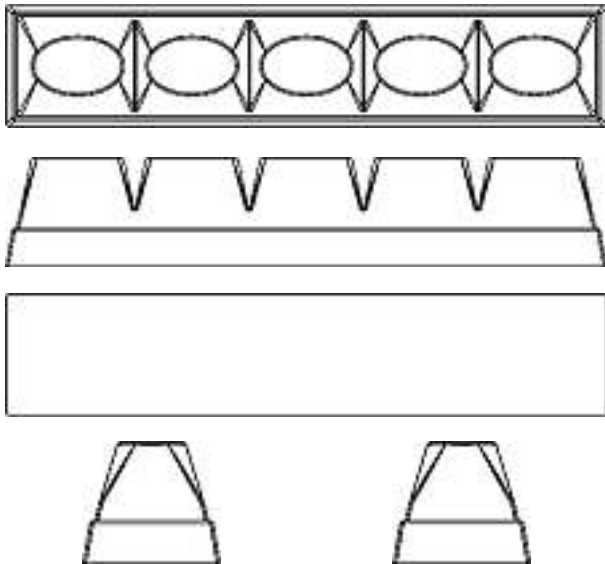

FL 64078

Cl. 02-03 133 617 29.12.2006  
2 design – casquette  
Déposant: Henri Bassi, Chemin du Levant 143,  
1005 Lausanne



1





2

Cl. 06-01                      **133 618**                      30.12.2006  
 5 Design – Polstermöbel  
 Hinterleger: Intertime AG, Polstermöbelfabrik,  
 Brühlstrasse 21, 5304 Endingen  
 Designer: Johannes Weibel, Untersiggenthal



2701.1



2701.2



2704



2708.1



2708.2

Cl. 06-01                      **133 619**                      30.12.2006  
 1 Design – Sessel  
 Hinterleger: Intertime AG, Polstermöbelfabrik,  
 Brühlstrasse 21, 5304 Endingen  
 Designer: Louis Schneider, Lengnau



2737

Cl. 06-01 133 620 30.12.2006  
 2 Design – Polstermöbel  
 Hinterleger: Intertime AG, Polstermöbelfabrik,  
 Brühlstrasse 21, 5304 Endingen  
 Designer: Matthias Weber, Zürich



2797.1



2797.2

Cl. 06-01, 06-03, 06-06 133 621 16.01.2007  
 9 design – chaises, tables et parties de meubles  
 Déposant: Bonaldo SpA, Via Straelle 3,  
 Villanova di Camposampiero (Padova), IT  
 Designer: Stefan Heiliger, Frankfurt; Claudio Dondoli,  
 Colle Val d'Elsa; Mauro Lipparini, Firenze  
 Mandataire: Jacobacci & Partners S.A., 1207 Genève  
 Priorité: EM, 31.07.2006







D-2037/07-S1



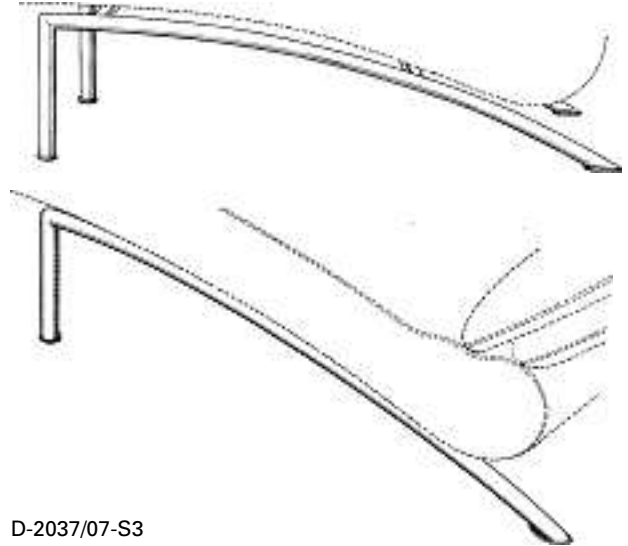

D-2037/07-S3



D-2037/07-S2



D-2037/07-S4

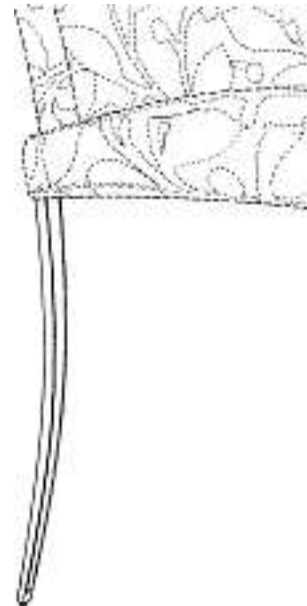

D-2037/07-S5



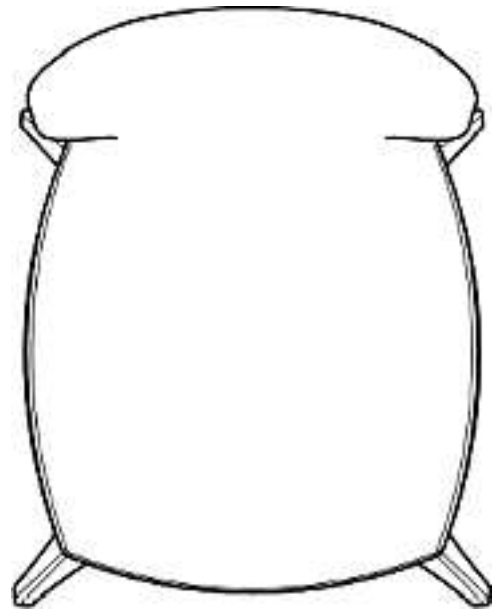
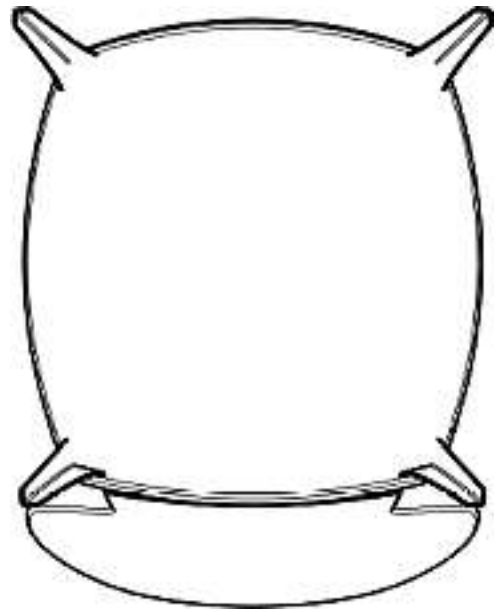

D-2037/07-S6





D-2037/07-S8



D-2037/07-S7

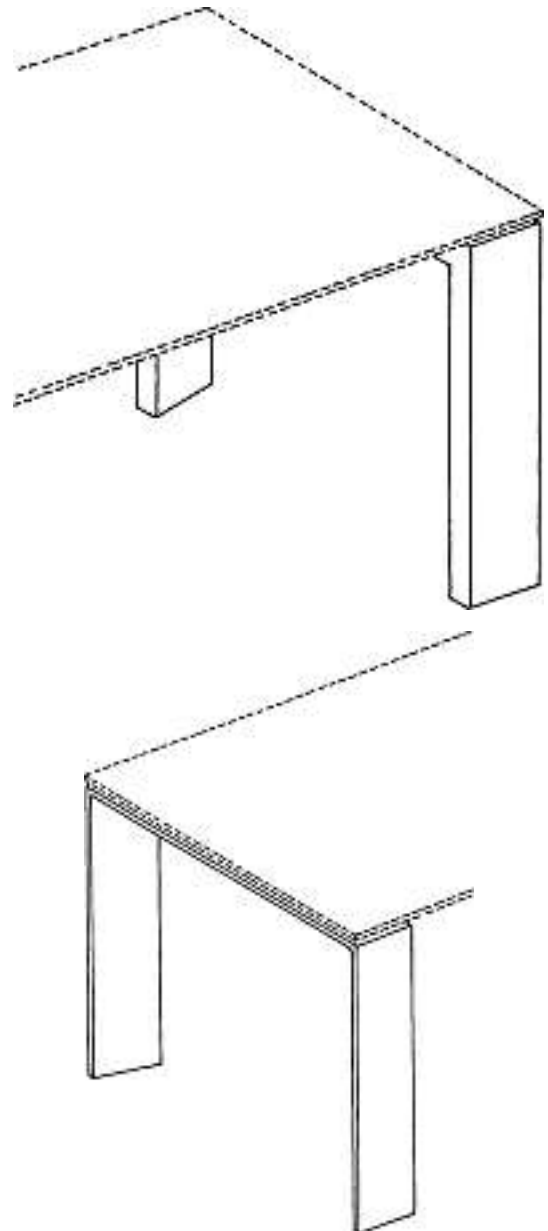

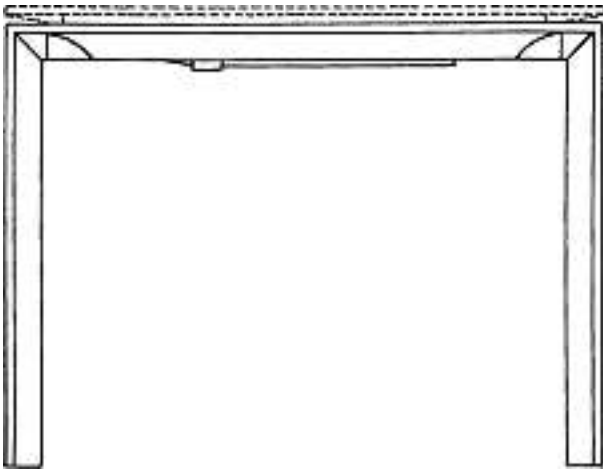

D-2037/07-S9

Cl. 06-01, 06-03,  
06-04, 06-06 **133 622** 25.01.2007  
47 design – banquettes, poufs, chaises, canapés,  
méridiennes, éléments de meubles, fauteuils, tables, siège  
Déposant: Double You Meubelcollectie B.V.,  
Minervum 7388-7390, ZH Breda, NL  
Designer: Sako Wijma, Vuren  
Mandataire: William Blanc & Cie, Conseils en Propriété  
Industrielle S.A., 1220 Les Avanchets/Genève



1



2



3



4



5



6



7



8



9



10



11



12



13



14



15



19



16



20



17

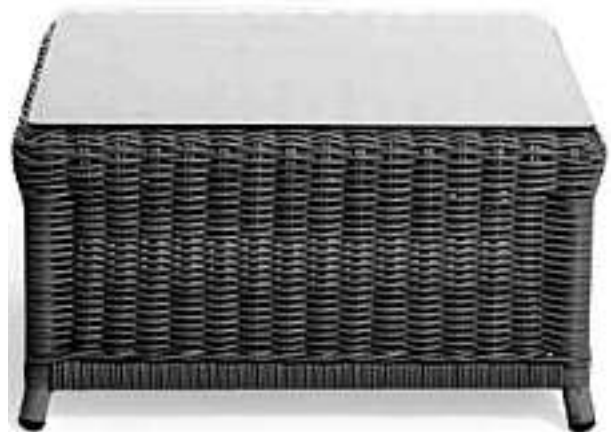

21



18



22





23



24



25



26



27



28



29



30



31



32



33



37



34



38



35



39



36



40



44



41



45



42

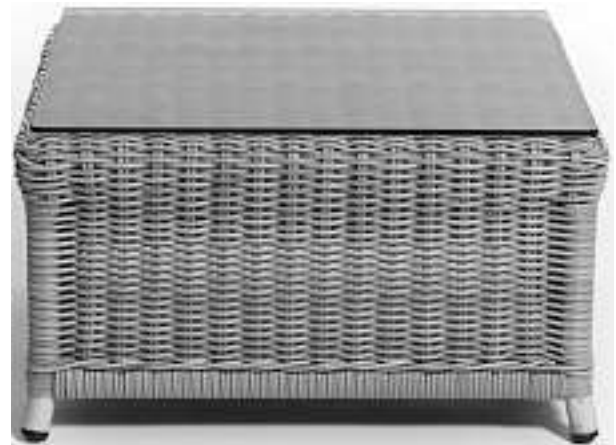

46



43



47

Cl. 06-01 133 623 20.02.2007  
 2 Design – Treppenhochstuhl  
 Hinterleger: Flück Werke AG, Hauptstrasse 302,  
 3855 Brienz BE  
 Designer: Bernhard Flück, Brienz  
 Vertreter: Bovard AG, 3000 Bern 25



1



2

Cl. 06-03, 06-04 133 624 12.01.2007  
 4 Design – Tisch, Sideboard  
 Hinterleger: Mobimex AG, Birren 19, 5703 Seon  
 Designer: Dante Bonuccelli, Milano



IXO-Tisch mit Gitteruntergestell



IXO-Sideboard



IXO-Mediaboard



IXO-Konsole

Cl. 06-04                      **133 625**                      31.01.2007  
 1 Design – Sideboard  
 Hinterleger: Nicole Knüsel-Ettlin, Schäferstrasse 12, 4125 Riehen;  
 Stefan Knüsel-Ettlin, Schäferstrasse 12, 4125 Riehen  
 Vertreter: Stefan Knüsel-Ettlin, 4125 Riehen



1

Cl. 07-01                      **133 626**                      30.11.2006  
 2 Design – Teetasse und Untertasse  
 Hinterleger: Dr. Dünner AG, Artherstrasse 60, 6405 Immensee  
 Designer: Georg-Ludwig Mylius, Rosenheim  
 Vertreter: Hepp Wenger Ryffel AG, 9500 Wil SG

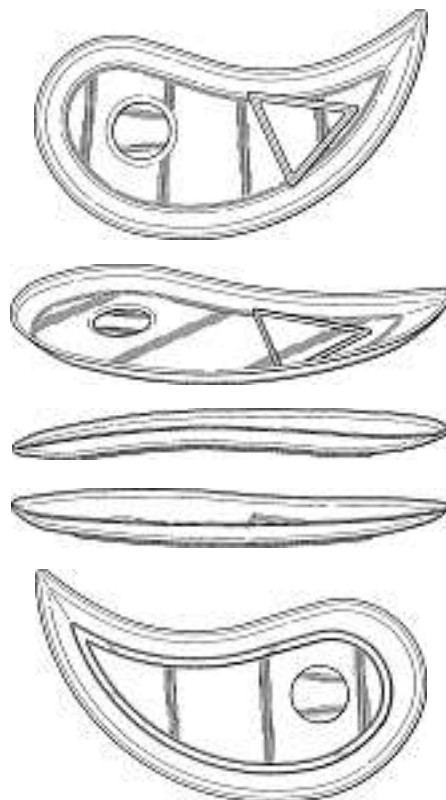

MDDN001CH1-8 1



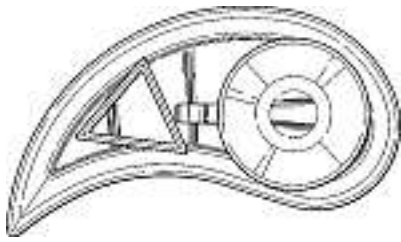

MDDN001CH1-8 2

Cl. 07-01 133 627 22.01.2007  
2 Design – Getränkekrug  
Hinterleger: PI-DESIGN AG, Kantonsstrasse 100,  
6234 Triengen  
Designer: Jorgen Bodum, St. Niklausen  
Vertreter: Isler & Pedrazzini AG, 8023 Zürich  
Priorität: DK, 17.08.2006





M13292-1

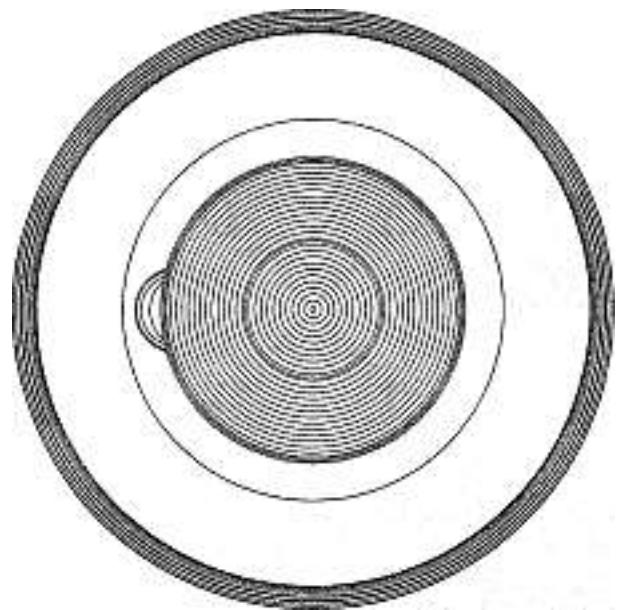
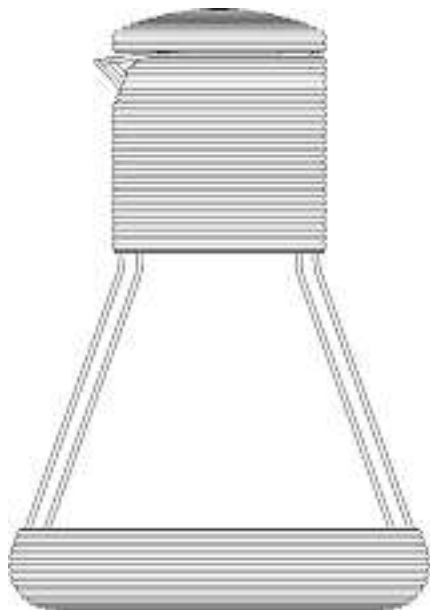
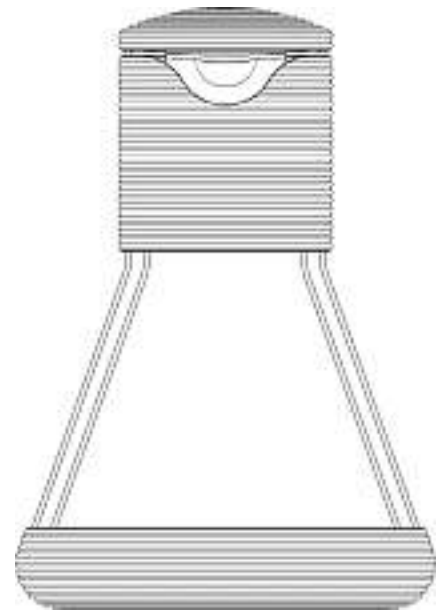
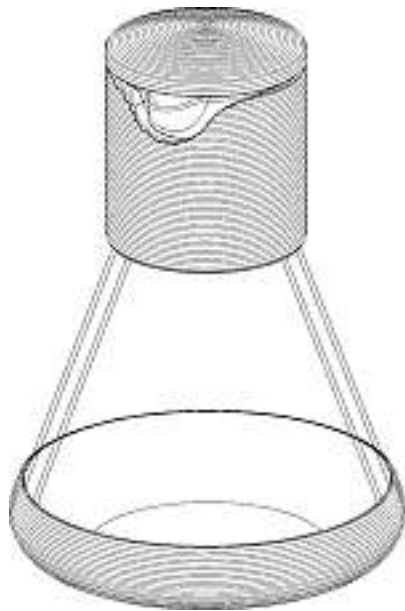
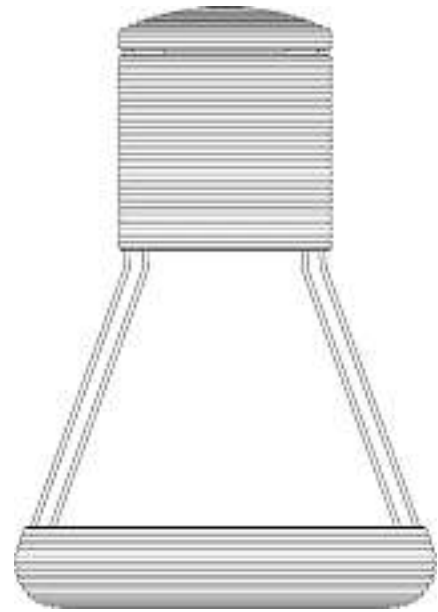

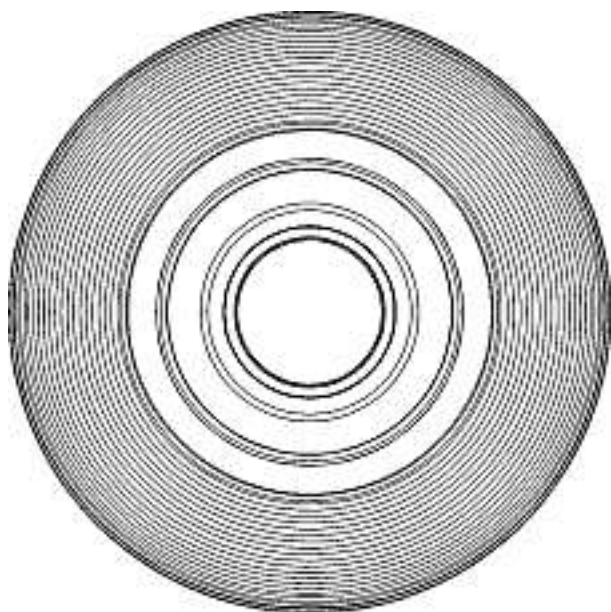

M13292-2



M13293

Cl. 07-01                      **133 628**                      29.01.2007  
 1 Design – Trinkglas  
 Hinterleger: PI-DESIGN AG, Kantonsstrasse 100,  
 6234 Triengen  
 Designer: Jorgen Bodum, St. Niklausen  
 Vertreter: Isler & Pedrazzini AG, 8023 Zürich  
 Priorität: DK, 17.08.2006



Cl. 07-02                      **133 630**                      01.02.2007  
 1 design – machine pour boissons  
 Déposant: Société des Produits Nestlé SA, 1800 Vevey  
 Designer: Florian Wassermann, Zürich; Therese Naef,  
 Wettingen; Britta Pukall, Männedorf; Peter Gutmann, Zürich;  
 Simone Gosteli, Seewen  
 Mandataire: Nestec S.A., 1800 Vevey





FL 64186

Cl. 07-02 **133 631** 01.02.2007

1 design – machine pour boissons

Déposant: Société des Produits Nestlé SA, 1800 Vevey  
 Designer: Florian Wassermann, Zürich; Therese Naef,  
 Wettingen; Britta Pukall, Männedorf; Peter Gutmann, Zürich;  
 Simone Gosteli, Seewen  
 Mandataire: Nestec S.A., 1800 Vevey



FL 64188

Cl. 08-05 **133 633** 24.01.2007

1 Design – Schraubenschlüssel

Hinterleger: Black & Decker, Inc., 1207 Drummond Plaza,  
 Newark/DE, US

Designer: Gregory Scott Snider, Bel Air  
 Vertreter: E. Blum & Co. AG, Patent- und  
 Markenanwälte VSP, 8044 Zürich

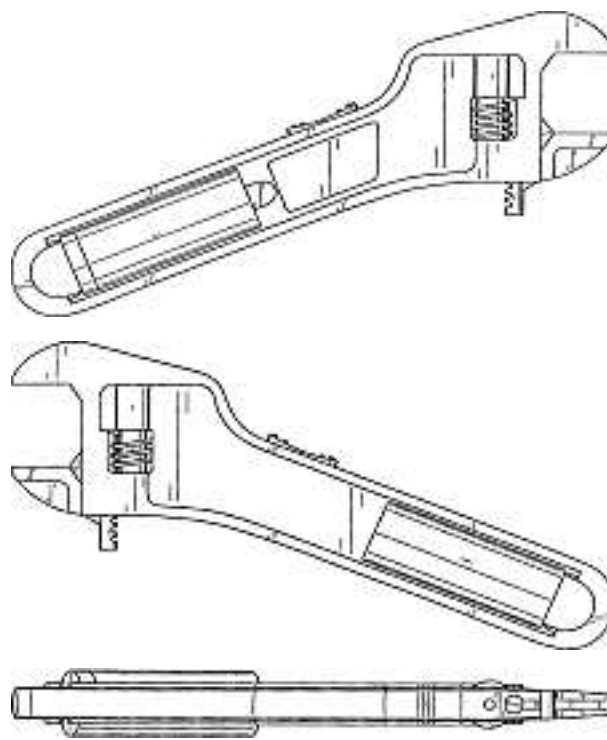
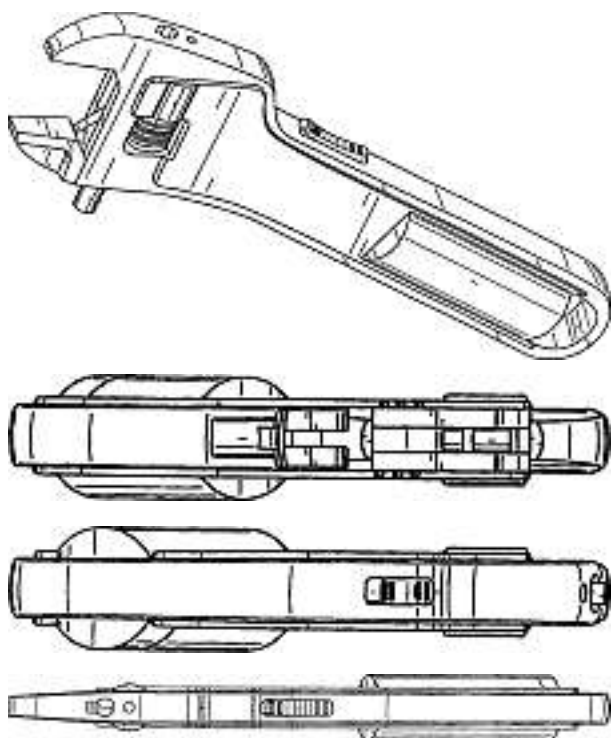

A-2007/1003

Cl. 09-01 **133 634** 24.11.2006

1 Design – Becher

Hinterleger: Albiplast AG, Marktstrasse 36, 9244 Niederuzwil  
 Designer: Dieter Veit, Altnau





Cl. 09-01 133 635 01.02.2007  
2 Design – Flasche  
Hinterleger: The Coca-Cola Company,  
One Coca-Cola Plaza N.W., Atlanta, GA, US  
Designer: Malcolm Kinmont, Atlanta; Yves Behar, Oakland  
Vertreter: Ritscher & Partner AG, 8702 Zollikon  
Priorität: US, 28.08.2006

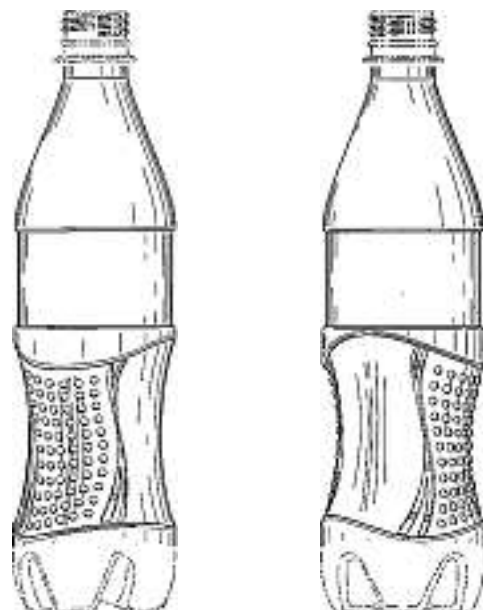
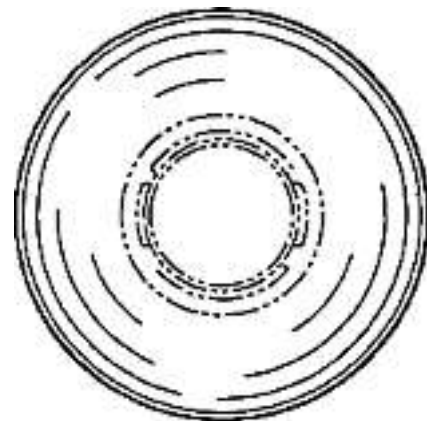

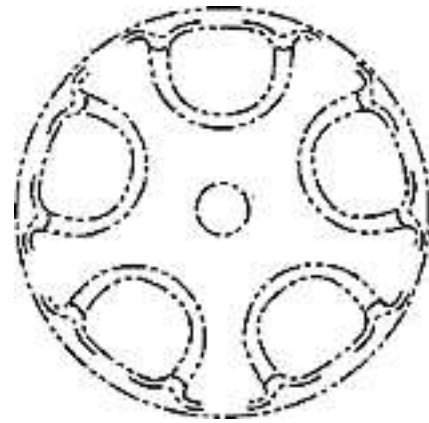
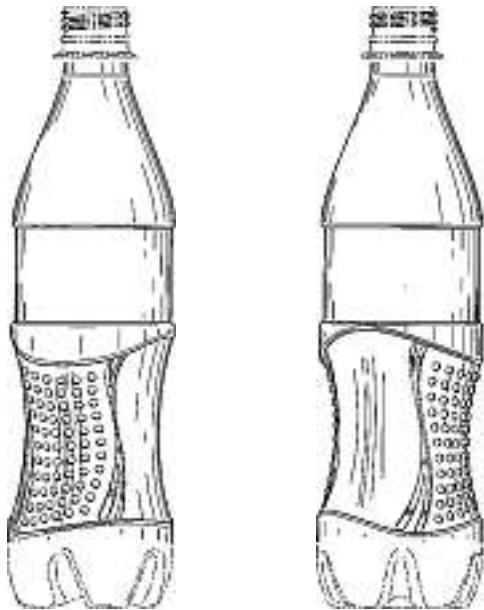
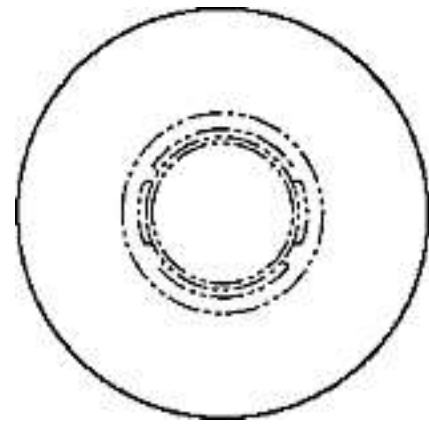
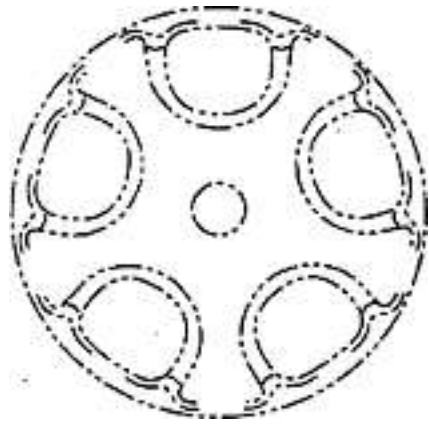

1

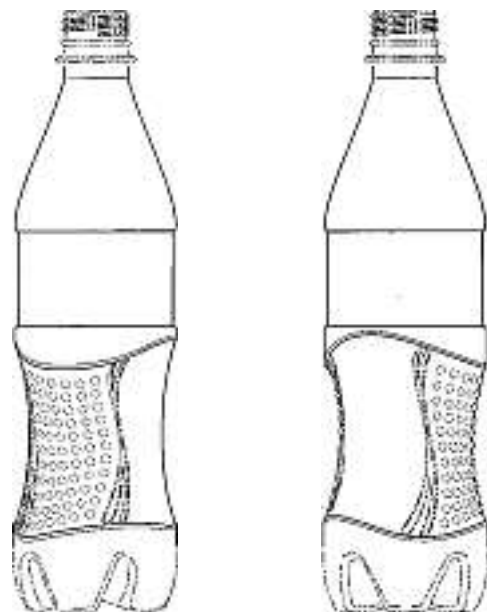
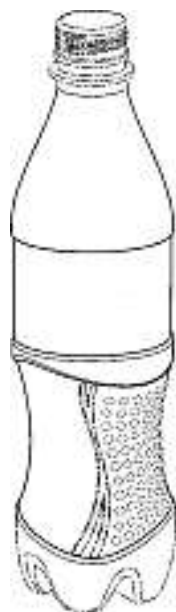

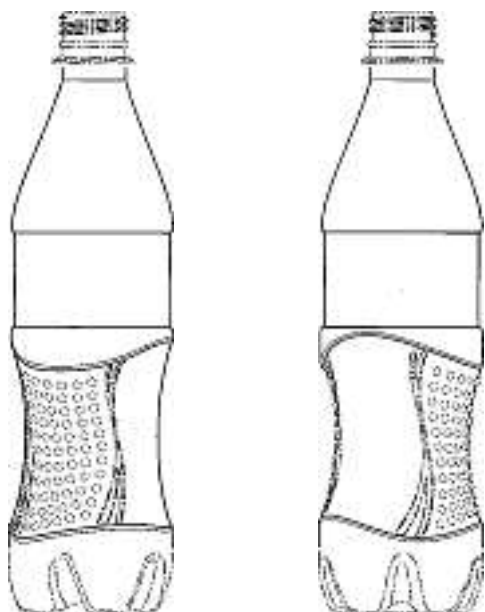

2



PD1

Cl. 09-03 133 638 24.01.2007

1 Design – Getränkedose  
 Hinterleger: Martin Blum, Bahnhofplatz,  
 3762 Erlenbach im Simmental;  
 Peter Blum, Bahnhofplatz, 3762 Erlenbach im Simmental  
 Vertreter: Martin Blum, 3762 Erlenbach im Simmental  
 Beschreibung des Designs: Nachbildung der optischen  
 Merkmale einer Alu-Getränkedose in PET



Cl. 09-03 133 639 24.01.2007

1 design – boîte  
 Déposant: Société des Produits Nestlé SA, 1800 Vevey  
 Designer: Jacques Dafflon, Broc  
 Mandataire: Nestec S.A., 1800 Vevey

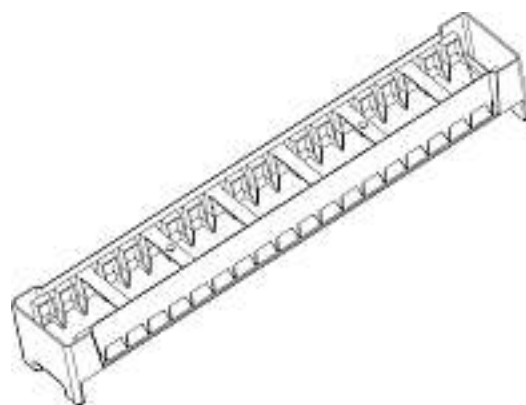
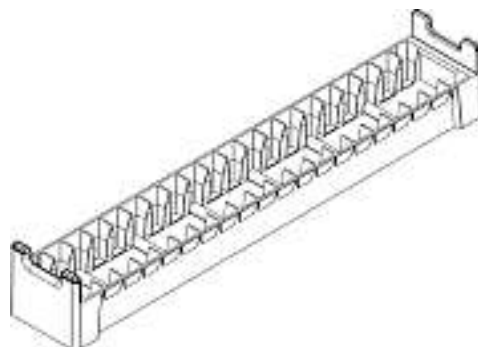

FL 64102

Cl. 10-02 133 642 22.01.2007

1 design – montre  
 Déposant: Robert Wan Luxury Ltd, Room 2410 24/F China  
 Resources Building, 26, Harbour Road, Wanchai, HK  
 Designer: Daryoush Shafa, Rueil Malmaison  
 Mandataire: Bovard AG, 3000 Bern 25  
 Priorité: EM, 31.07.2006

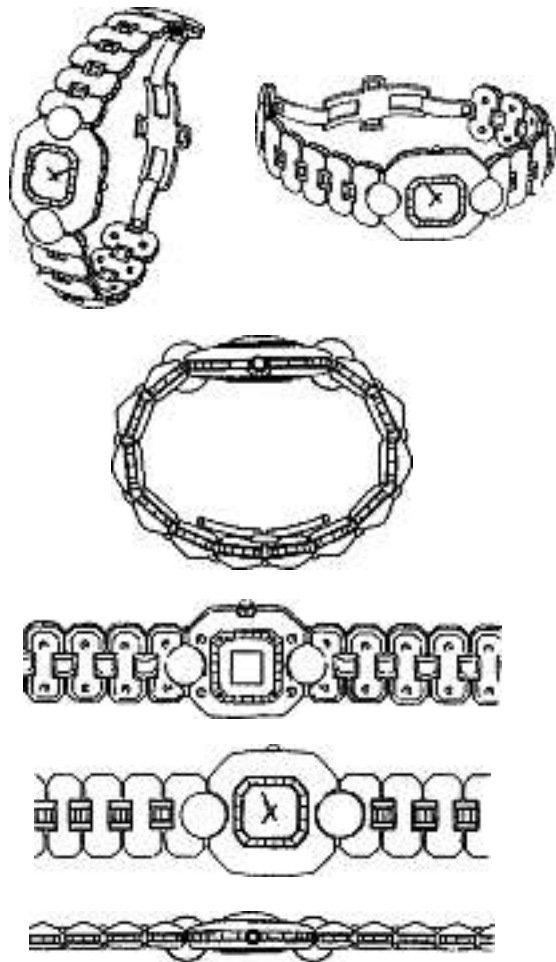

1

Cl. 10-07                      **133 645**                      24.01.2007  
 2 design – boîtiers pour montre  
 Déposant: Intertime (Far East) Holdings Ltd., 605-6 Wah Chun  
 Industrial Centre, 95 Chai Wan Kok Street,  
 Tsuen Wan (N.T.), HK  
 Designer: Rajesh Vashi Khemlani, Tsuen Wan  
 Mandataire: Katzarov S.A., 1227 Genève



15746/CH-1





15746/CH-2

Cl. 10-07 133 646 26.01.2007  
 3 design – cadrans de montres  
 Déposant: Alphonse Di-Tsimba Mbambi-Ngoma,  
 rue François-Durafour 12, 1220 Les Avanchets



MKA1



MKA2



MKA3

Cl. 10-07 133 647 31.01.2007  
 9 design – boîtes de montres  
 Déposant: G. Maljian et Fils, P.O. Box 90183 – Jdeidet-Elmetn,  
 Beyrouth, LB  
 Designer: Karoghlanian Vasken, Beyrouth  
 Mandataire: Moetteli & Associés SàRL, 9000 St. Gallen



1



2



3



4



7



5



8



6



9

Cl. 11-02 133 650 19.01.2007  
3 design – trophées  
Déposant: Union des Associations Européennes de Football (UEFA), Route de Genève 46, 1260 Nyon 2  
Designer: Ed Reynolds, Londres; Darrell Pockett, Londres  
Mandataire: Wild Schnyder AG, 8032 Zürich







T-1



T-2



T-3



Resonanzoptimierer GP1



Resonanzoptimierer GP2

Cl. 17-03                      **133 652**                      13.02.2007  
 2 Design – Musikinstrumententeil  
 Hinterleger: Josef Toldo, Postplatz, 9478 Azmoos

Cl. 19-08                      **133 653**                      19.01.2007  
 3 Design – Formulare  
 Hinterleger: gammaRenax AG, Dorfstrasse 4, 8037 Zürich  
 Designer: Severin Gallo, Zürich  
 Vertreter: Kikinis Rohner Schwenninger Weinmann,  
 8032 Zürich

Technische Zeichnung		Beschreibung	
Titel	Blatt	Material	Maßstab
Seite 1			
Technische Zeichnung Blatt 1 von 1 Maßstab: 1:1 Datum: 17.01.2007		Beschreibung: 4 Design - Mobiliar de Präsentation Designer: Olivier Leu, Denens	

4473-D01

Technische Zeichnung		Beschreibung	
Titel	Blatt	Material	Maßstab
Seite 1			
Technische Zeichnung Blatt 1 von 1 Maßstab: 1:1 Datum: 17.01.2007		Beschreibung: 4 Design - Mobiliar de Präsentation Designer: Olivier Leu, Denens	

4473-D02

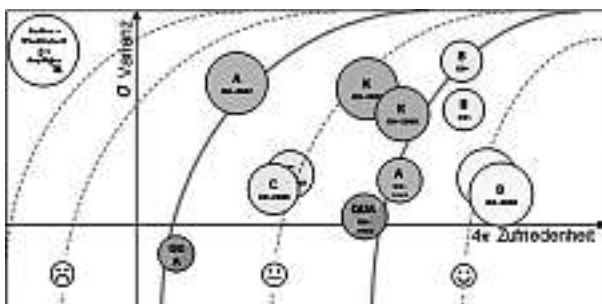

4472-D03

Cl. 19-08                      **133 654**                      29.01.2007  
 1 Design – Druckvorlage  
 Hinterleger: Keybobby Services, T. Planzer, Hertistrasse 57,  
 6300 Zug  
 Designer: Thomas Planzer, Zug



Keybobby01

Cl. 20-02                      **133 655**                      17.01.2007  
 4 design – mobilier de présentation  
 Dépositant: Synopsis Communication Limited,  
 Route de Cossonay 100, 1008 Prilly  
 Designer: Olivier Leu, Denens



1

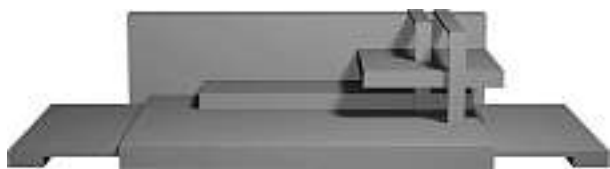

2



3



4

Cl. 21-01 133 656 30.01.2007

1 Design – Wasserspielzeug  
 Hinterleger: CPD Handelsgesellschaft m.b.H., Am Teich 11,  
 Mannersdorf a. Lthg., AT  
 Designer: Helmut Totz, Mannersdorf a. Lthg.  
 Vertreter: Hans Rudolf Gachnang, Patentanwalt,  
 8501 Frauenfeld

Beschreibung des Designs: Das Wasserspielzeug weist im wesentlichen Kegelstumpfform auf und wird als so genannte «Wasserkanone» verwendet, indem es mit der grösseren Öffnung voraus durch das Wasser gezogen wird, wodurch aus der rückwärtigen Öffnung ein Wasserstrahl spritzt.





1

Cl. 24-02 133 658 16.01.2007  
 1 Design – Titer-Platte  
 Hinterleger: F. Hoffmann-La Roche AG,  
 Grenzacherstrasse 124, 4070 Basel  
 Designer: Christof Fattinger, Blauen; Patrick Iaiza, Saint Louis;  
 Thomas Zumstein, Weil am Rhein  
 Vertreter: A. Braun, Braun, Héritier, Eschmann AG,  
 Patentanwälte, 4051 Basel

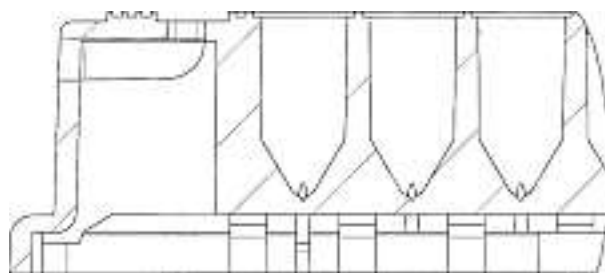
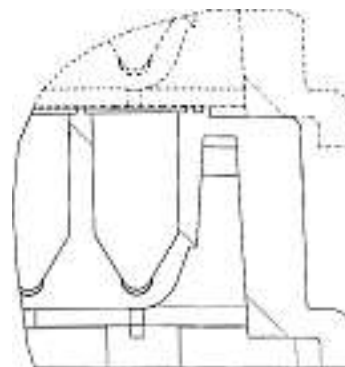
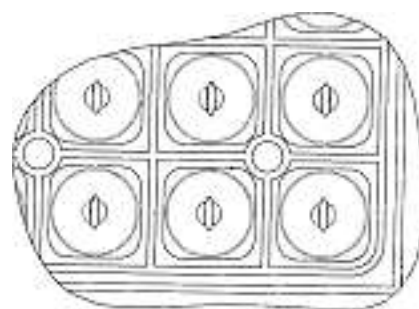
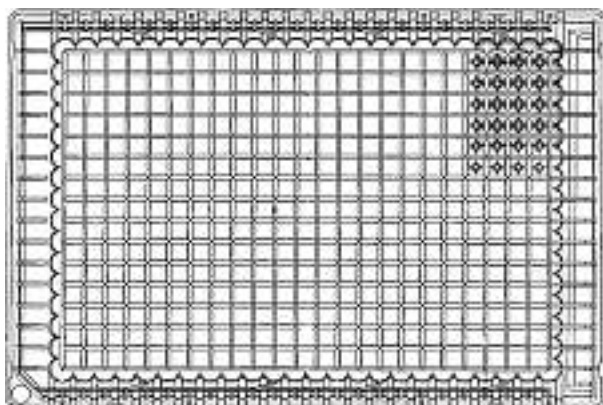
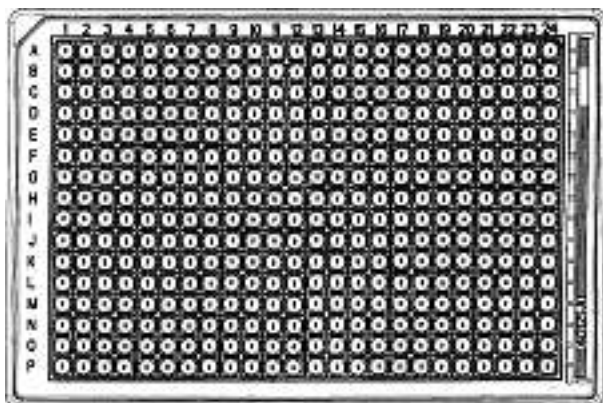

D35358CH00

Cl. 24-04 133 659 22.12.2006  
 6 Design – Dosiergeräte für Arzneimittel  
 Hinterleger: RAUMEDIC AG, Münchberg, DE  
 Designer: Thomas Jakob, Selb  
 Vertreter: Isler & Isler, 6342 Baar  
 Priorität: EM, 04.07.2006; EM, 04.07.2006; EM, 04.07.2006;  
 EM, 04.07.2006; EM, 04.07.2006; EM, 04.07.2006

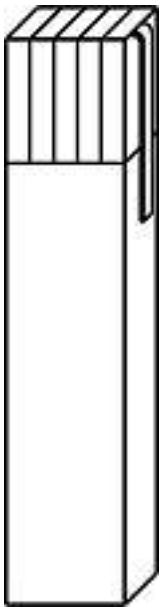

RSH111-1

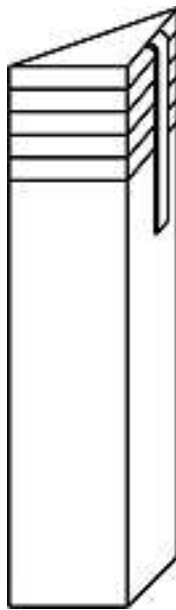

RSH111-2

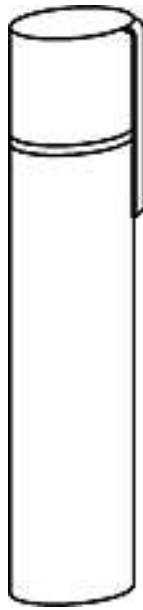

RSH111-3



RSH111-4





RSH111-5



RSH111-6

Cl. 24-04 133 660 23.01.2007  
14 Design – Schnuller  
Hinterleger: MAM Babyartikel Gesellschaft M.B.H.,  
Lorenz-Mandl-Gasse 50, Wien, AT  
Designer: Peter Röhrig, Wien  
Vertreter: E. Blum & Co. AG, Patent- und Markenanwälte  
VSP, 8044 Zürich

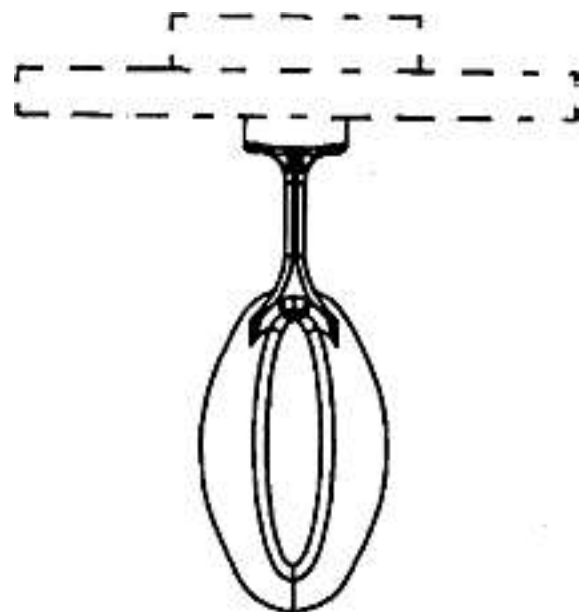
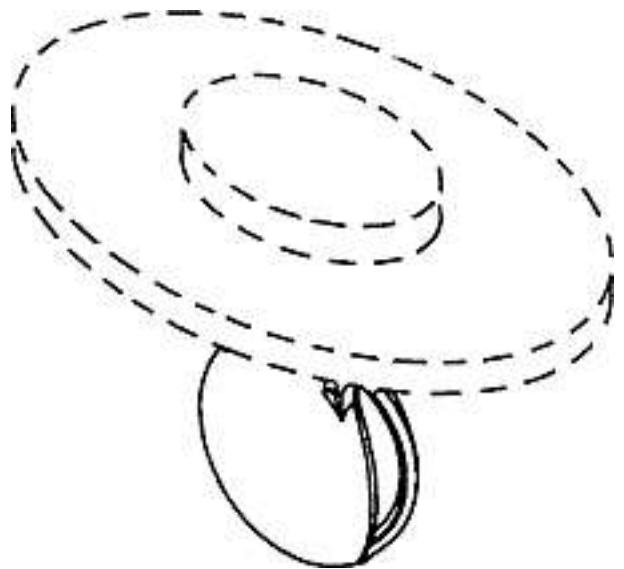
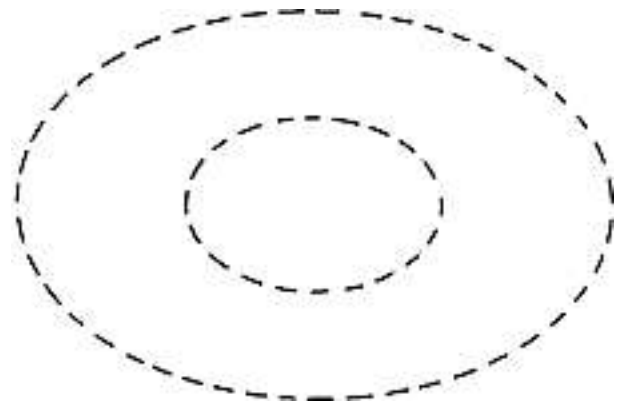

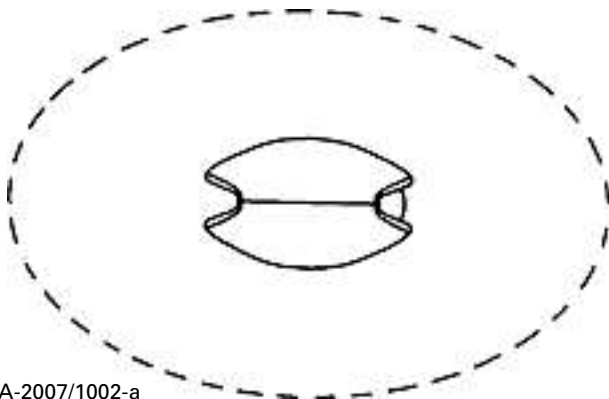
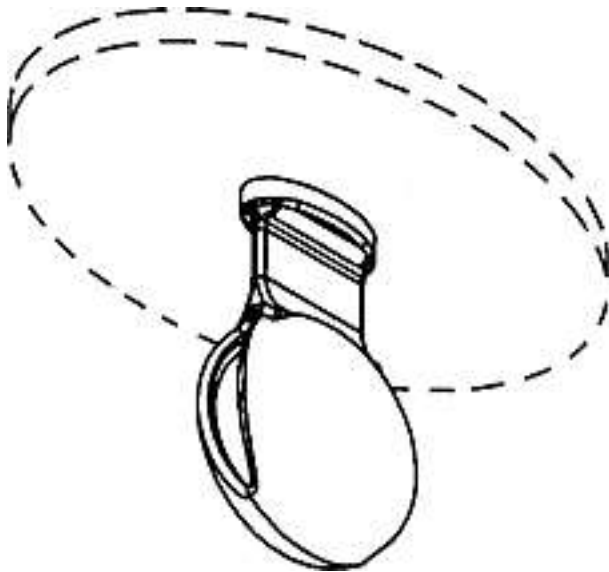
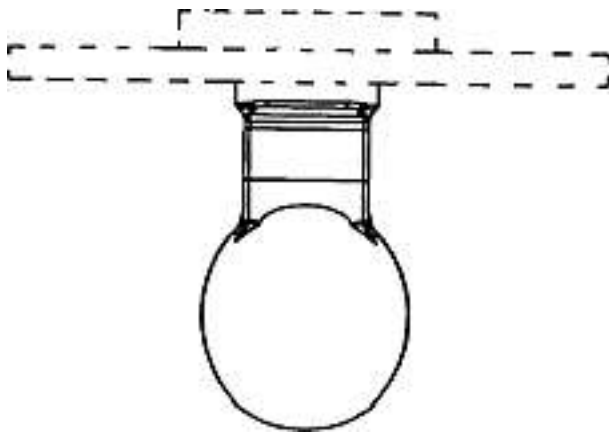

A-2007/1002-a

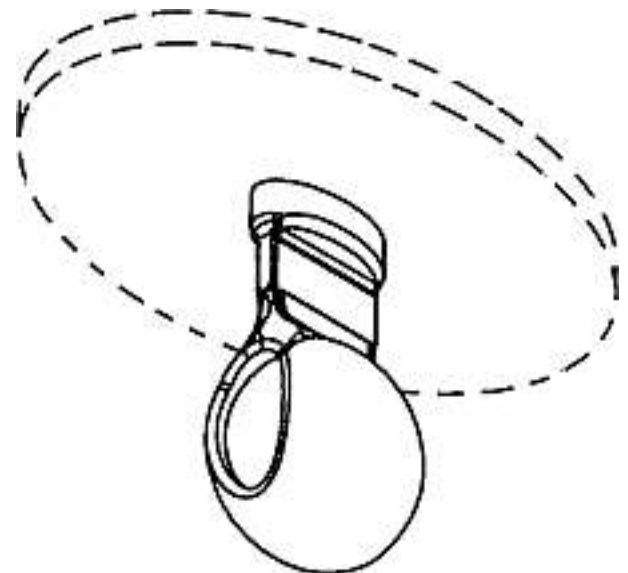
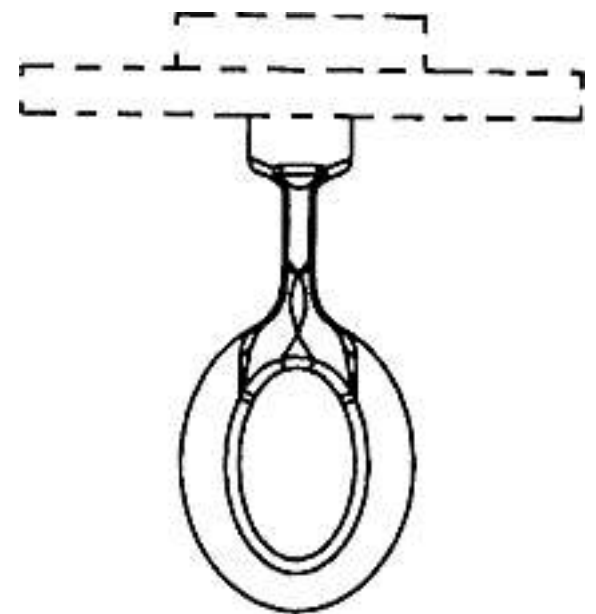
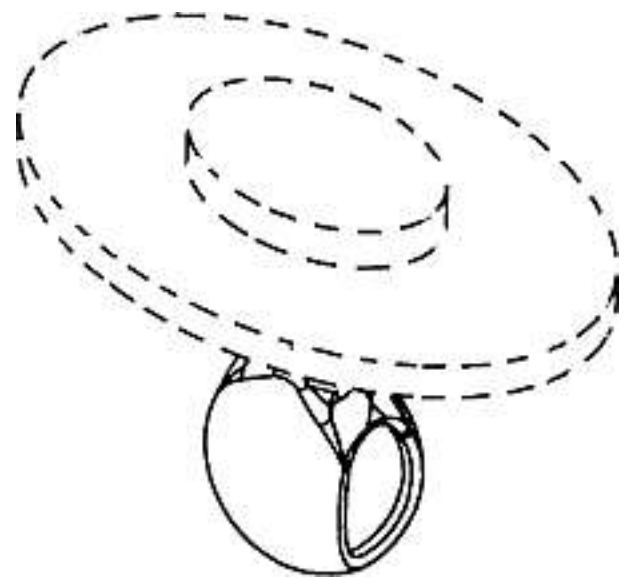
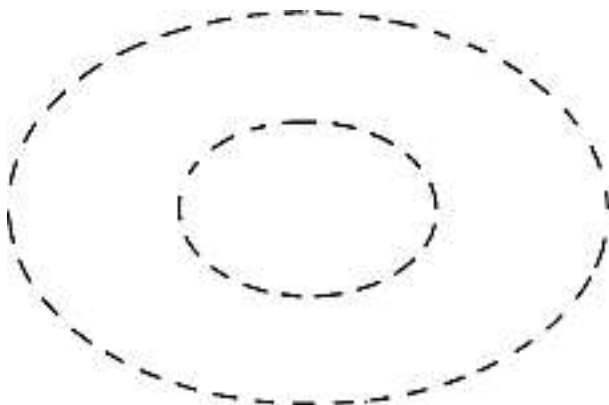

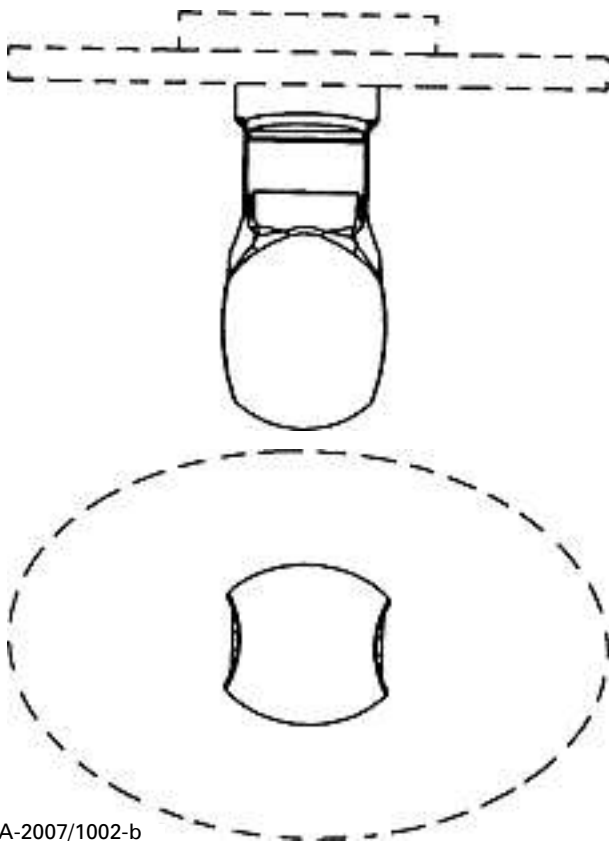

A-2007/1002-b

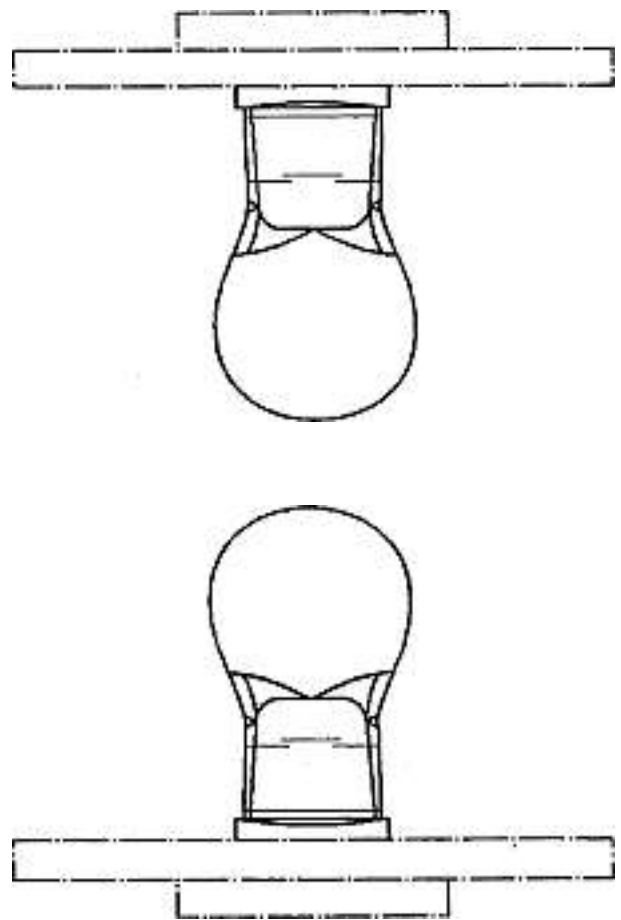
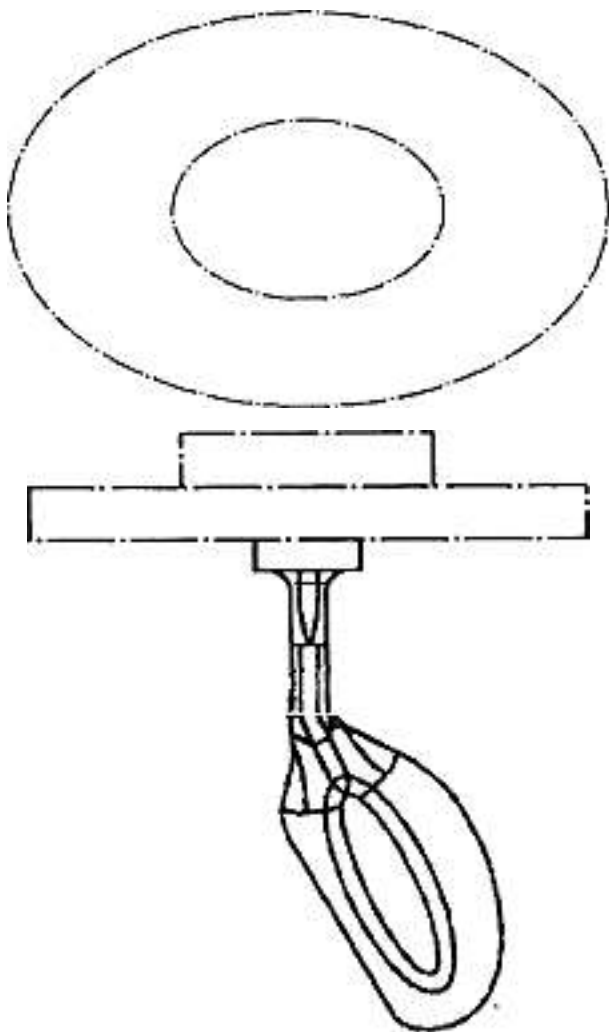

A-2007/1002-c



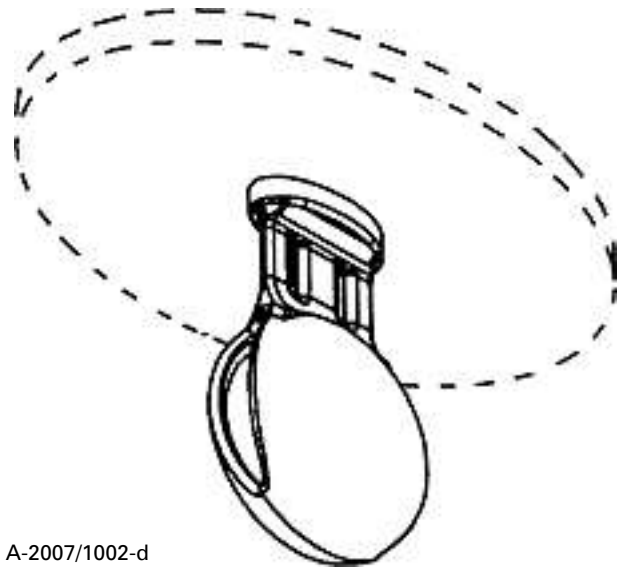
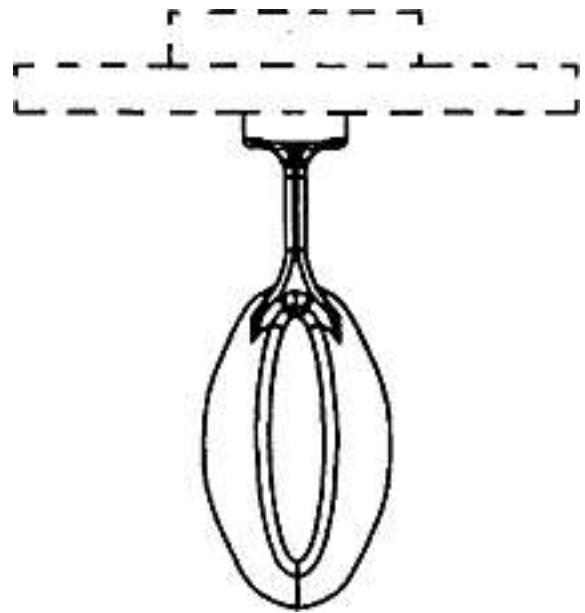
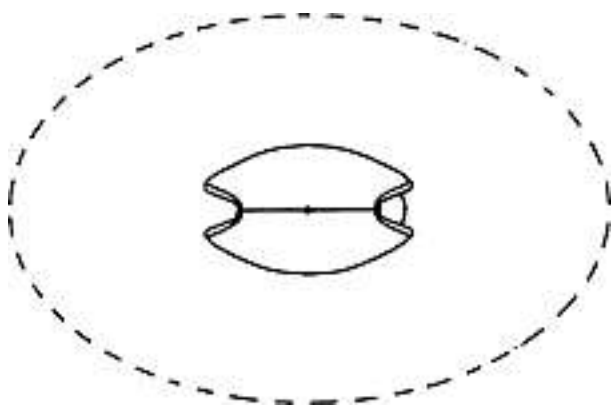
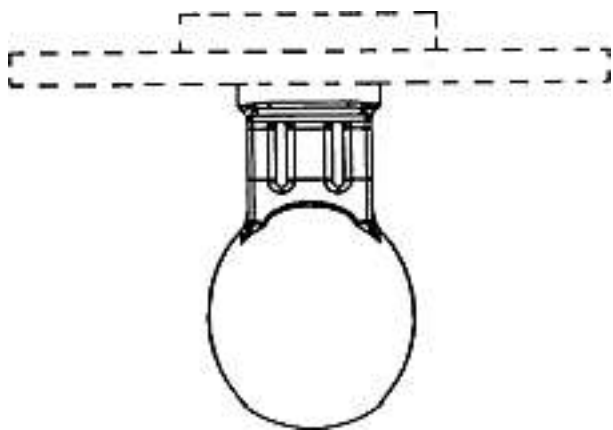
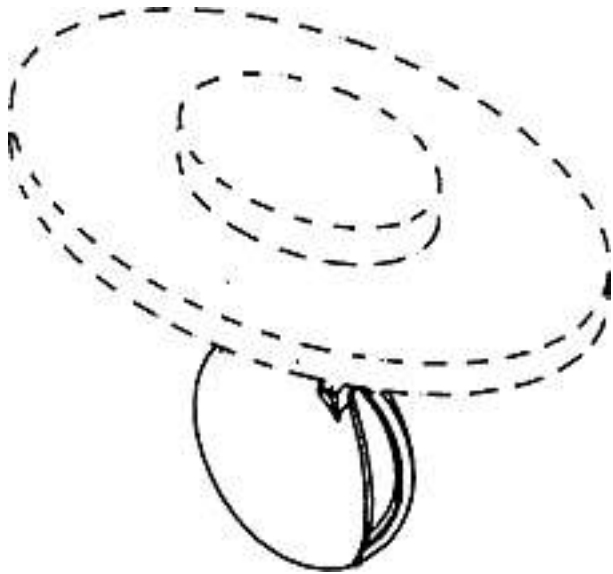
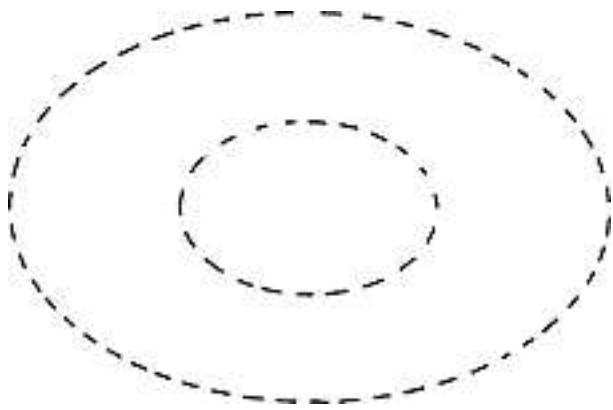

A-2007/1002-d

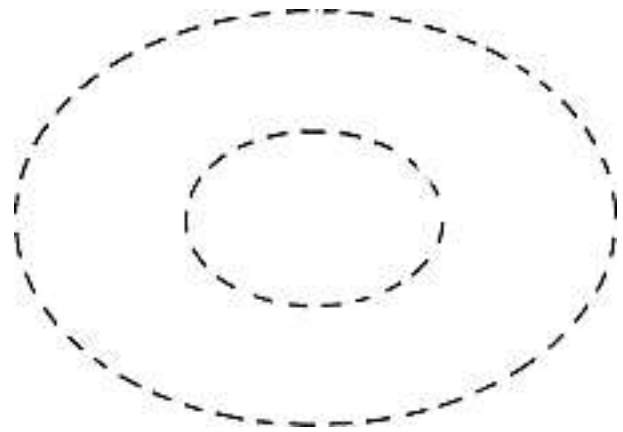

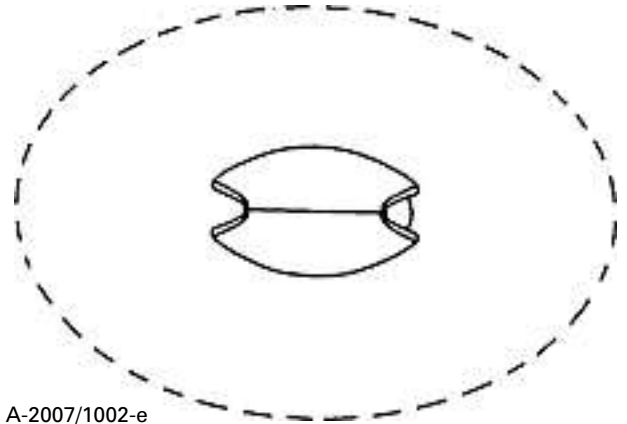
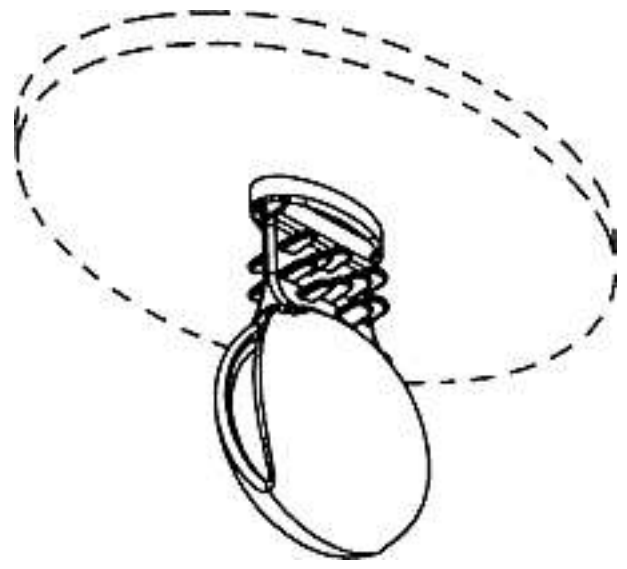
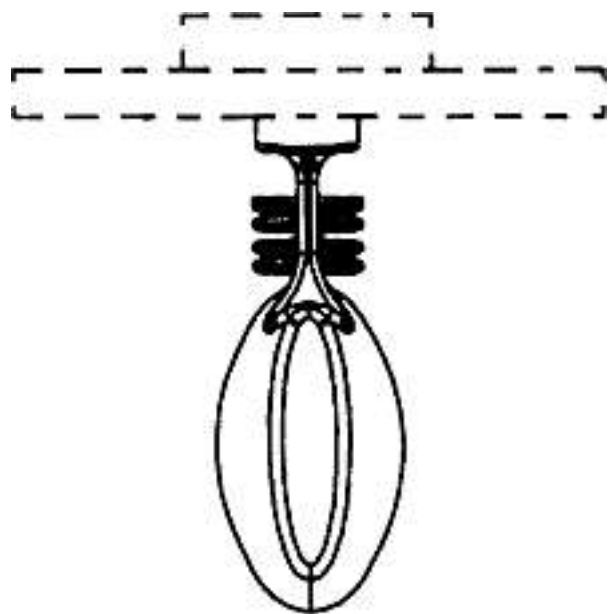
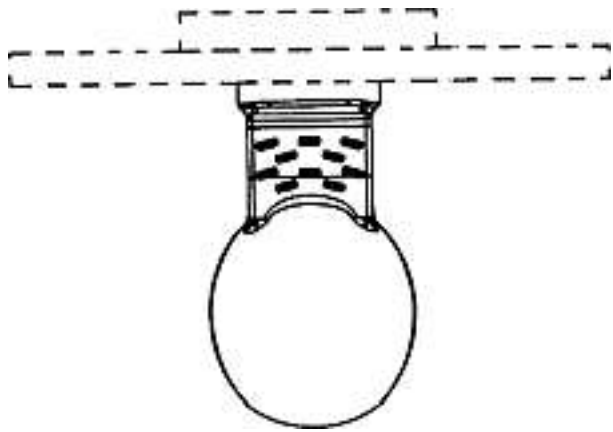
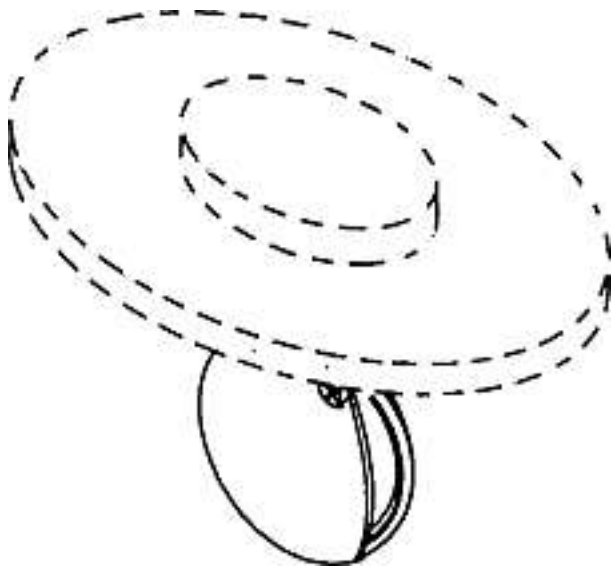

A-2007/1002-e

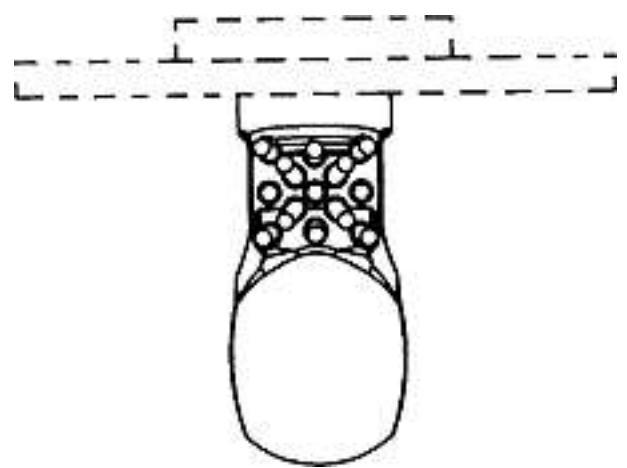
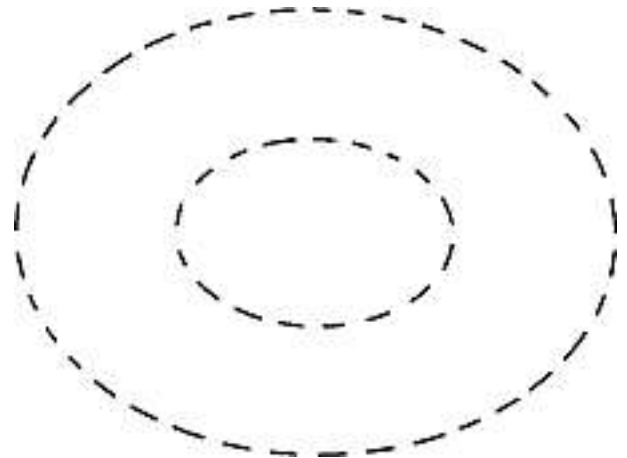

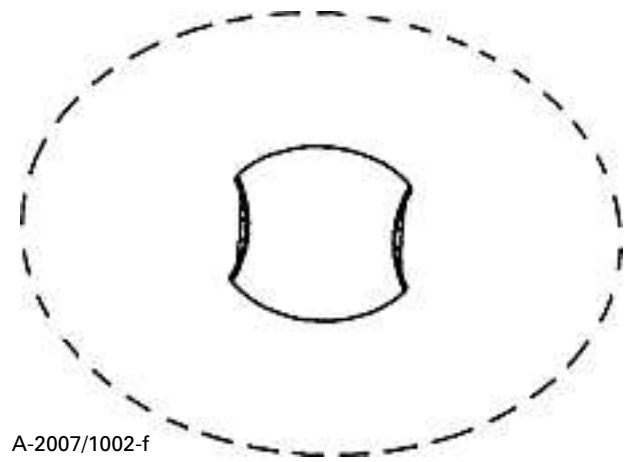
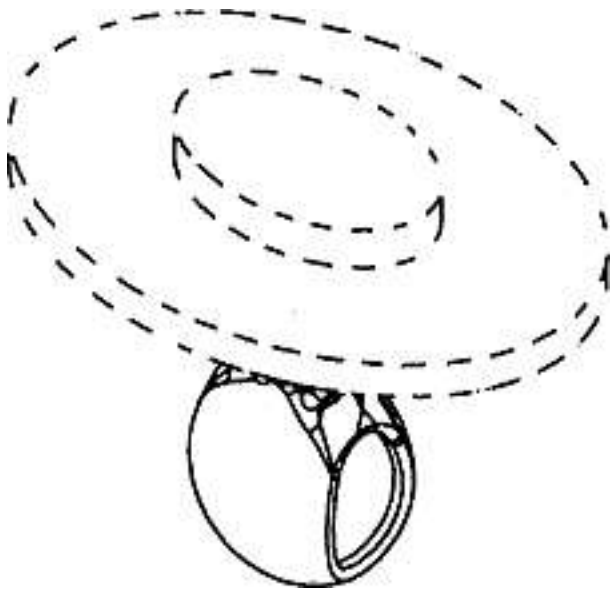

A-2007/1002-f

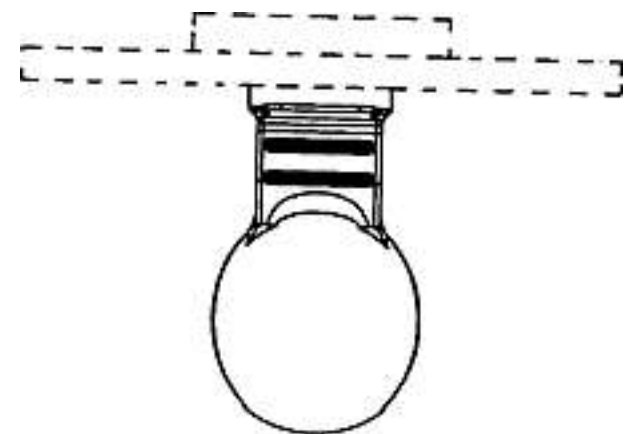
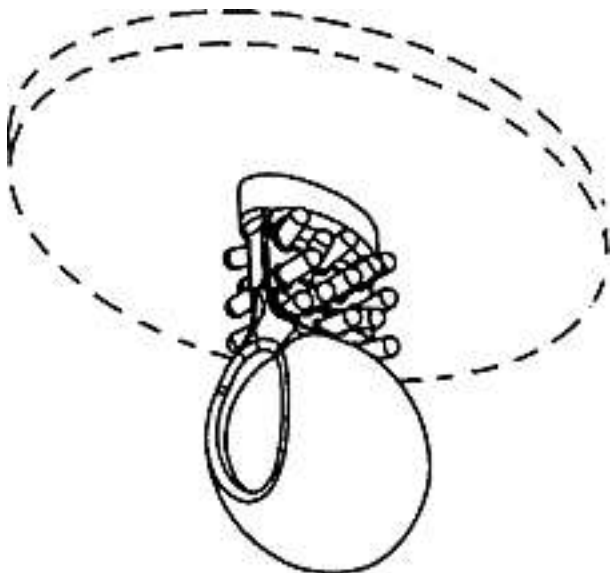
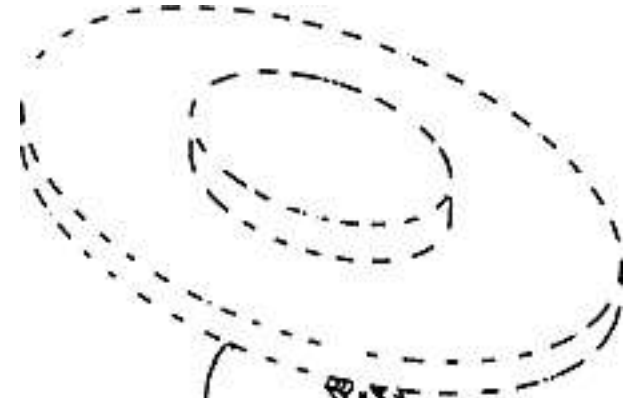
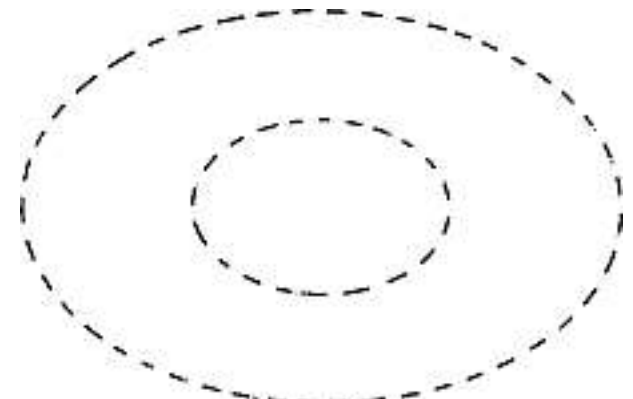
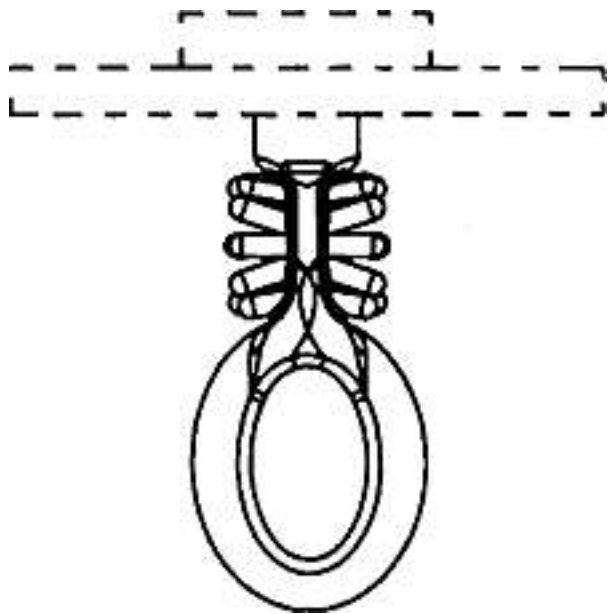

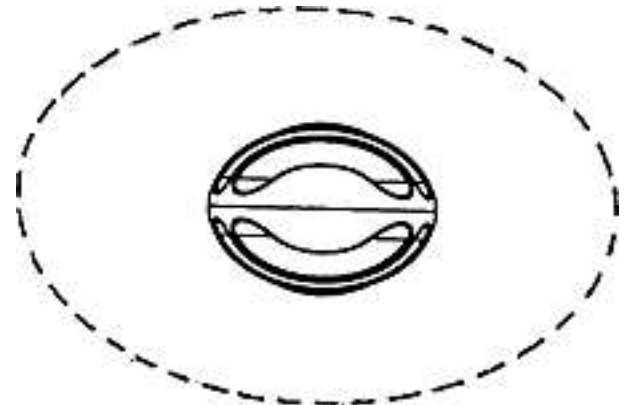
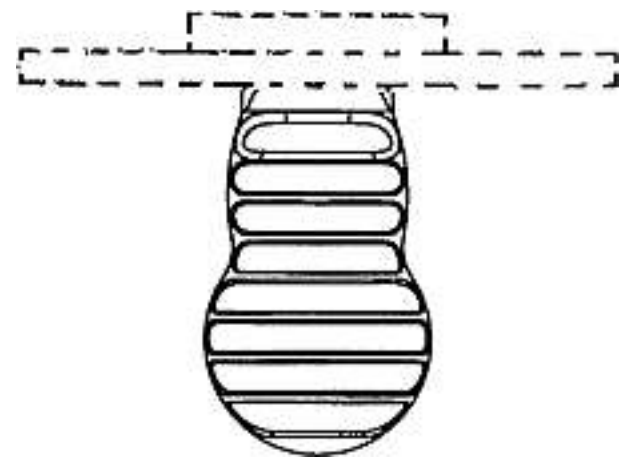
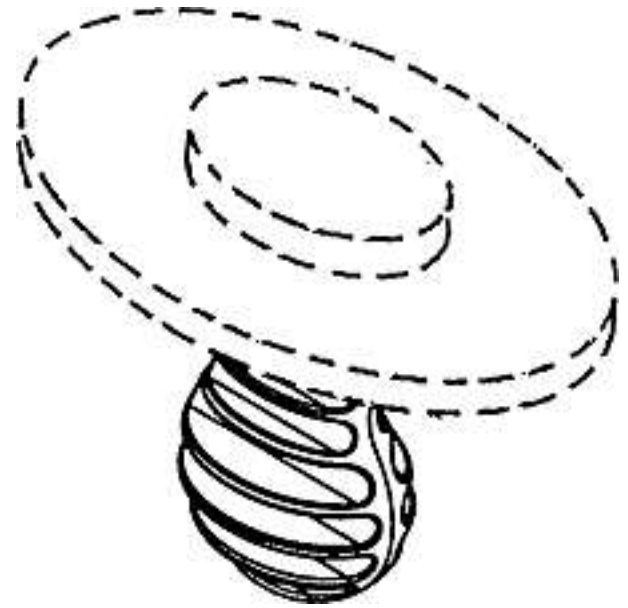
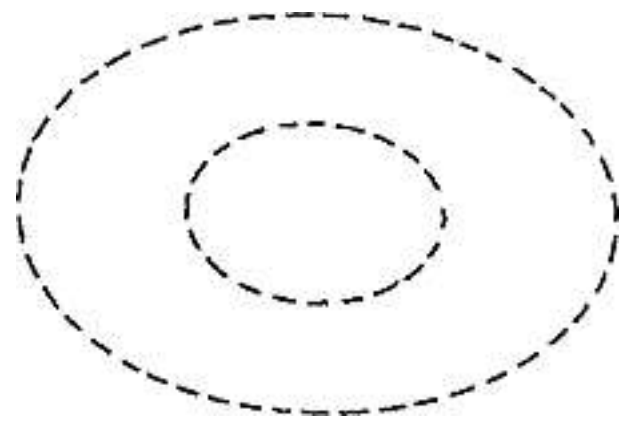
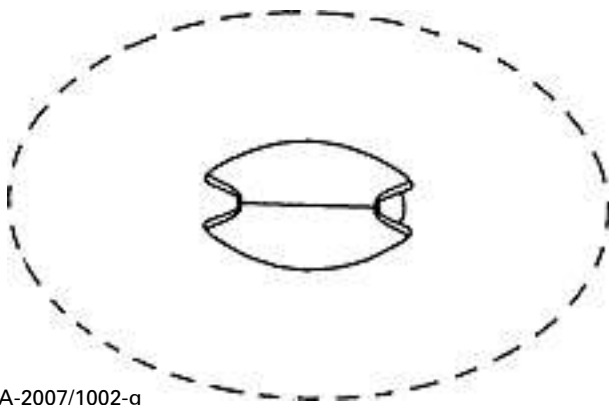
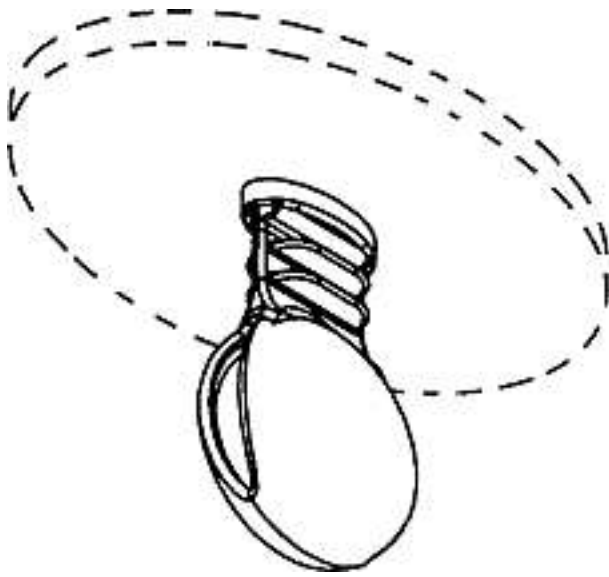
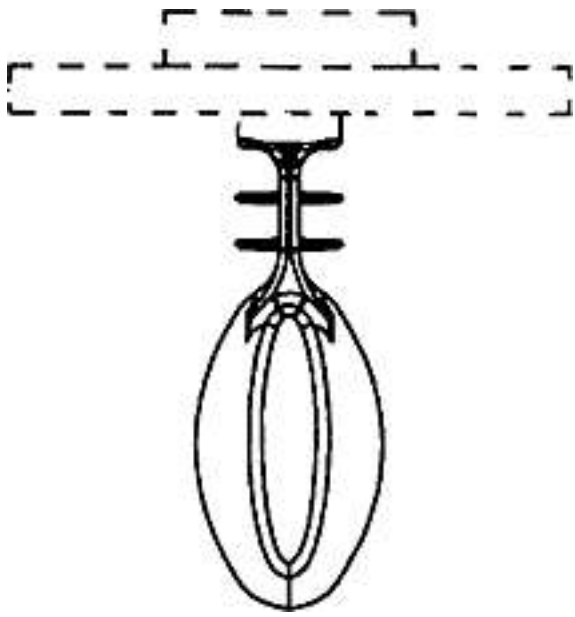

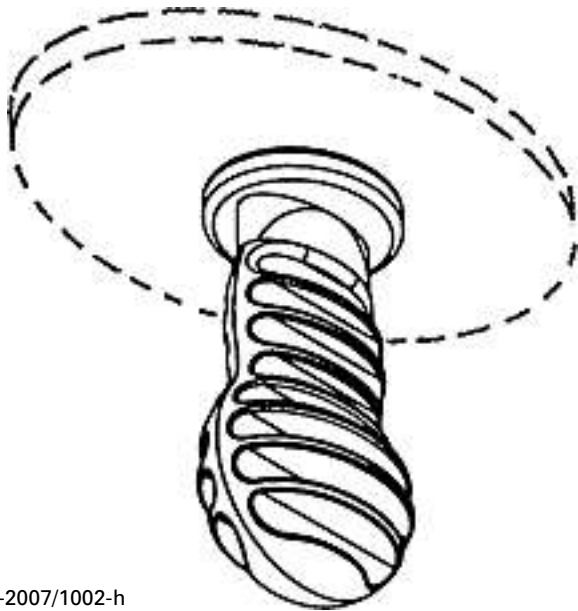
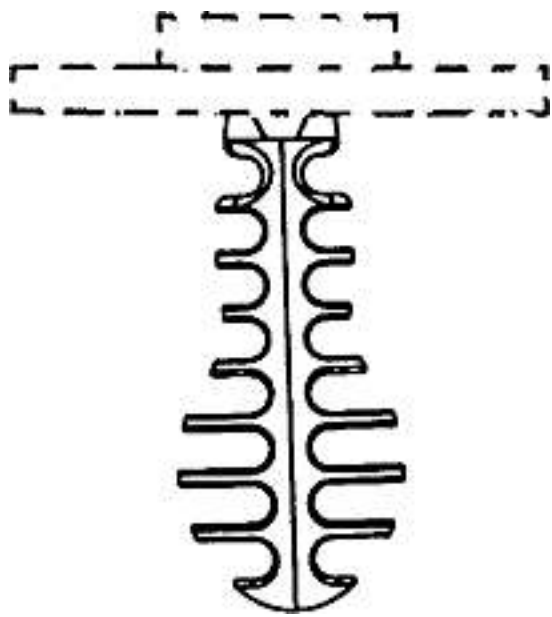

A-2007/1002-h

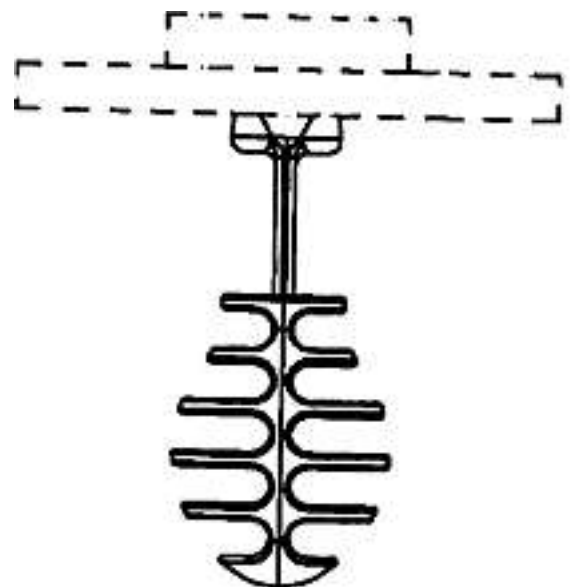
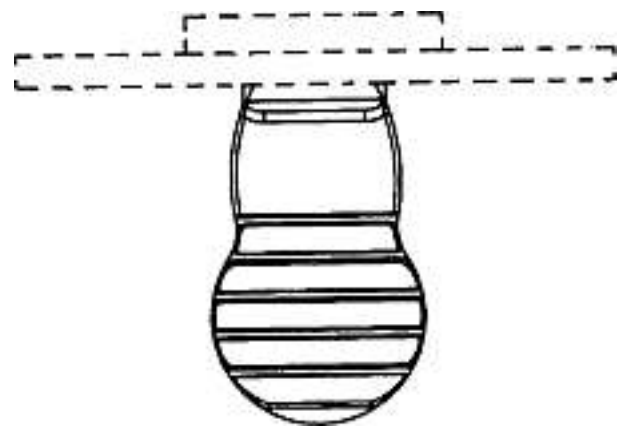
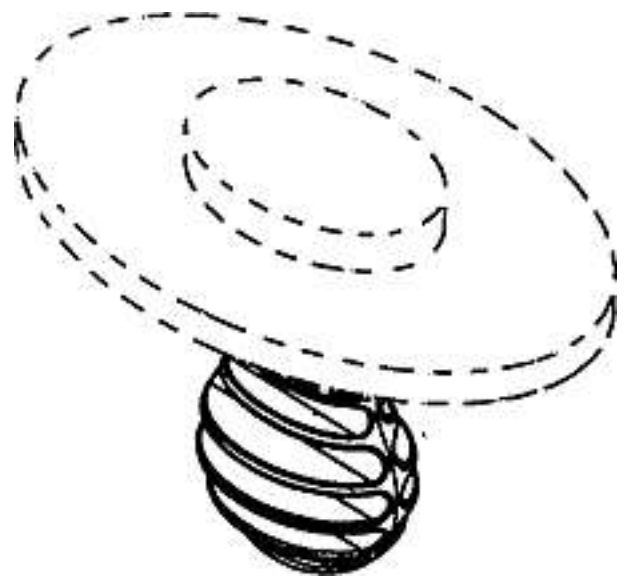
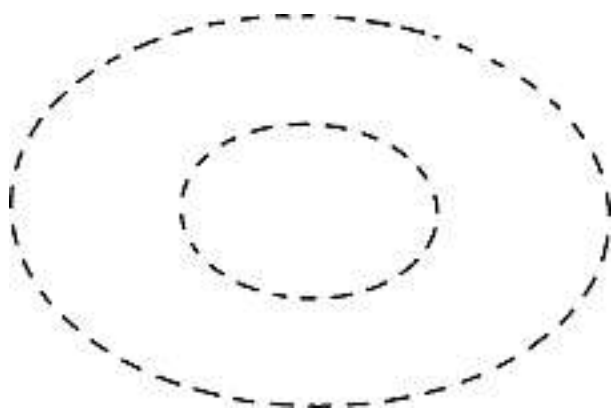

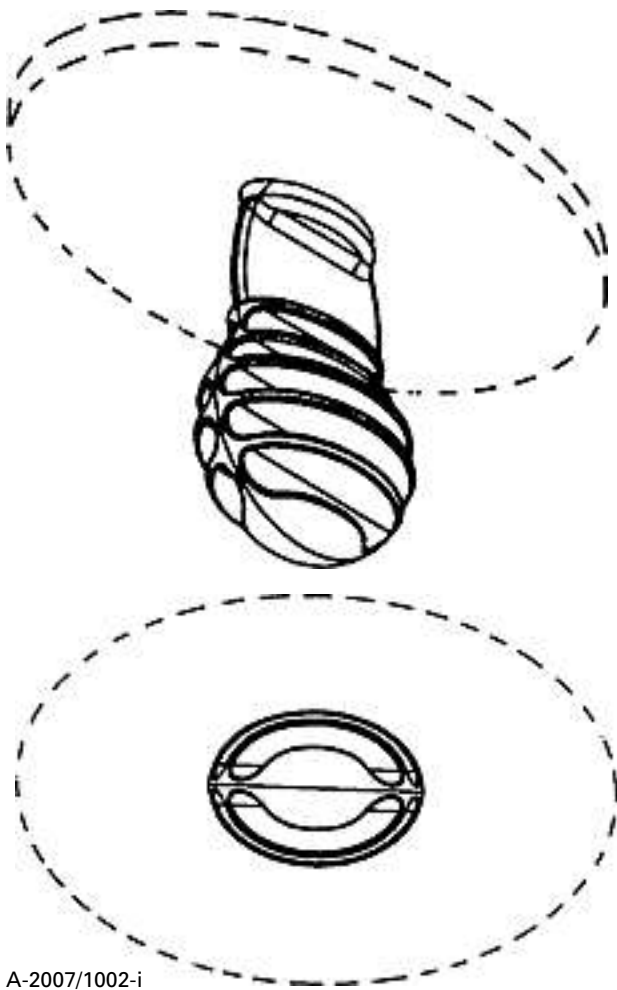

A-2007/1002-i

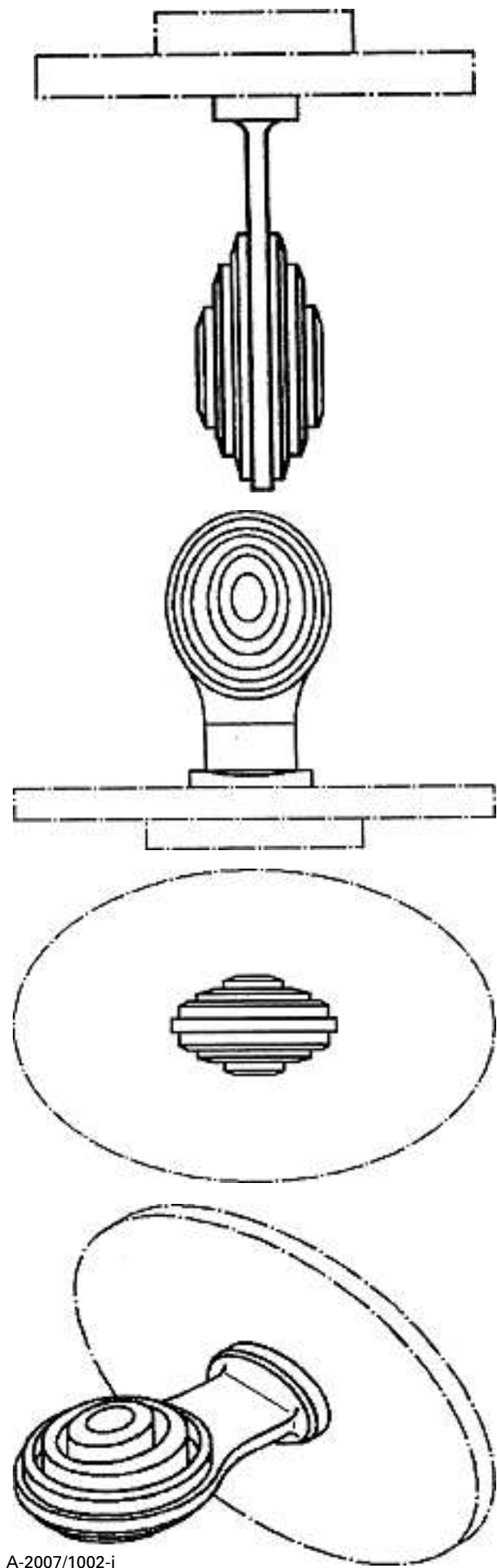
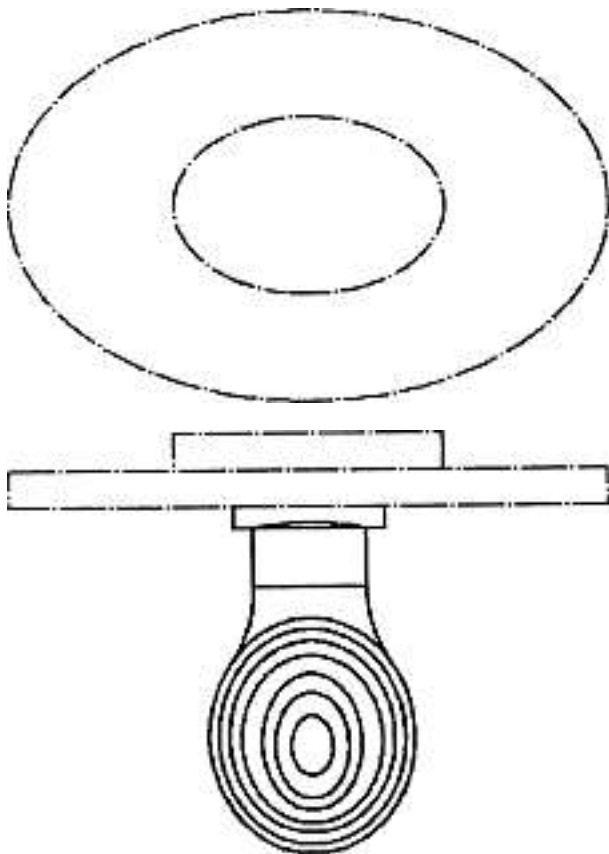

A-2007/1002-j

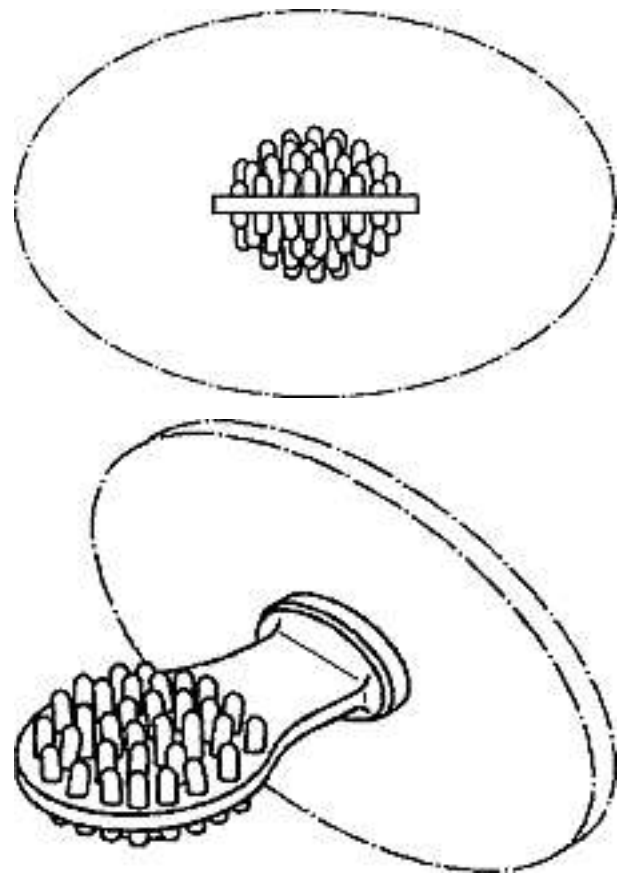
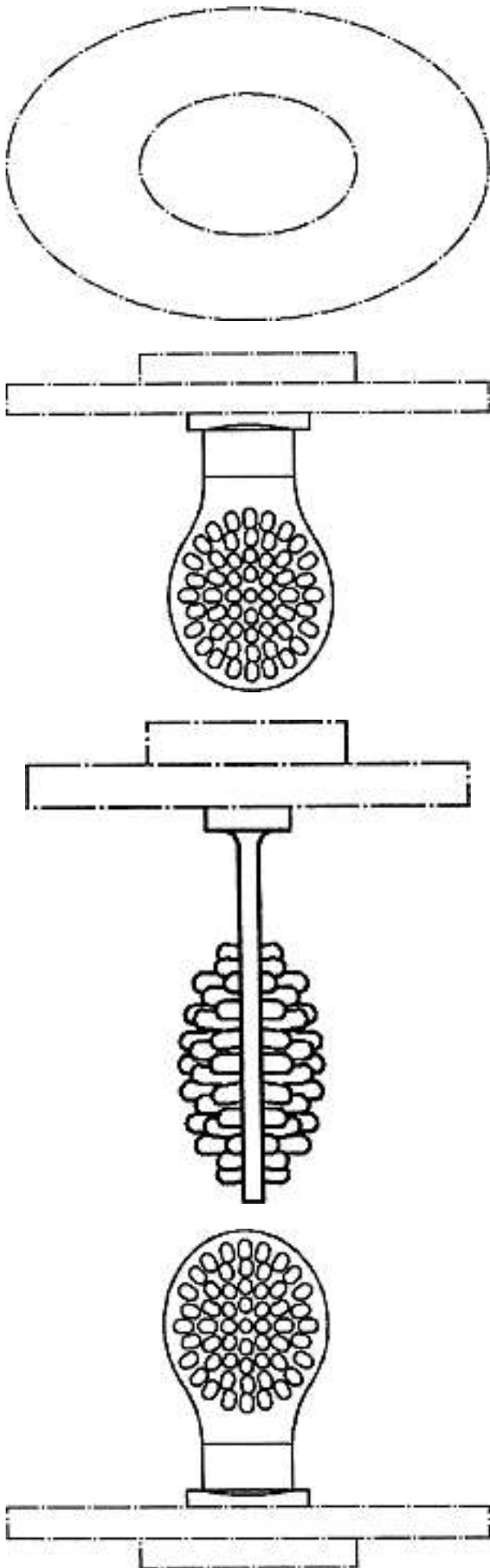

A-2007/1002-k

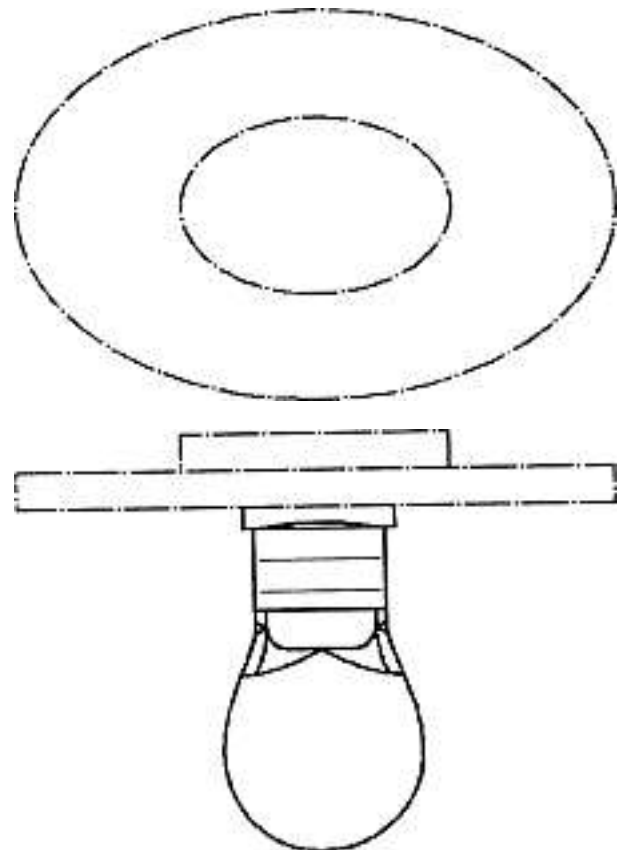

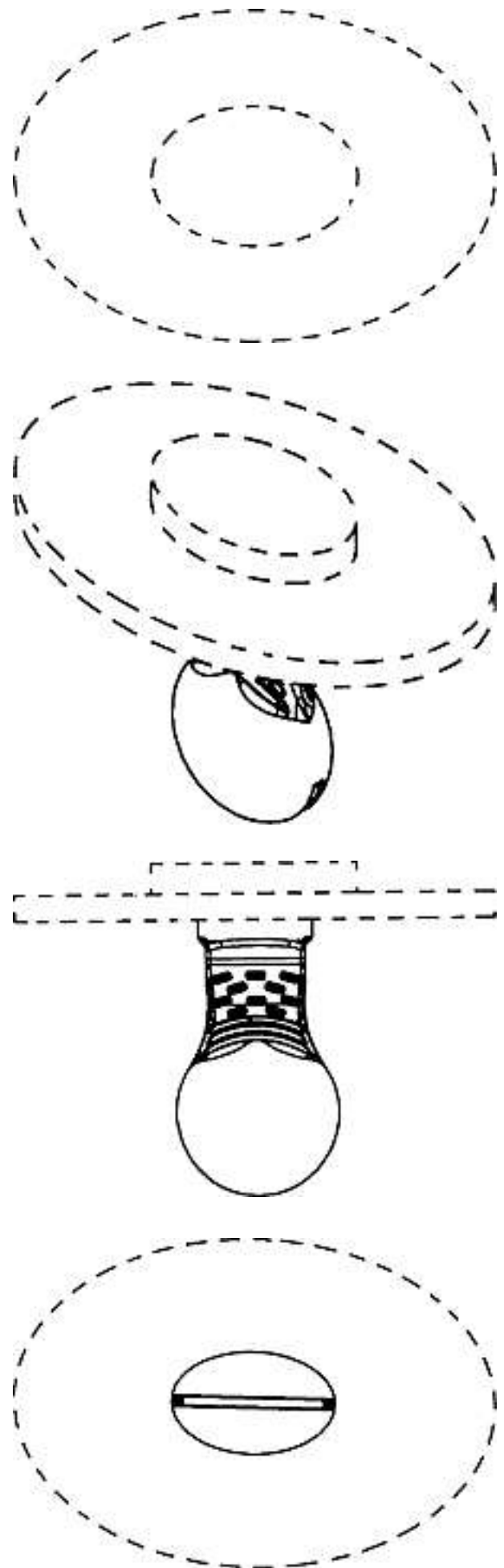
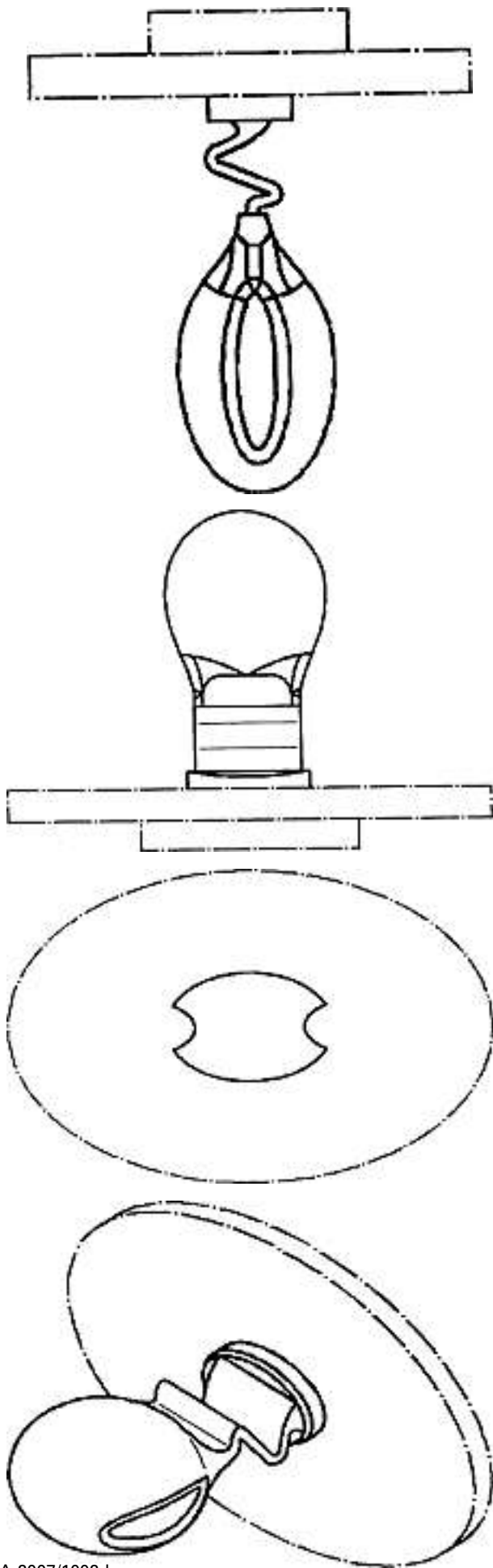

A-2007/1002-I



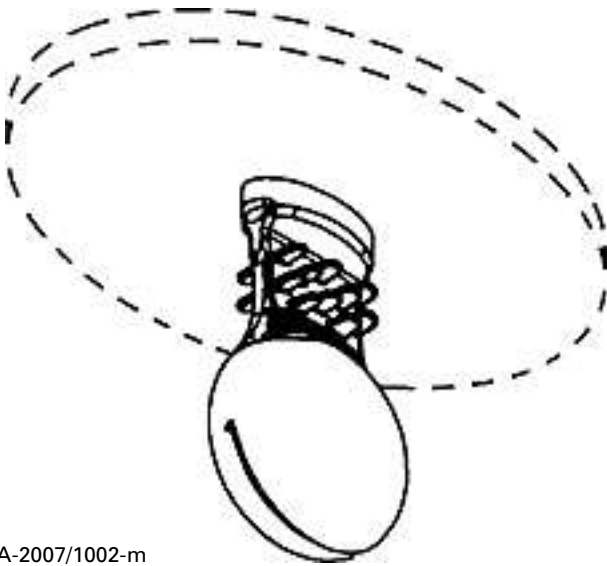
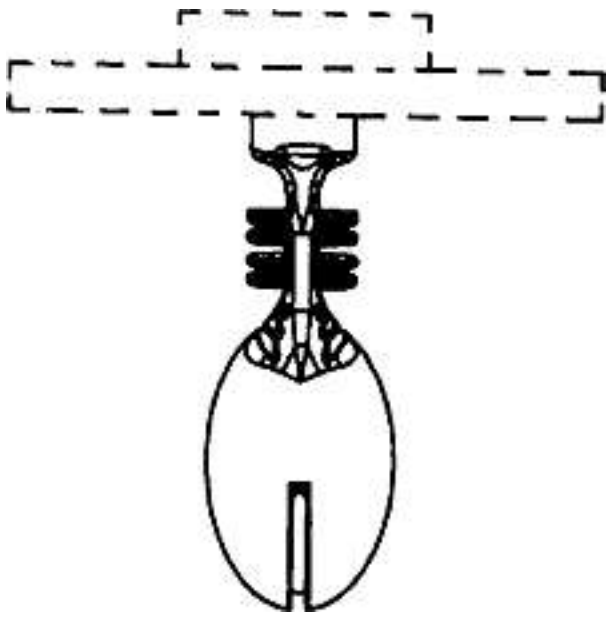

A-2007/1002-m

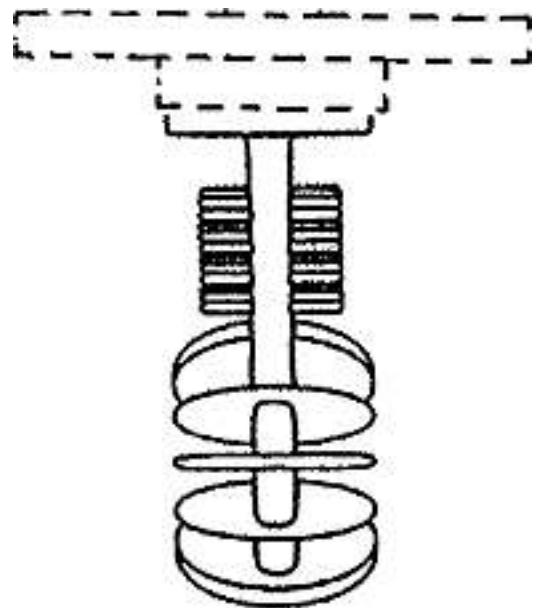
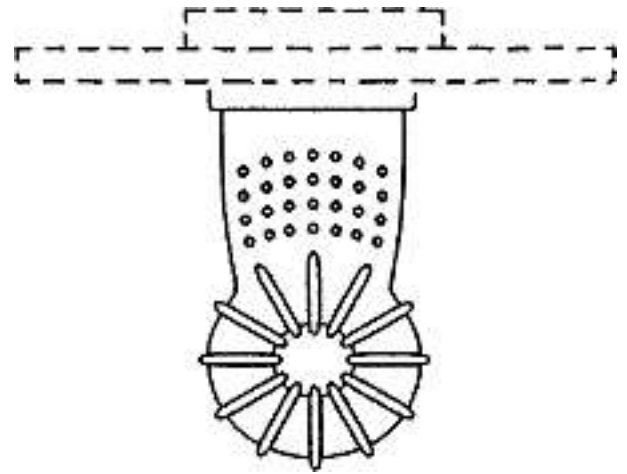
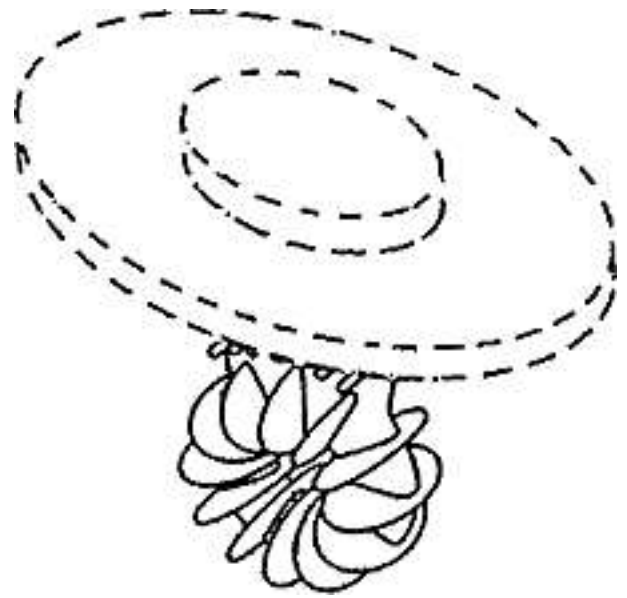
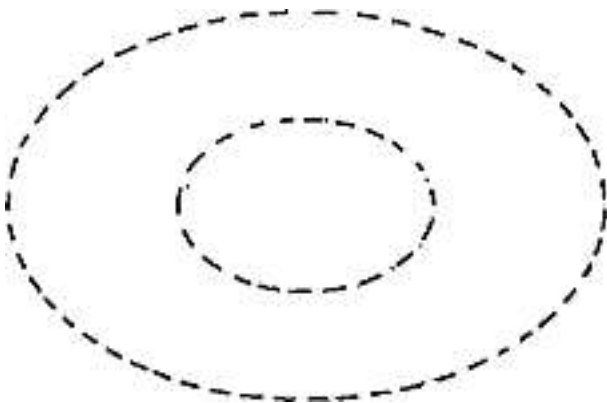

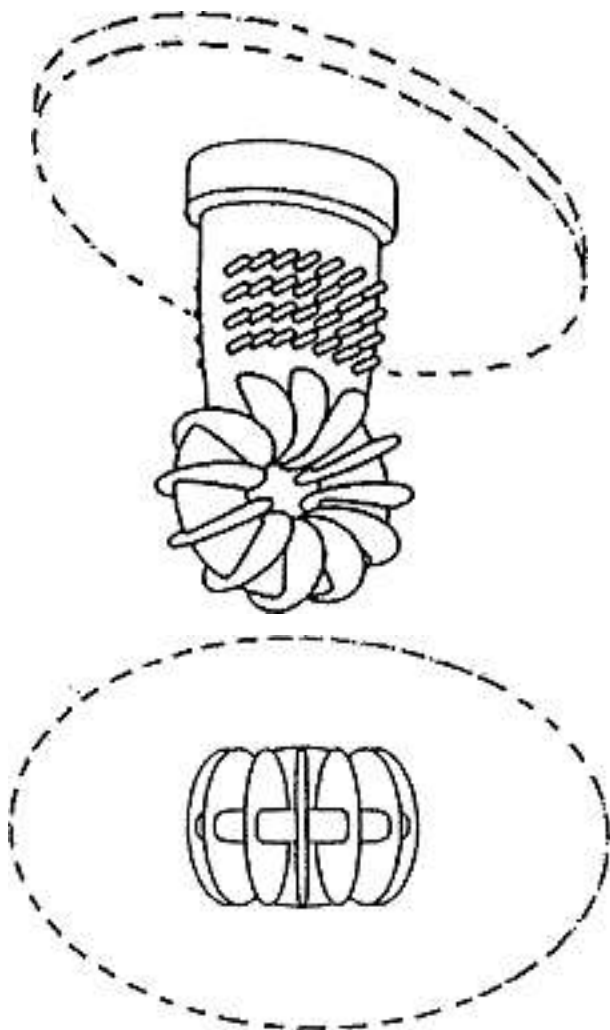

A-2007/1002-n

Cl. 24-99 133 661 22.01.2007  
 2 Design – Hörgerät  
 Hinterleger: Phonak AG, Laubisrütistrasse 28, 8712 Stäfa  
 Designer: Richard Niccolai, Uster; Jan Angst, Horgen;  
 Urs Zueger, Stäfa; Andi Vonlanthen, Remetschwil  
 Vertreter: Troesch Scheidegger Werner AG, Patent- und  
 Markenanwälte, 8126 Zumikon

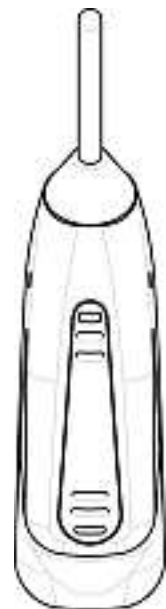
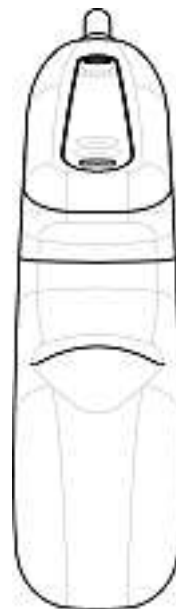

D300098-1



D300098-2



Cl. 25-03 133 662 12.01.2007  
1 Design – Raumform  
Hinterleger: Marianne Hopsch, Rennweg 35, 8001 Zürich

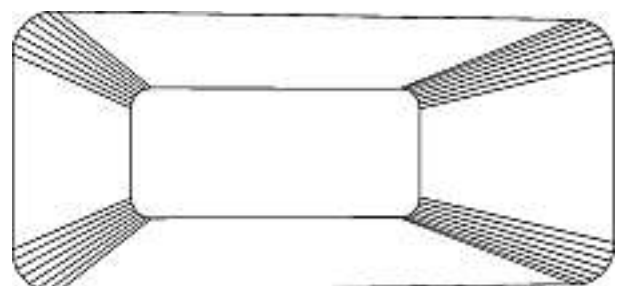
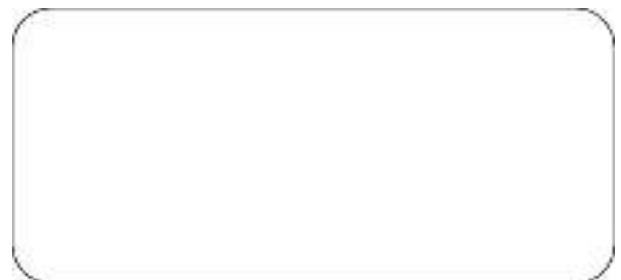
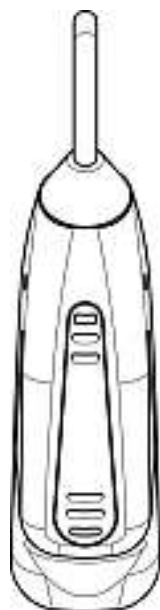
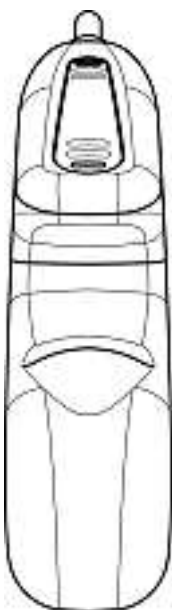
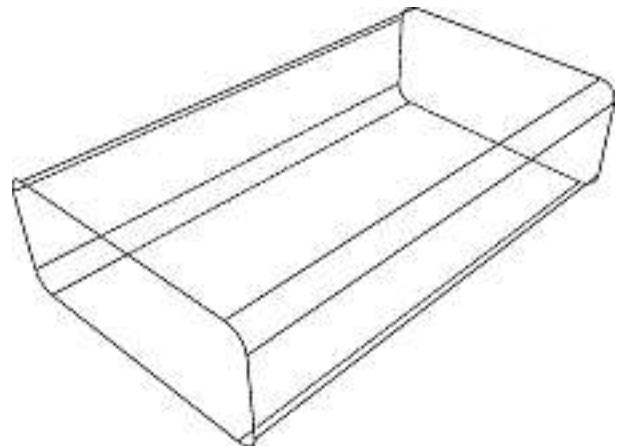

maho-Ladenausbau

**Verlängerungen  
Prolongations  
Prolongazioni**

119 140 Cl. 08-06 1 Design



1

119 457 Cl. 21-02 2 Design



400



2300

123 533	Cl.	25-02	1 Design
123 927	Cl.	02-06	2 Design
123 931	Cl.	07-04	1 Design
123 961	Cl.	06-04	1 Design
123 965	Cl.	07-04	2 Design
123 969	Cl.	09-03	1 Design
123 988	Cl.	21-01	1 design
124 018	Cl.	11-02	9 Design
124 076	Cl.	21-01	1 design
124 082	Cl.	22-01	1 Design
124 264	Cl.	20-02	9 Design
124 349	Cl.	15-99	1 Design
128 576	Cl.	06-06	2 Design
128 645	Cl.	07-01	1 Design
128 655	Cl.	10-04	1 Design
128 694	Cl.	07-05	1 Design
128 696	Cl.	10-04	1 design
128 709	Cl.	24-01	1 Design

128 710	Cl.	24-01	1 Design
128 711	Cl.	24-01	1 Design
128 712	Cl.	24-01	1 Design
128 718	Cl.	30-99	1 Design
128 779	Cl.	99-00	1 Design
128 805	Cl.	19-08	1 Design
128 852	Cl.	25-01	1 Design
128 855	Cl.	27-06	2 Design
128 858	Cl.	99-00	1 Design
128 944	Cl.	09-09	1 Design

**Löschungen  
Radiations  
Radiazioni**

119 093	Cl.	06-01	2 Design
119 134	Cl.	06-04	1 Design
119 146	Cl.	11-01	1 design
119 149	Cl.	14-02	1 Design
119 150	Cl.	14-02	1 Design
123 488	Cl.	10-02	1 Design
123 516	Cl.	06-03	1 Design
123 519	Cl.	07-01	3 Design
123 520	Cl.	07-02	2 Design
123 526	Cl.	13-03	1 Design
123 527	Cl.	15-05	1 Design
123 575	Cl.	24-04	1 Design
128 145	Cl.	06-01	1 design
128 149	Cl.	07-01	3 Design
128 153	Cl.	07-07	1 Design
128 165	Cl.	14-02	1 Design
128 168	Cl.	20-03	1 Design
128 184	Cl.	09-01	14 Design
128 185	Cl.	11-01	2 Design
128 186	Cl.	11-01	26 design
128 187	Cl.	12-11	1 Design
128 191	Cl.	26-05	2 Design
128 192	Cl.	26-05	1 Design
128 203	Cl.	10-04	2 design
128 248	Cl.	09-01	1 Design