

Nationale Hinterlegungen

In der folgenden Liste werden die beim Eidgenössischen Institut für Geistiges Eigentum hinterlegten Designs publiziert. Dabei sind der Reihe nach angegeben:

- internationale Klassenangaben
- Hinterlegungsnummer
- Hinterlegungsdatum
- Allenfalls Aufschub der Veröffentlichung
- Anzahl der hinterlegten Designs
- Bezeichnung
- Name und Wohnsitz des Hinterlegers oder der Hinterlegerin
- gegebenenfalls Name und Wohnsitz des Designers oder der Designerin
- Name und Geschäftssitz des allfälligen Vertreters oder der Vertreterin
- gegebenenfalls Prioritätsangaben
- gegebenenfalls Beschreibungstext
- Ordnungsnummer
- Reproduktion des Designs

Internationale Hinterlegungen

Die bei der Weltorganisation für geistiges Eigentum in Genf hinterlegten Muster und Modelle mit Benennung Schweiz geniessen den gleichen Schutz wie national hinterlegte Designs. Sie werden jeweils im Blatt «Bulletin des dessins et modèles internationaux» veröffentlicht. Dieses Publikationsorgan ist deshalb für eine vollständige Recherche unbedingt beizuziehen.

Topographien

Angaben über die vom Eidgenössischen Institut für Geistiges Eigentum eingetragenen Topographien von Halbleitererzeugnissen werden in folgender Anordnung aufgeführt:

- Eintragsnummer
- Anmeldedatum
- Bezeichnung
- Name und Wohnsitz des Anmelders oder der Anmelderin
- gegebenenfalls Name und Wohnsitz des Herstellers oder der Herstellerin
- Name und Geschäftssitz des oder der allfälligen Bevollmächtigten
- Datum und Ort einer allfälligen ersten geschäftlichen Verbreitung der Topographie

Dépôts nationaux

Les designs déposés à l'Institut Fédéral de la Propriété Intellectuelle sont publiés dans la liste qui suit. Les indications y relatives sont mentionnées dans cet ordre:

- indications des classes internationales
- numéro de dépôt
- date de dépôt
- le cas échéant, ajournement de la publication
- nombre des designs déposés
- désignation
- nom et domicile du/de la déposant/e
- le cas échéant, nom et domicile du/de la designer
- nom et domicile de l'éventuel/le mandataire
- le cas échéant, indication de priorité
- le cas échéant, description du design
- numéro attribué à chaque design
- reproduction du design

Dépôts internationaux

Les dessins et modèles déposés à l'Organisation Mondiale de la Propriété Intellectuelle à Genève qui désignent la Suisse jouissent de la même protection que les dépôts nationaux. Ils sont chaque fois publiés dans la feuille «Bulletin des dessins et modèles internationaux». Pour une recherche complète, il est indispensable de consulter ledit organe de publication.

Topographies

Les indications concernant les topographies des produits semi-conducteurs, enregistrées par l'Institut Fédéral de la Propriété Intellectuelle, sont énumérées dans l'ordre suivant:

- numéro d'enregistrement
- date de dépôt
- désignation
- nom et domicile du/de la déposant/e
- le cas échéant, nom et domicile du/de la producteur/trice
- nom et domicile de l'éventuel/le mandataire
- date et lieu d'une éventuelle première mise en circulation de la topographie

Depositi nazionali

Nella lista seguente vengono pubblicati i design depositati presso l'Istituto Federale della Proprietà Intellettuale. Sono menzionati nel seguente ordine:

- indicazioni delle classi internazionali
- numero di deposito
- data del deposito
- se del caso, indicazione che la pubblicazione è stata differita
- numero dei design depositati
- designazione
- nome e domicilio del depositante
- se del caso, nome e domicilio del designer
- nome e sede di un eventuale mandataro
- se del caso, indicazioni di priorità
- se del caso, descrizione del design
- numero d'ordine
- riproduzione del design

Depositi internazionali

I disegni e modelli depositati presso l'Organizzazione Mondiale della Proprietà Intellettuale a Ginevra con denominazione Svizzera godono della medesima protezione del deposito nazionale. Essi vengono pubblicati ogni volta nel foglio «Bulletin des dessins et modèles internationaux». Quest'organo di pubblicazione è da consultare se si vuole effettuare una ricerca completa.

Topografie

Le indicazioni concernenti le topografie di prodotti a semiconduttori depositati presso l'Istituto Federale della Proprietà Intellettuale sono menzionate nell'ordine seguente:

- numero di registrazione
- data del deposito
- designazione
- nome e domicilio del/la richiedente
- se del caso, nome e domicilio del/la produttore/trice
- nome e sede di un eventuale mandataro
- data e luogo di un'eventuale prima messa in circolazione della topografia

Hinterlegungen Dépôts Depositati

Cl. 09-03 130 529 01.04.2004
1 Design – Schachtel
Hinterleger: Roland Stahel, Forchstrasse 22, 8704 Herrliberg

Ende aufgeschobene Publikation



Schachtel

Cl. 01-03 132 540 07.02.2006
7 design – prodotti alimentari
Depositante: S.p.A. Egidio Galbani, Via Togliatti, 8, Melzo (Milano), IT
Designer: Gianfranco Mattei, Melzo
Mandatario: Jacobacci & Partners S.A., 1207 Genève
Priorità: EM, 08.08.2005

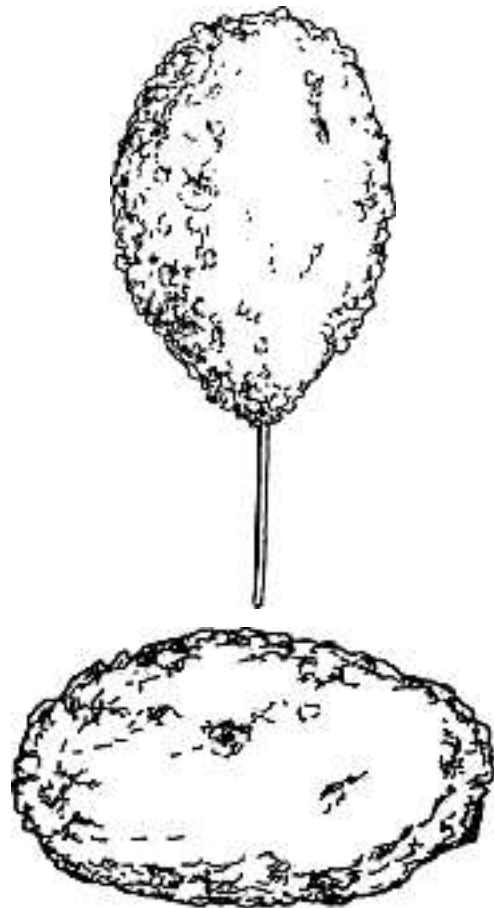

D-1990/06-S1

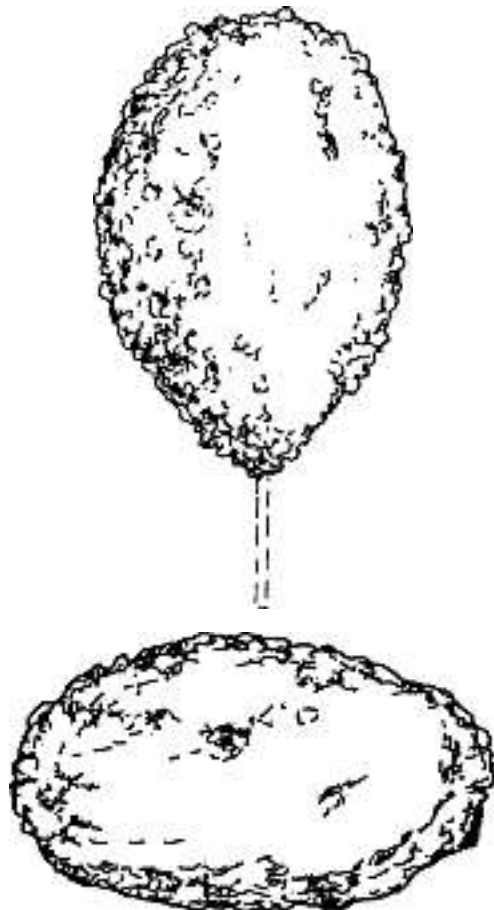

D-1990/06-S2

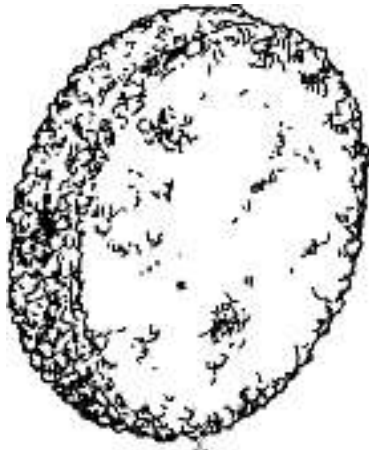

D-1990/06-S3

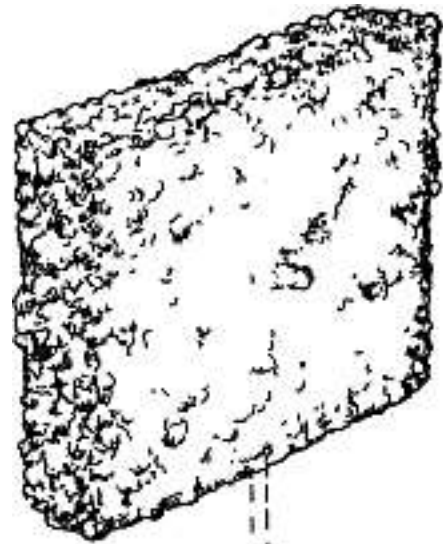

D-1990/06-S5

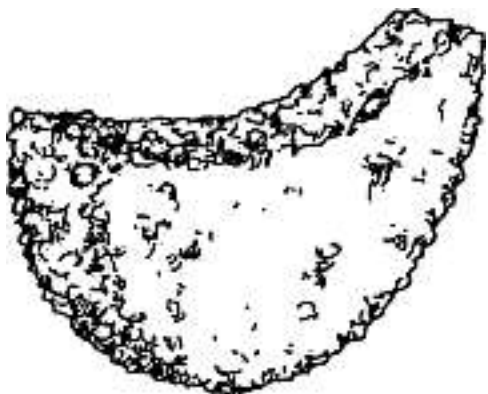

D-1990/06-S4

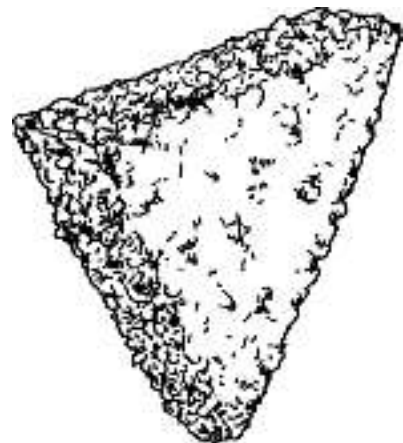

D-1990/06-S6

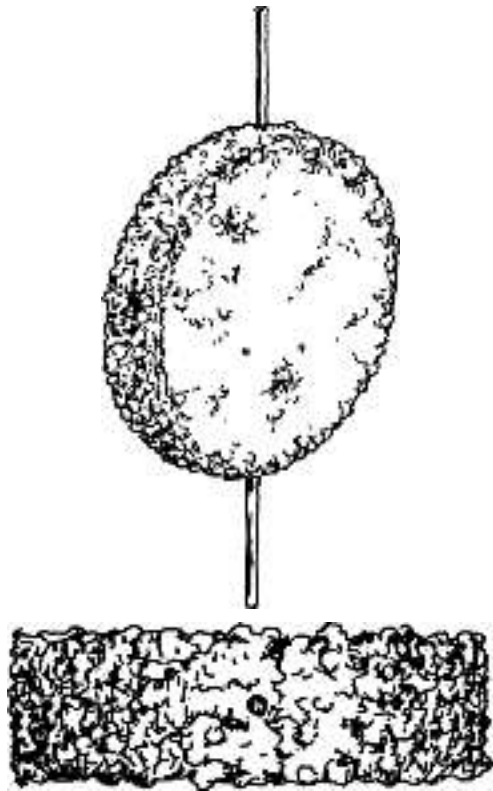

D-1990/06-S7

Cl. 02-07 132 541 08.02.2006
4 design – bouton de manchettes, boucle de ceinture, bouton de mercerie
Déposant: Fabien Ettori, Chemin de Plonjon 3, 1207 Genève
Mandataire: Griffes Consulting S.A., 1206 Genève

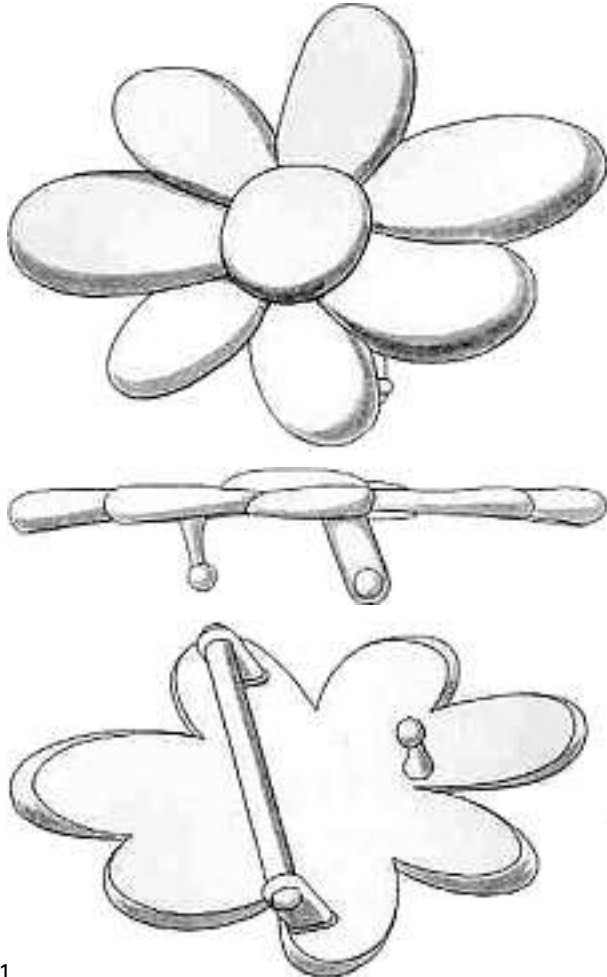

1



2

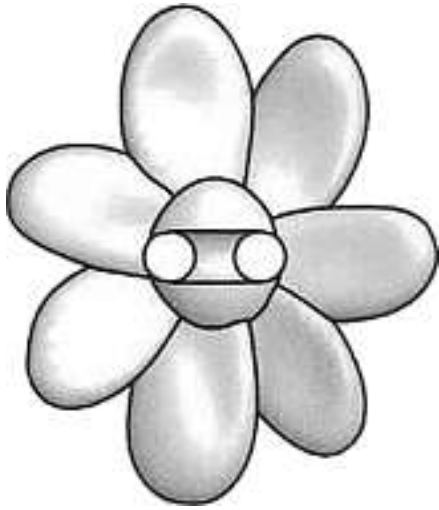

3

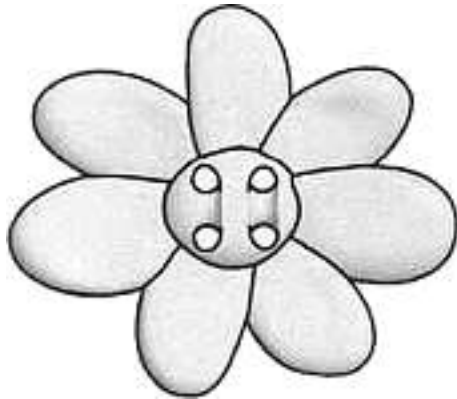
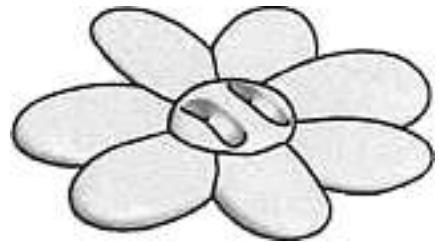

4

Cl. 03-01 132 542 10.01.2006
 2 Design – Portemonnaies
 Hinterleger: Stefanie Thalmann GmbH, Steinwiesstrasse 2,
 8032 Zürich
 Designer: Stefanie Thalmann, Zürich



Clam





Cid

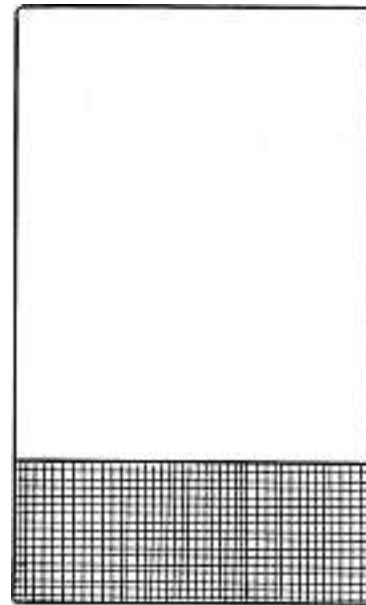
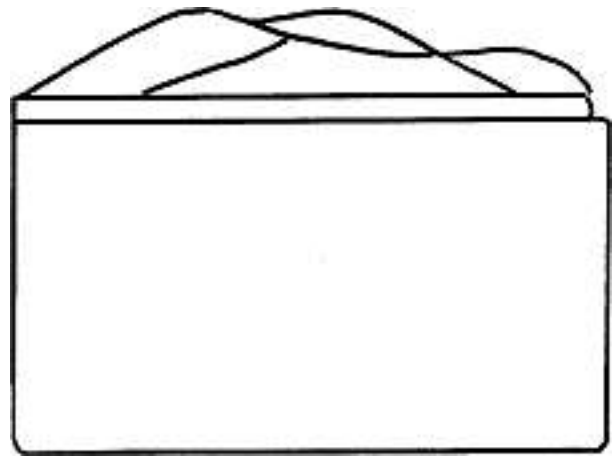

Mod.I

Cl. 03-01 **132 543** 16.01.2006
2 design – accessoire pour skis alpins
Déposant: Jean-Philippe Spelkens, Tenboslaan 1,
Hoeilaart, BE
Mandataire: Caroline Fabian, 4105 Biel-Benken BL

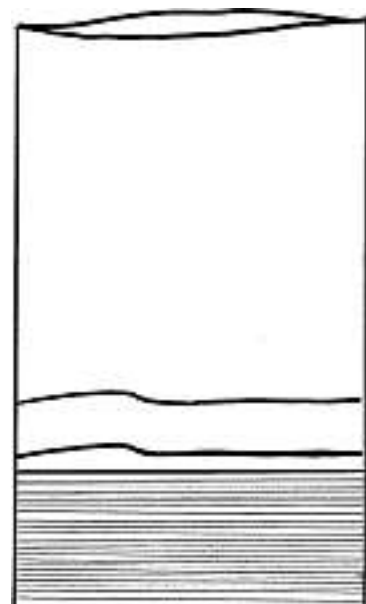
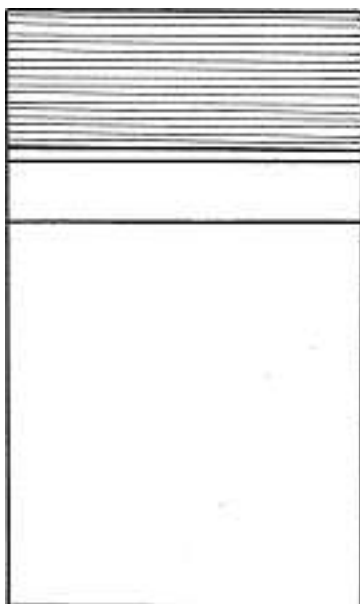

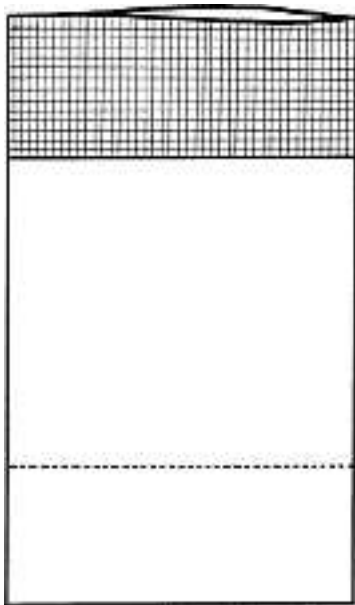
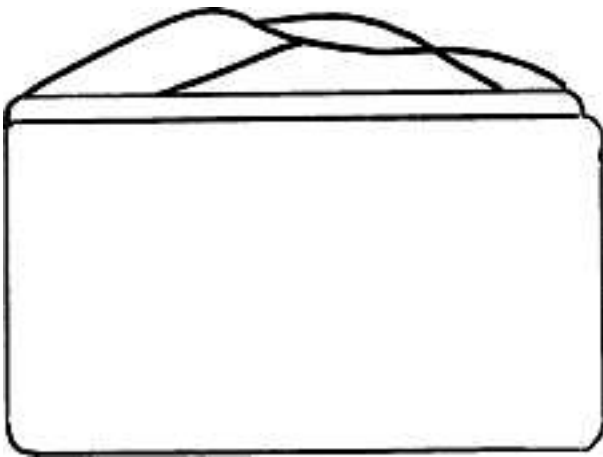

Mod.II

Cl. 03-03 **132 544** 01.02.2006
 3 Design – Schirmaufspannschieber, Schirmgriffe
 Hinterleger: Knirps Licence Corporation GmbH & Co. KG,
 Lindner Strasse 19, Pfarrkirchen, DE
 Designer: Knut Schröder, Rösrath; Bernhard Rothbacher,
 Salzburg
 Vertreter: Patentanwaltsbüro Dr. Urs Falk, 6312 Steinhausen



D8CH.1

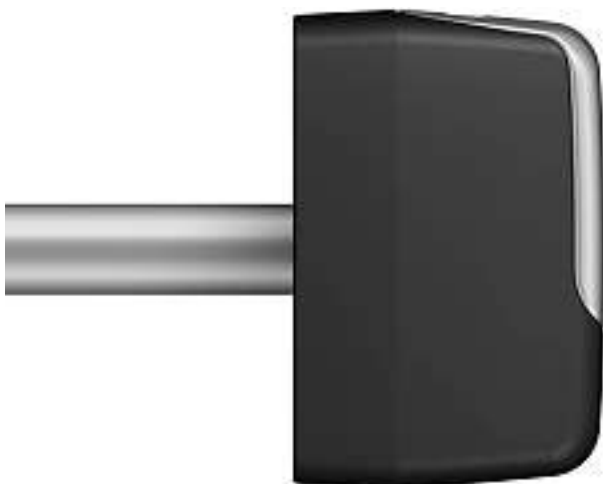

D8CH.2



D8CH.3

Cl. 06-01, 06-03 132 545 27.12.2005
 2 Design – Tisch, Bank
 Hinterleger: Forstdienste Lenzia, Burghaldenstrasse 59,
 Postfach, 5600 Lenzburg 2
 Designer: Hannes Furger, Möriken-Wildegg



1



2

Cl. 06-01, 06-03 132 546 18.01.2006
 3 Design – Sitzbank, Tisch
 Hinterleger: Mobimex AG, Birren 19, 5703 Seon
 Designer: Walter Zwick, Seon



BanX



HARP- Tisch



Bogenwangen- TIX

Cl. 06-01 132 547 30.01.2006
 21 design – sièges-puzzles
 Déposant: Joëlle Carrupt, Rue de Lavetan 10, 1912 Leytron
 Mandataire: Cabinet Roland Nithardt, Conseils en Propriété
 Industrielle SA, 1400 Yverdon-les-Bains

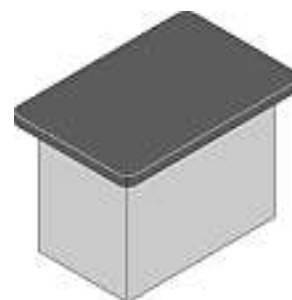

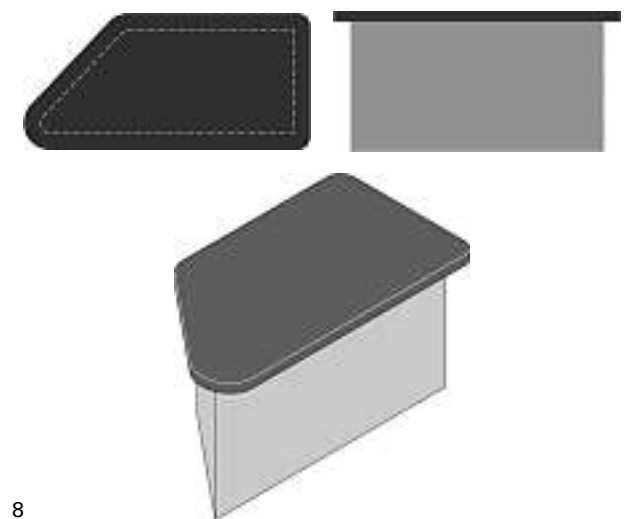
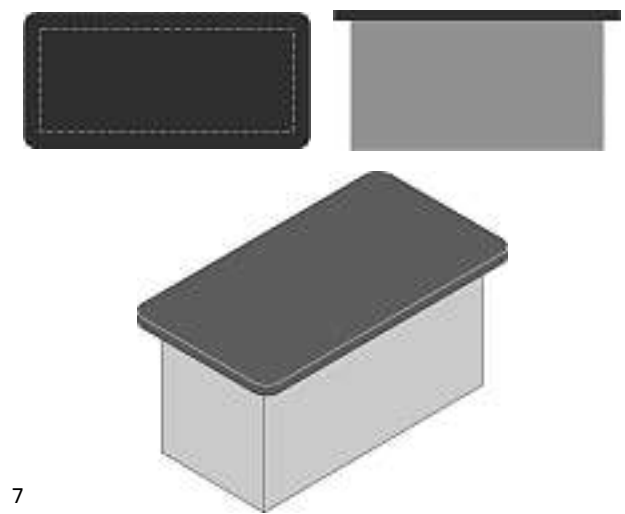
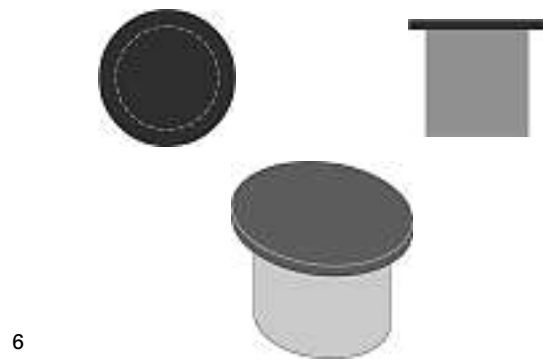
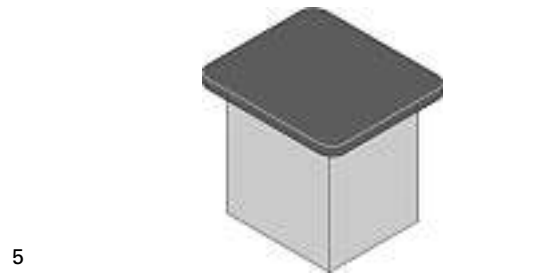
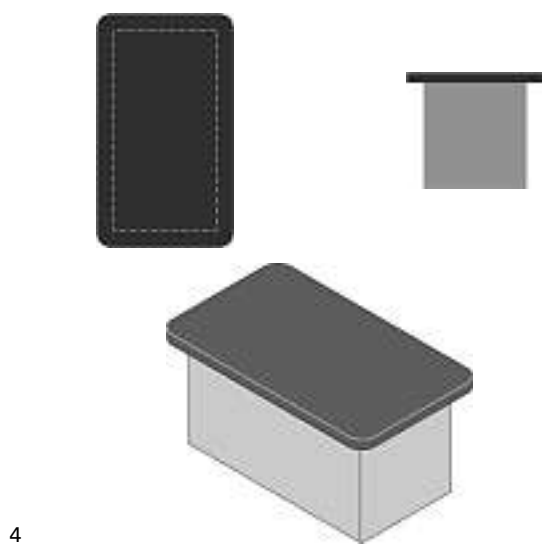
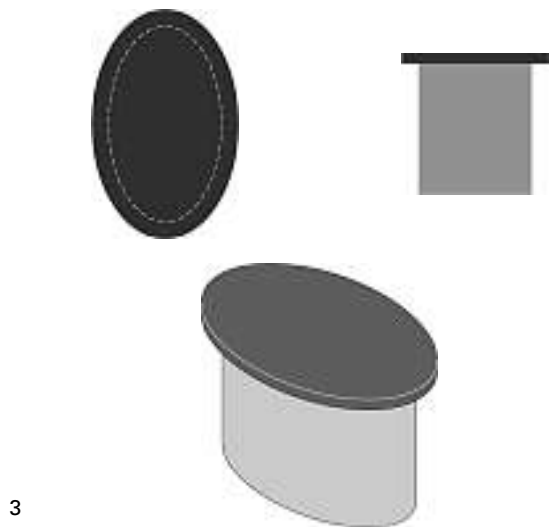
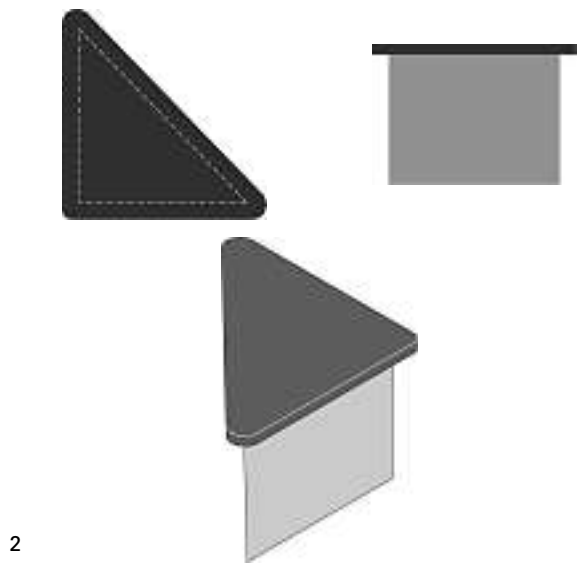

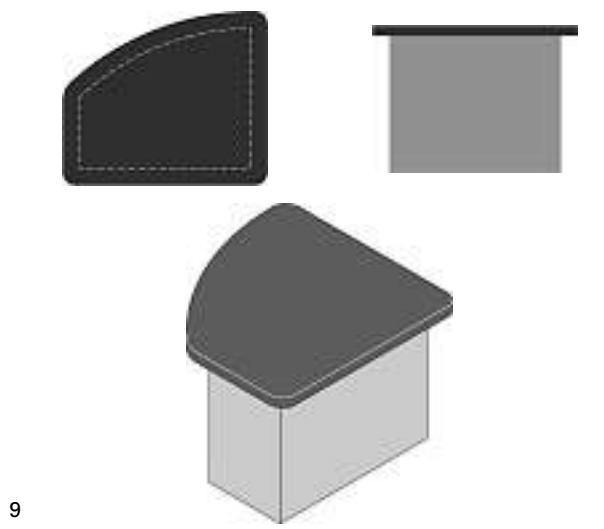

9

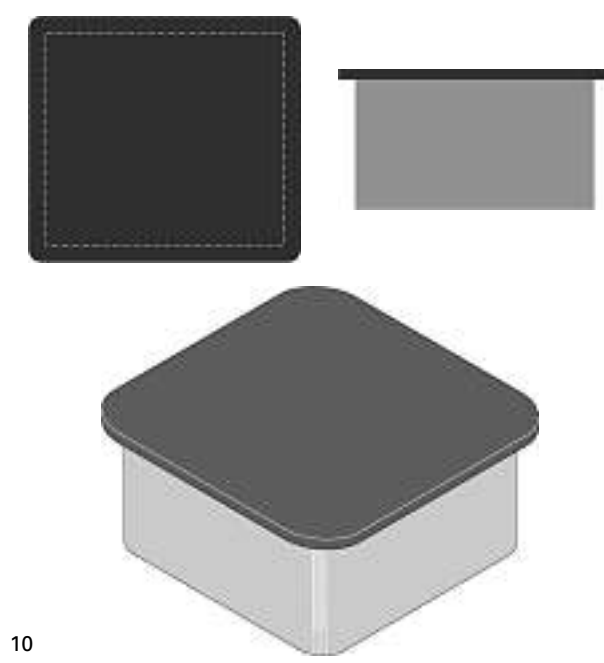

10

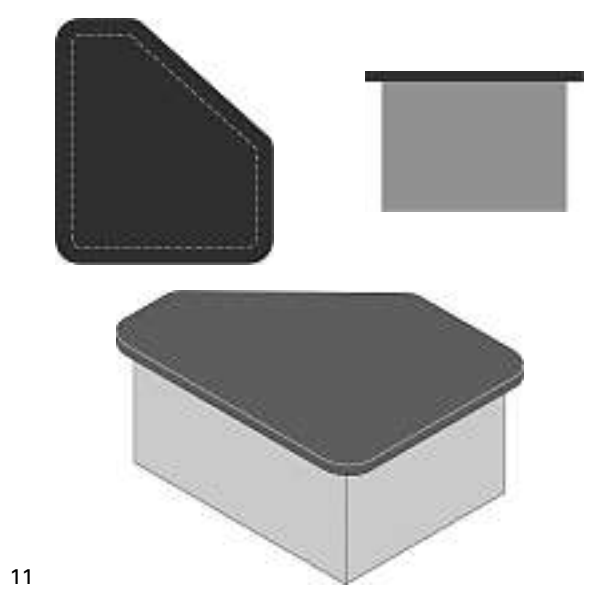

11

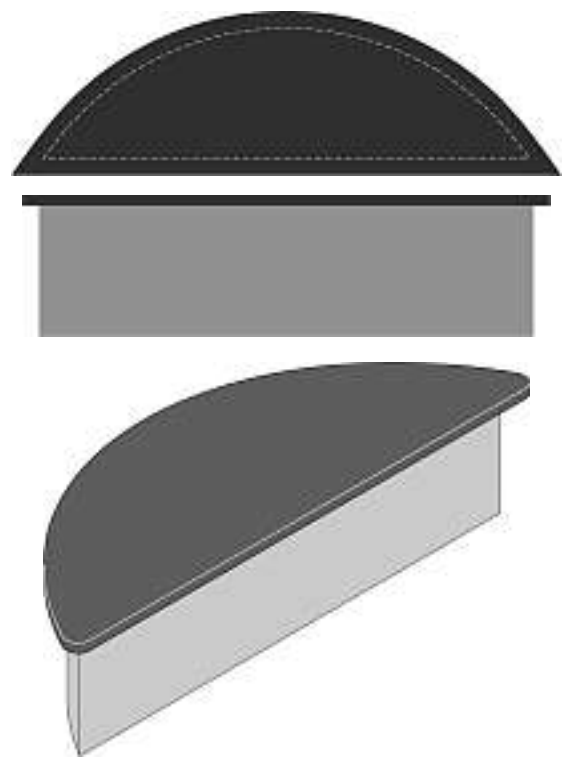

12

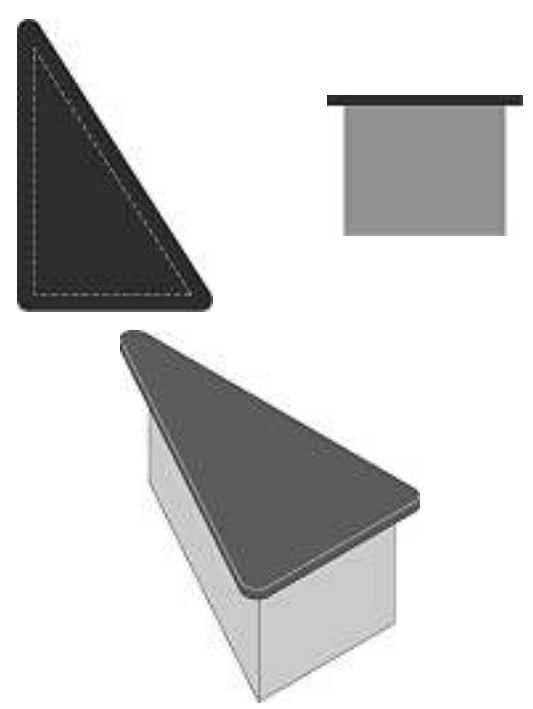

13

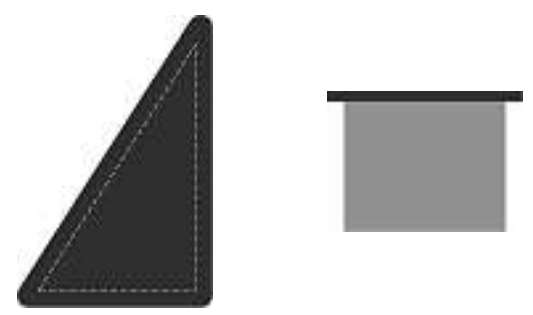

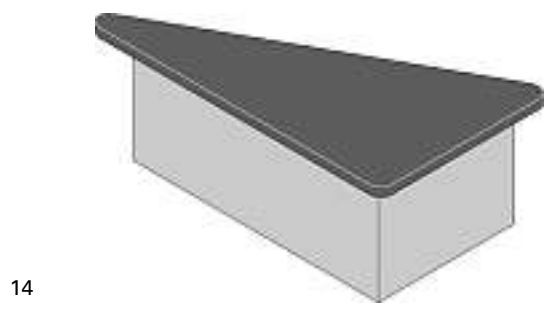

14



15

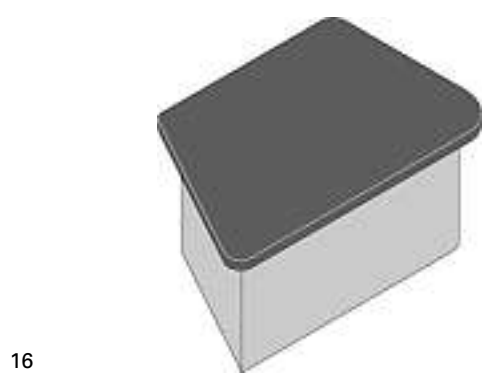

16

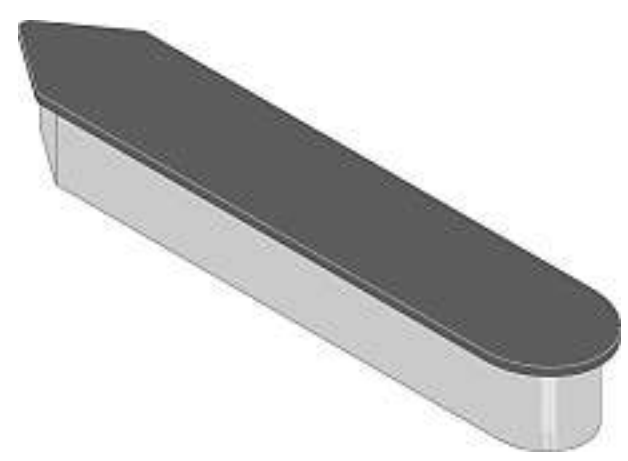

17

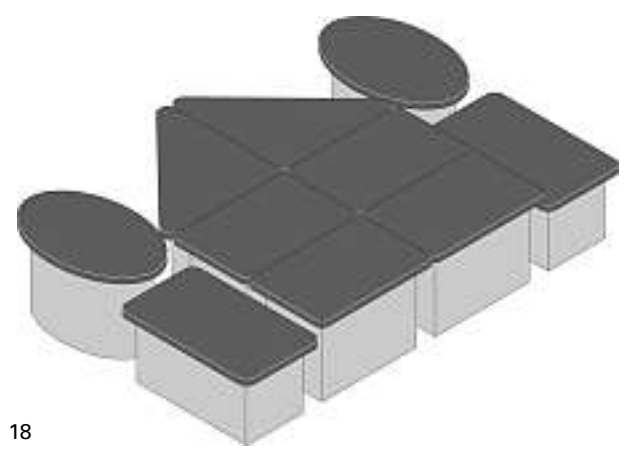
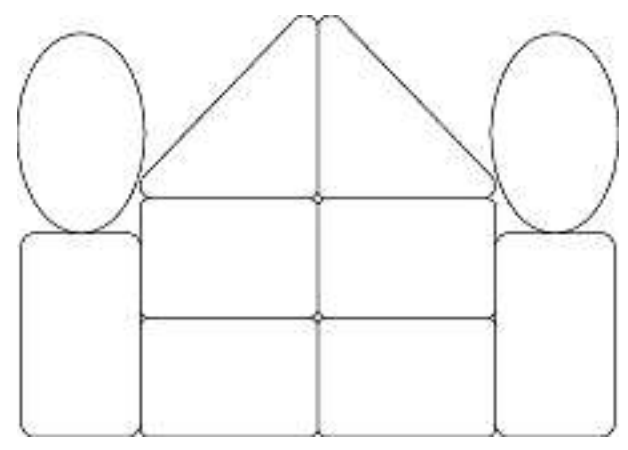

18

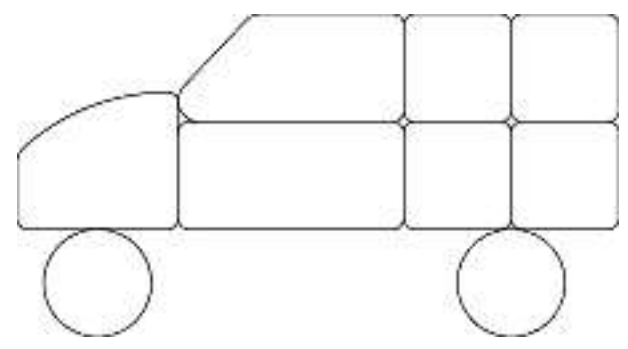

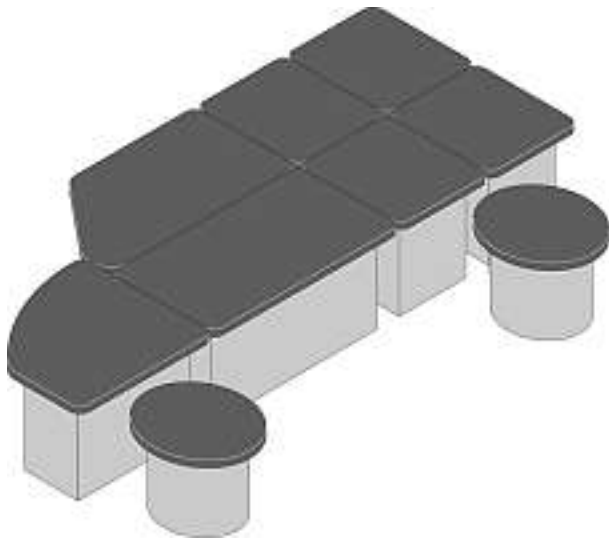

19

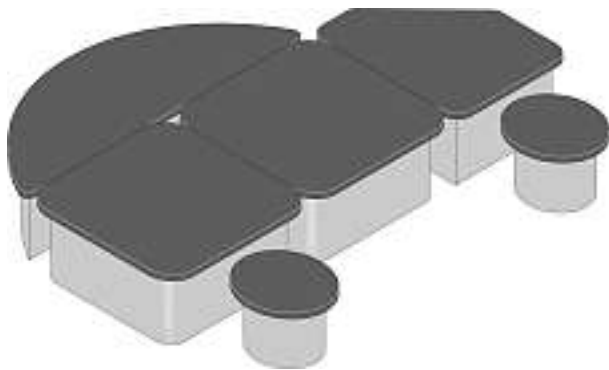
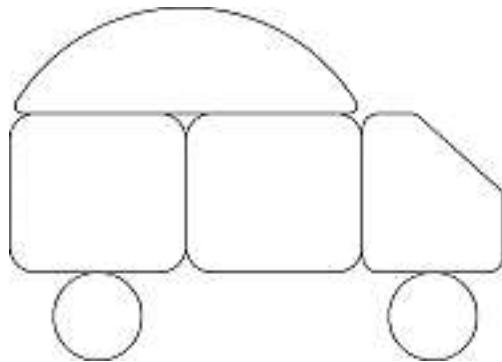

20

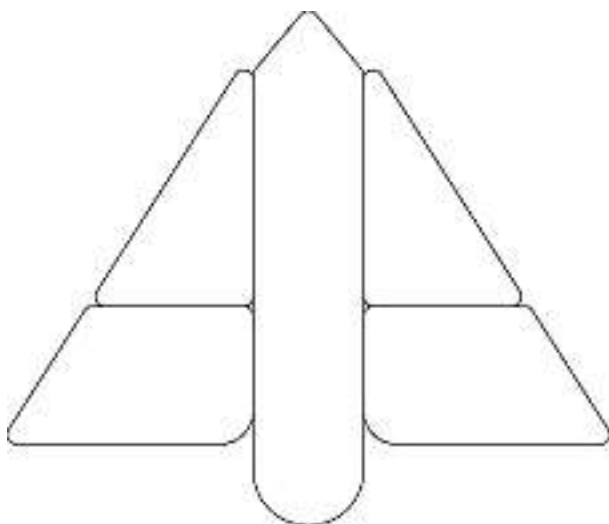

21

Cl. 06-01 132 548 06.02.2006
 1 Design – Licht-Bank
 Hinterleger: Francesco Mariotti, Haeringstrasse 14,
 8001 Zürich



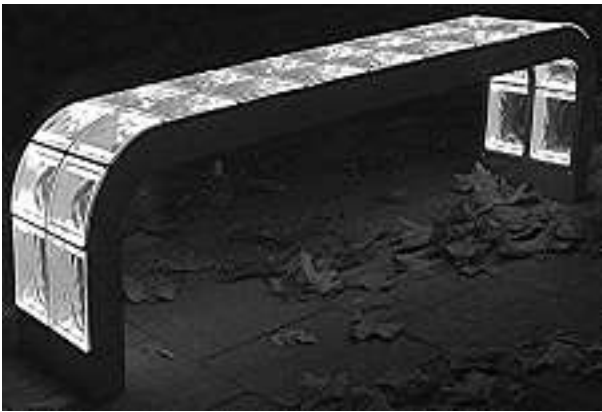

L-K-B

Cl. 06-01 132 549 13.02.2006
 5 Design – Polstermöbel
 Hinterleger: Rolf Benz AG & Co. KG,
 Haiterbacher Strasse 104, 72202 Nagold, DE
 Designer: Christian Werner, Hollenstedt/Appel
 Vertreter: Bovard AG, 3000 Bern 25
 Priorität: EM, 14.09.2005



1



2



3



4



5

Cl. 06-01, 06-03, 06-11 132 550 14.02.2006
 22 Design – Polstermöbel, Tisch, Teppich
 Hinterleger: Rolf Benz AG & Co. KG,
 Haiterbacher Strasse 104, 72202 Nagold, DE
 Designer: Joachim Nees, Schöllkrippen; Michael Heinrich,
 Nagold; Christian Werner, Hollenstedt/Appel; Norbert Beck,
 Markdorf; Edgar Reuter, Donzdorf; Petra Stützel, Nagold;
 Werner Baumhackl, Seon
 Vertreter: Bovard AG, 3000 Bern 25
 Priorität: EM, 06.10.2005; EM, 06.10.2005; EM, 06.10.2005;
 EM, 06.10.2005; EM, 06.10.2005; EM, 06.10.2005; EM,
 06.10.2005; EM, 06.10.2005; EM, 06.10.2005; EM, 06.10.2005;
 EM, 06.10.2005; EM, 06.10.2005; EM, 06.10.2005; EM,
 06.10.2005; EM, 06.10.2005; EM, 06.10.2005; EM, 06.10.2005;
 EM, 06.10.2005; EM, 06.10.2005; EM, 06.10.2005; EM,
 06.10.2005; EM, 06.10.2005; EM, 06.10.2005



1



2



3



4



5



6

7



8



9



10



11





12



13



14



15



16



17



18



19



20



21

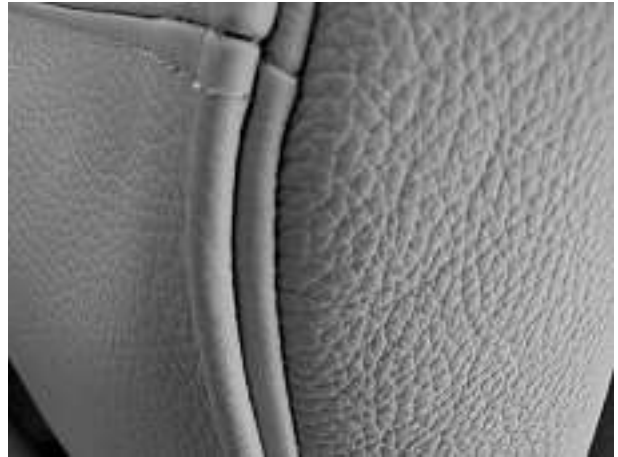

22

Cl. 06-03 132 551 25.01.2006
 1 Design – Tisch
 Hinterleger: Daniel Zuckschwert, Zopfstrasse 103,
 5708 Birrwil



Typ Bahia

Cl. 06-04 132 552 20.01.2006
 1 Design – Schubkasten mit Griff- und Halteschlaufen
 Hinterleger: Artoz-Papier AG, Ringstrasse West 23,
 5600 Lenzburg
 Designer: Hans-Albert Kufferath, Lenzburg
 Vertreter: PPS Polyvalent Patent Service AG, 8954 Geroldswil





MOD-26/01.03

Cl. 06-04 **132 553** 27.01.2006
 6 Design – Schubladenmöbel, Kastenmöbel
 Hinterleger: Henk Sikken, Seemattstrasse 1, 6330 Cham

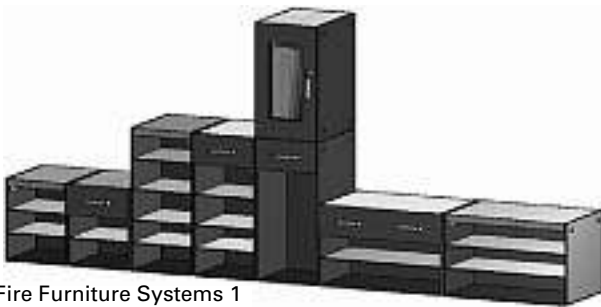

Fire Furniture Systems 1



Fire Furniture Systems 2

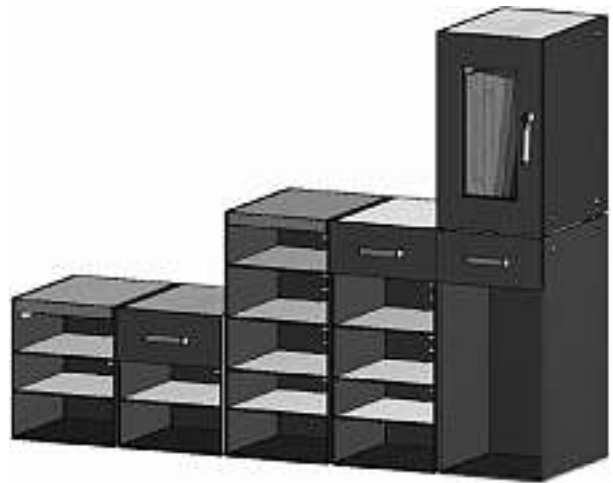

Fire Furniture Systems 3



Fire Furniture Systems 4



Fire Furniture Systems 5



Fire Furniture Systems 6

2



3



Cl. 06-04 **132 554** 30.01.2006
 3 Design – Spender
 Hinterleger: Philipp Hänger, Postfach 2953, 5000 Aarau;
 Philipp Gilgen, Arlesheimerstrasse 15, 4053 Basel
 Vertreter: Philipp Gilgen, 4053 Basel

Cl. 08-08 **132 555** 20.01.2006

1 Design – Griff- und Halteschlaufe
 Hinterleger: Artoz-Papier AG, Ringstrasse West 23,
 5600 Lenzburg
 Designer: Hans-Albert Kufferath, Lenzburg
 Vertreter: PPS Polyvalent Patent Service AG, 8954 Geroldswil
 Beschreibung des Designs: Eine Griff- und Halteschlaufe aus
 einem Material mit lederartiger Struktur weist einen zentralen
 Knopf auf. Die Schlaufe ist an diesem Knopf befestigt.
 Vorzugsweise ist die Oberflächenstruktur des zu öffnenden
 und/oder zu haltenden Gegenstands auf die Struktur der
 Schlaufe abgestimmt bzw. vice versa.



MOD-26/01.01

1

Cl. 08-08 **132 556** 03.02.2006
 1 Design – Dichtungsring für Schnellkupplung
 Hinterleger: FASTER S.p.A., Via L. Ariosto, 7 - Zona Industriale,
 26027 Rivolta d'Adda (Cr), IT
 Designer: Massimo Arosio, Treviglio
 Vertreter: Frei Patentanwaltsbüro, 8032 Zürich
 Priorität: IT, 05.08.2005

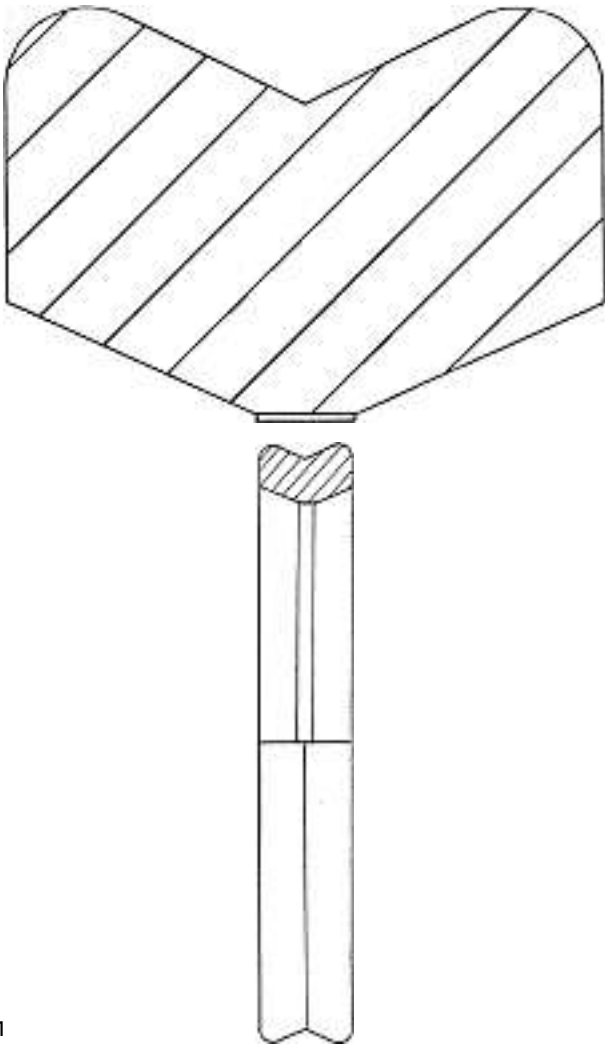

Cl. 09-03 **132 557** 20.01.2006
 1 Design – Schachtel mit Griff- und Halteschlaufe
 Hinterleger: Artoz-Papier AG, Ringstrasse West 23,
 5600 Lenzburg
 Designer: Hans-Albert Kufferath, Lenzburg
 Vertreter: PPS Polyvalent Patent Service AG, 8954 Geroldswil



MOD-26/01.02

Cl. 09-05 **132 560** 13.02.2006
 1 Design – Verpackungsbeutel
 Hinterleger: Elsaesser Verpackungen AG, Industrie Neuhof,
 3422 Kirchberg BE
 Designer: Robert Elsaesser, Burgdorf
 Vertreter: Bovard AG, 3000 Bern 25
 Beschreibung des Designs: Der Serviettenbeutel umfasst auf
 der Vorderseite zwei Öffnungen: Eine obere geschwungene
 Öffnung für eine aus dem Beutel herausragende Serviette
 und eine darunter liegende zweite Öffnung für einsteckbares
 Besteck.

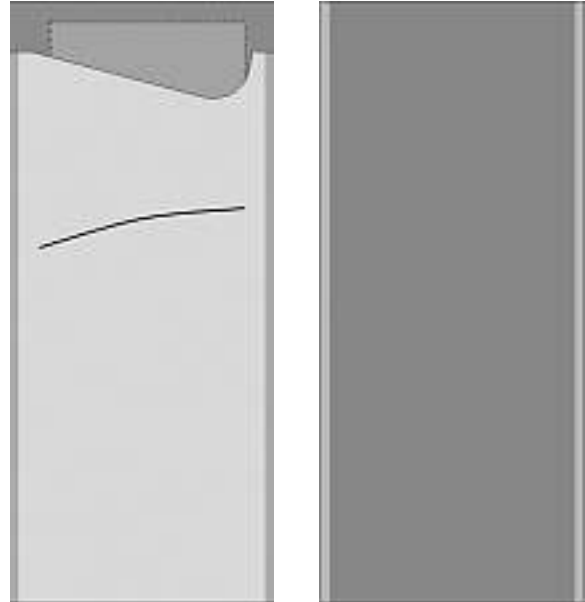

1

Cl. 11-01 **132 563** 08.02.2006
 5 design – bague, élément décoratif pour bijou, élément
 décoratif pour bracelet et collier
 Déposant: Fabien Ettori, Chemin de Plonjon 3, 1207 Genève
 Mandataire: Griffes Consulting S.A., 1206 Genève



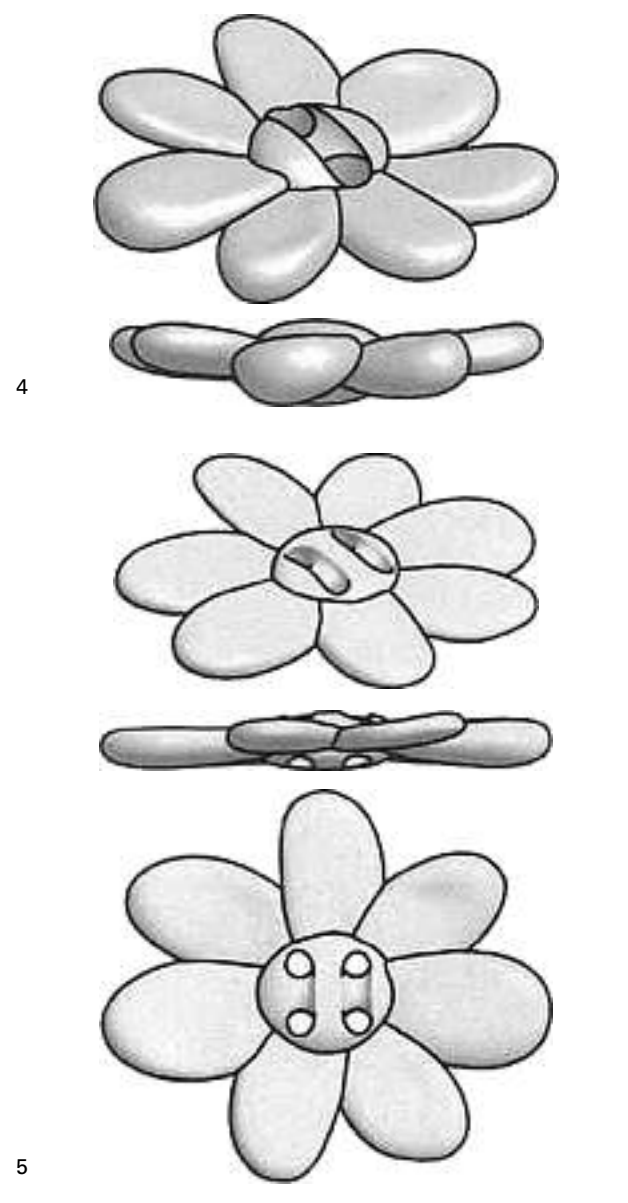
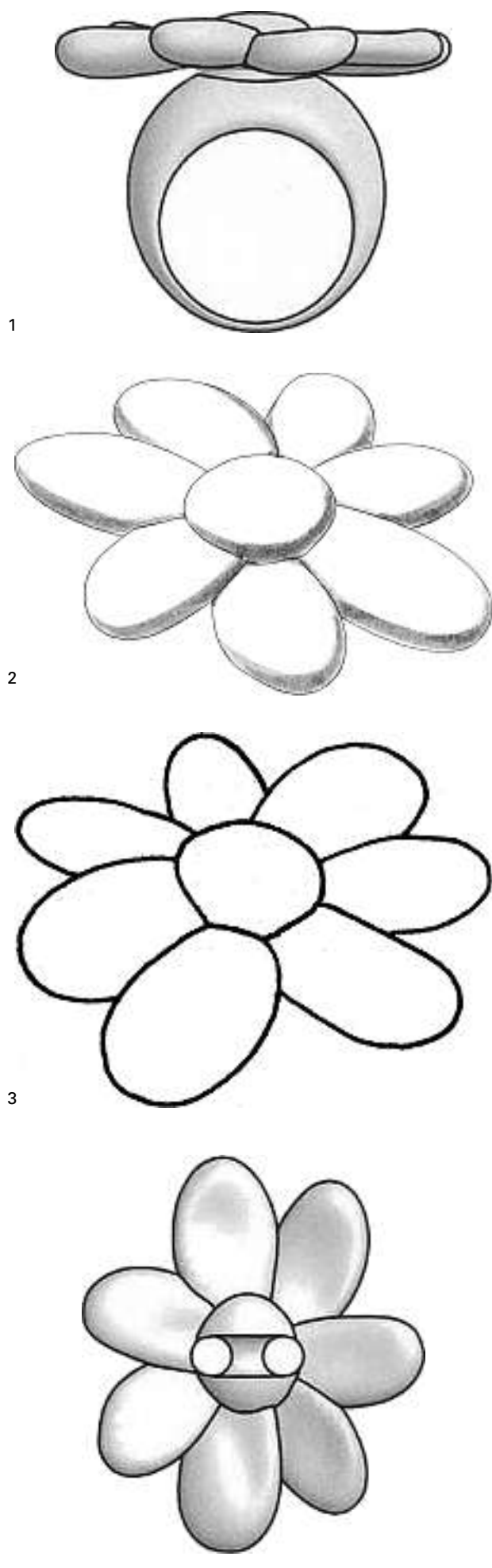

Cl. 11-02 132 564 13.01.2006
20 Design – Ziergegenstände
Hinterleger: Schlittler & Co. AG, Franzosenstrasse,
6423 Seewen SZ
Designer: Markus Völkle, Gersau; Bruno Camenzind, Gersau



41782



41759.0

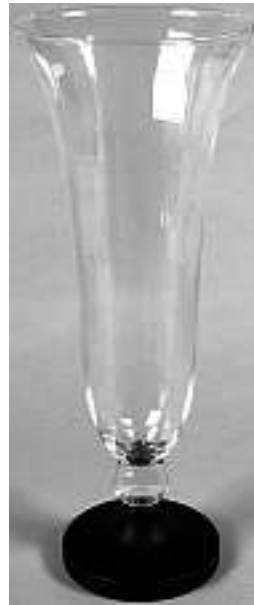

41766.0



41779



41770.0



41776.0



41780



41757.0



41784



41785



41786



41787



41667



41763.0



41670



41768.0



41681



41682.0



41689



41690.0



45911



45912



45914

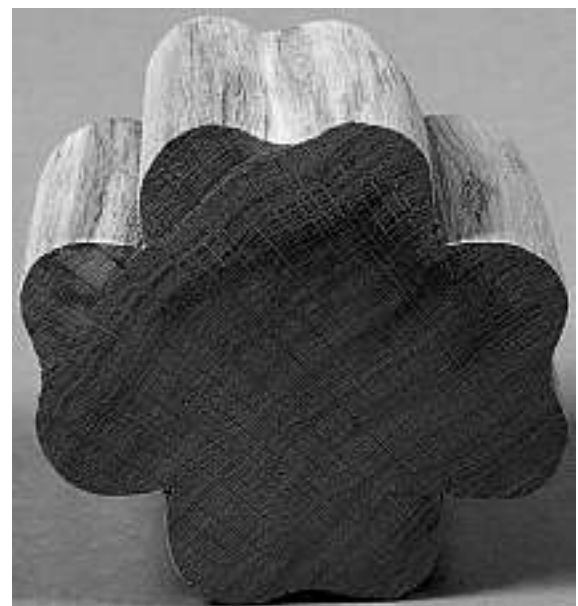

45815

Cl. 11-02 132 565 13.01.2006
 6 Design – Ziergegenstände
 Hinterleger: Schlittler & Co. AG, Franzosenstrasse,
 6423 Seewen SZ
 Designer: Stuart A. Glückstein, Stetten

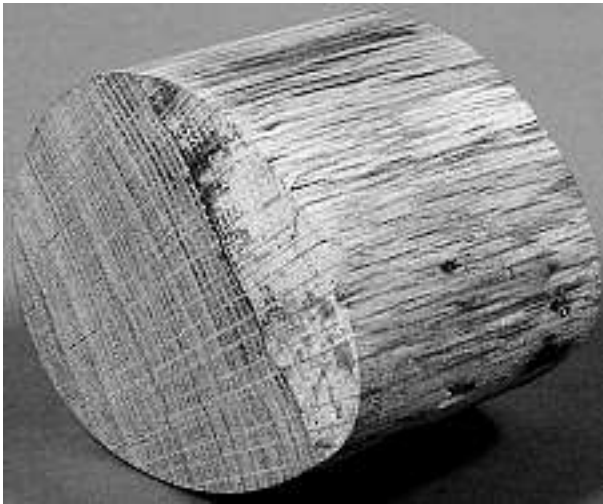

45812



36194

Cl. 13-03 132 566 09.02.2006
 1 design – connecteur
 Déposant: Bien-Air Holding SA, Länggasse 60, 2504 Bienne
 Designer: Marc Tosetti, Cortailod
 Mandataire: INFOSUISSE, Information Horlogère et Industrielle, 2302 La Chaux-de-Fonds

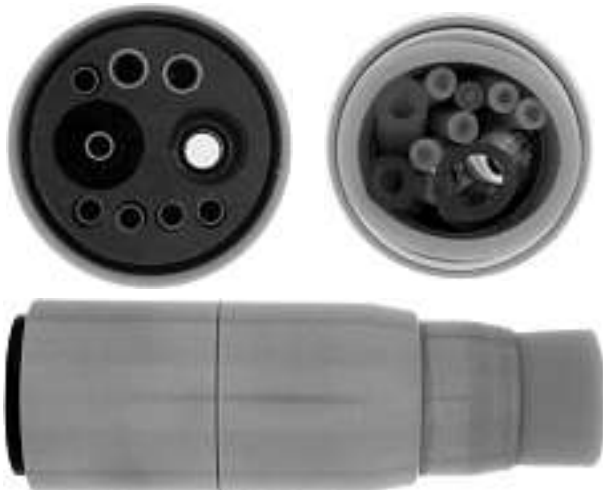

1

Cl. 14-03 132 567 16.02.2006
 1 Design – Fernbedienung
 Hinterleger: BSH Bosch und Siemens Hausgeräte GmbH, Carl-Wery-Strasse 34, München, DE
 Designer: Jörg Schröter, Gröbenzell
 Vertreter: Isler & Pedrazzini AG, 8023 Zürich
 Priorität: EM, 29.08.2005



M13126

Cl. 15-05 **132 568** 16.02.2006
 1 Design – Staubsaugerroboter
 Hinterleger: BSH Bosch und Siemens Hausgeräte GmbH,
 Carl-Wery-Strasse 34, München, DE
 Designer: Jörg Schröter, Gröbenzell
 Vertreter: Isler & Pedrazzini AG, 8023 Zürich
 Priorität: EM, 29.08.2005



M13125

Cl. 15-05 **132 569** 16.02.2006
 1 Design – Anzeige-/Eingabefeld
 Hinterleger: BSH Bosch und Siemens Hausgeräte GmbH,
 Carl-Wery-Strasse 34, München, DE
 Designer: Jörg Schröter, Gröbenzell
 Vertreter: Isler & Pedrazzini AG, 8023 Zürich
 Priorität: EM, 29.08.2005





M13128

Cl. 15-05 132 570 16.02.2006
 1 Design – Ladestation
 Hinterleger: BSH Bosch und Siemens Hausgeräte GmbH,
 Carl-Wery-Strasse 34, München, DE
 Designer: Jörg Schröter, Gröbenzell
 Vertreter: Isler & Pedrazzini AG, 8023 Zürich
 Priorität: EM, 29.08.2005



M13129

Cl. 17-03 132 571 16.01.2006
 2 design – parties de guitares
 Déposant: Frédéric Quartier, route de Gossens, 1413 Orzens

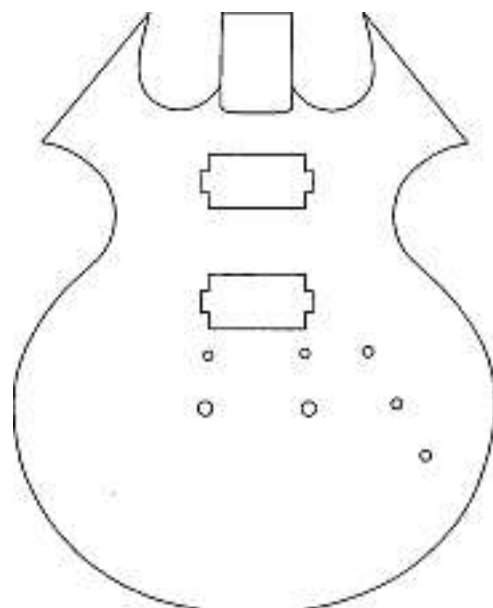

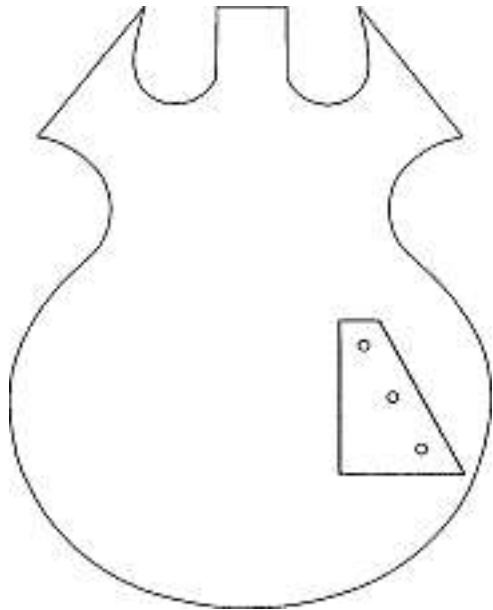

PNR_body_standard



PNR_head_standard



F1

Cl. 19-08 132 573 08.02.2006

7 design – dessins pour imprimés
Déposant: Videotop Productions, Jean-Daniel Rudaz,
rue des Aubépinés 11, 1950 Sion
Designer: Jean-Daniel Rudaz, Sion



Dream towers



Dream shrooms

Cl. 19-08 132 572 07.02.2006
1 Design – Druckvorlage
Hinterleger: Beat Walmer, Im Fluhblick 7, 4441 Thürnen
Designer: Edgar Muriset, Tenniken

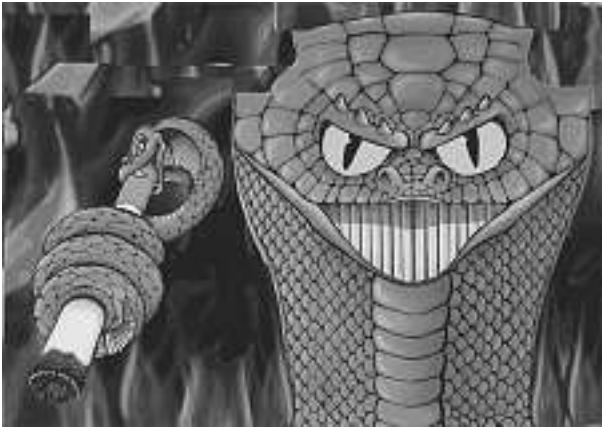

Green snake



Dragon



Paris



Covergirls



Lady Covergirls

Cl. 19-99 **132 574** 07.02.2006

1 Design – Buchzeichen/Büroklammer
 Hinterleger: Team HP Schneider AG für Gestaltung,
 Alpstrasse 4, 8352 Rätterschen
 Designer: Hanspeter Schneider, Rätterschen



2131

Cl. 21-01 **132 575** 20.12.2005

4 Design – Puzzles
 Hinterleger: BSZ Stiftung, Hausmatt 9, 6423 Seewen SZ
 Designer: Daniela Matter-Hunziker, Luzern



Zauberfee



Lastwagen



Haus IGarten



Elefant

Cl. 21-01 132 576 01.02.2006
 2 design – cartes de jeu
 Déposant: Antonio Leoni, rue de Locle 5A,
 2300 La Chaux-de-Fonds

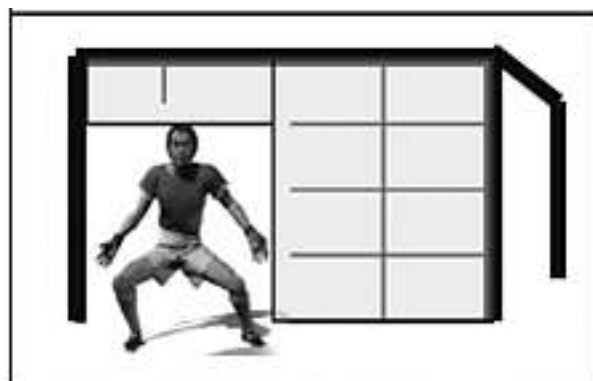

Gardien

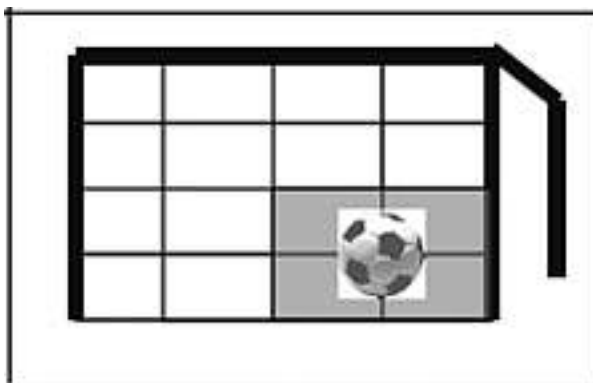

Tir

Cl. 23-03 132 577 06.01.2006
 2 design – panneaux solaires
 Déposant: SOL-R-TEC Bezençon & Sugnaux,
 Route du Burenz 23, 1092 Belmont-sur-Lausanne
 Designer: François Sugnaux, Blonay; François Calame,
 Bougy-Villars; Bernard Bezençon, Belmont-sur-Lausanne

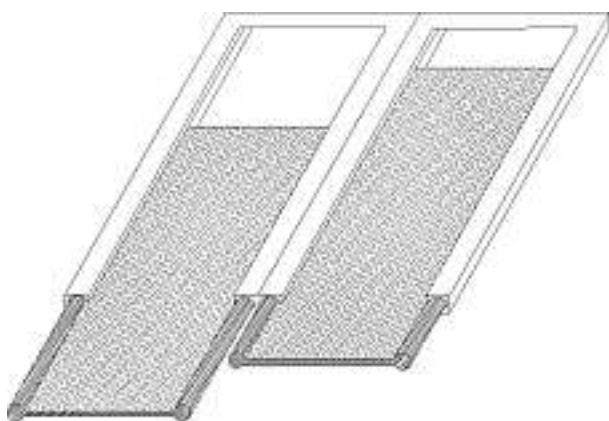

SOL-R-TEC 1

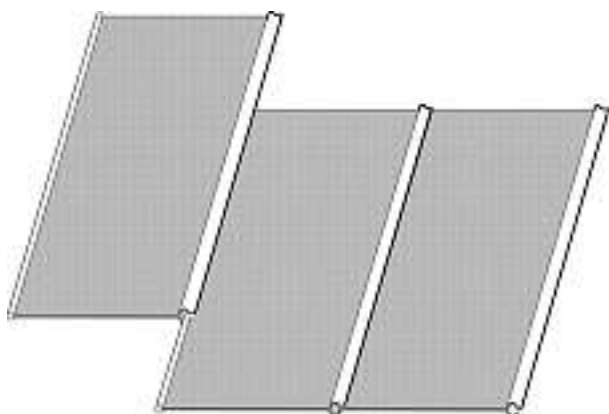

SOL-R-TEC 2

Cl. 23-03 132 578 09.02.2006
 10 Design – Heizkörper
 Hinterleger: Runtal Holding Company S.A., Moortalstrasse 1,
 5722 Gränichen
 Designer: Patrick Noga, Etreillers
 Vertreter: E. Blum & Co., 8044 Zürich
 Priorität: EM, 11.08.2005

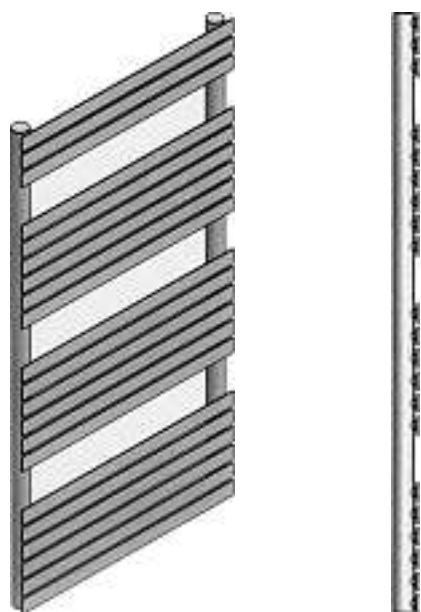

A

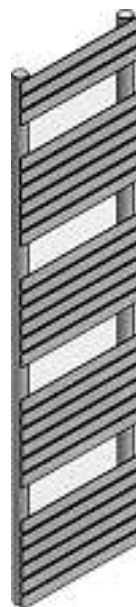

B



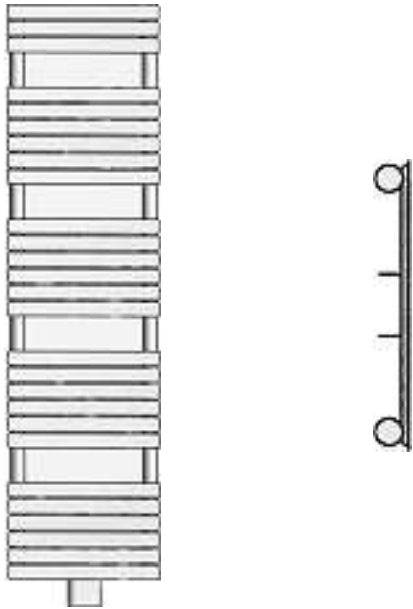
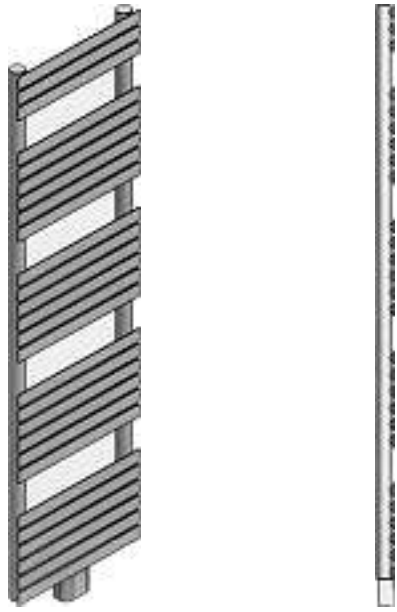

C

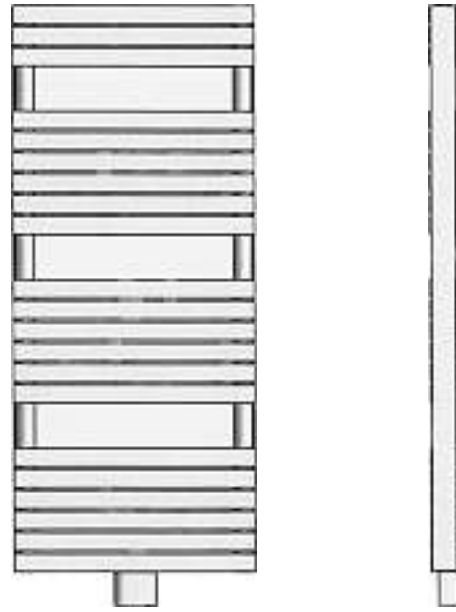
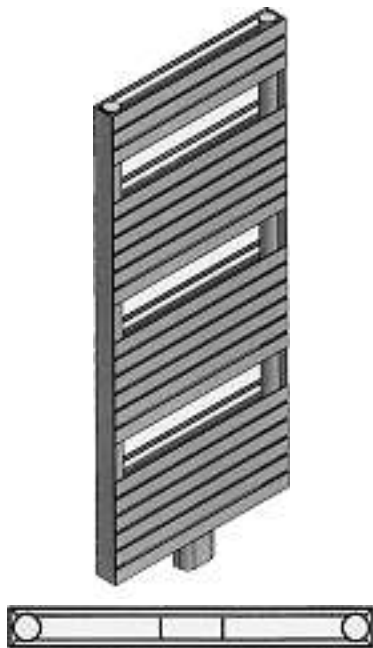

D



E

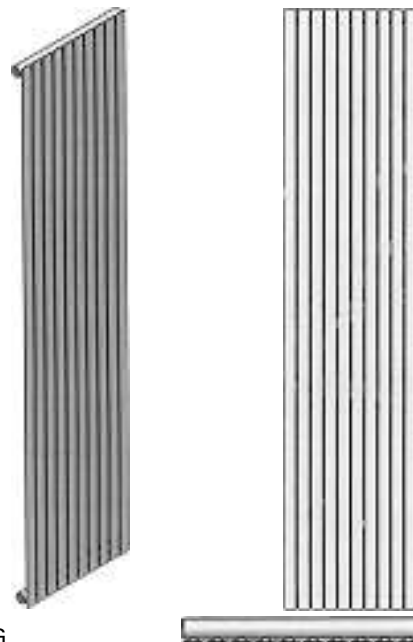

G



F

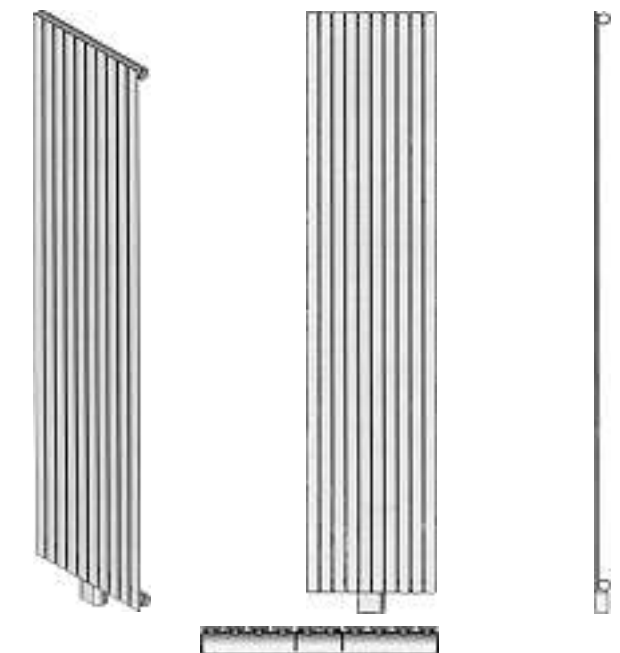

H

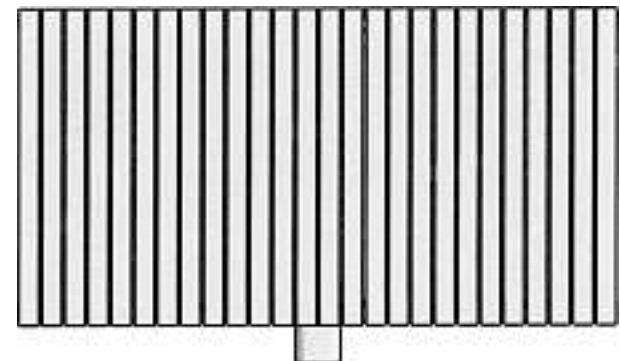
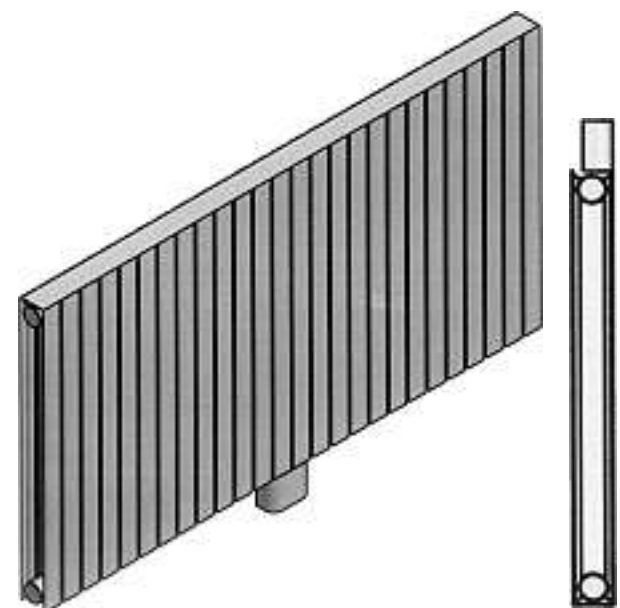

J

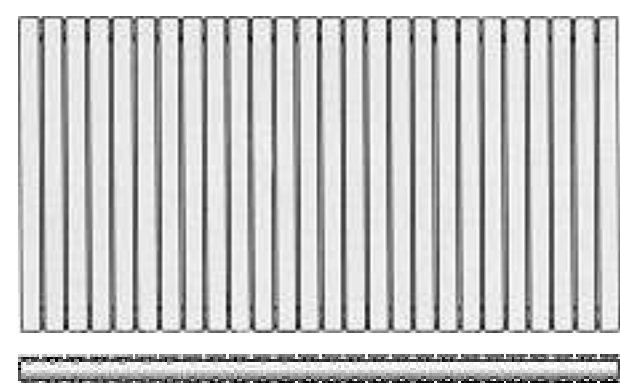
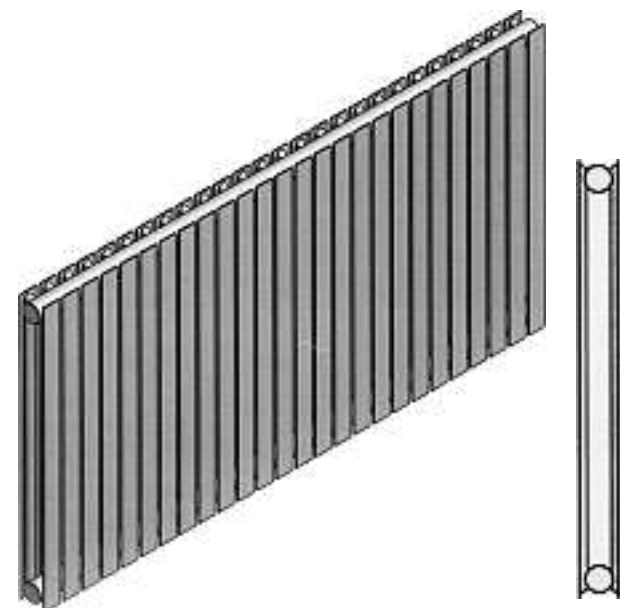

I



Cl. 25-02 **132 579** 10.02.2006
 1 design – porte d'entrée
 Déposant: Pascal Oggier, route de Delémont 20,
 2830 Courrendlin



1

Cl. 26-04 **132 580** 17.01.2006
 1 Design – Maschinenleuchte
 Hinterleger: Herbert Waldmann GmbH & Co. KG,
 Peter-Henlein-Strasse 5, 78056 Villingen-Schwenningen, DE
 Designer: Gerhard Waldmann, Dauchingen
 Vertreter: R. A. Egli & Co., Patentanwälte, 8008 Zürich
 Priorität: DE, 20.09.2005





1

Cl. 26-05 **132 581** 20.01.2006
4 Design - Beleuchtungsapparate und deren Bestandteile
Hinterleger: iGUZZINI ILLUMINAZIONE S.p.A.,
Via Mariano Guzzini 37, Recanati, Macerata, IT
Designer: Giannunzio Guzzini, Recanati
Vertreter: Bovard AG, 3000 Bern 25
Priorität: EM, 02.08.2005



1



2

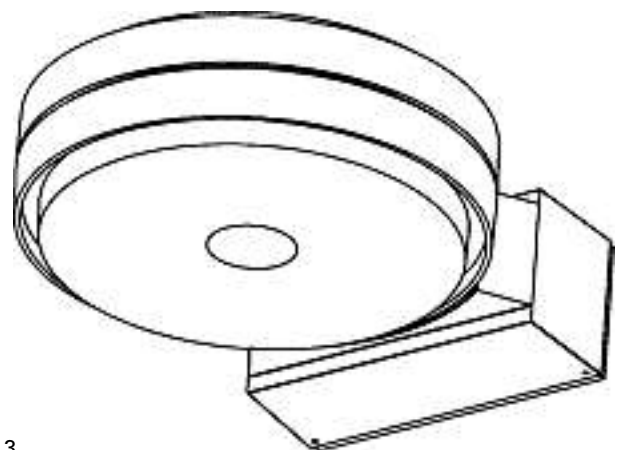
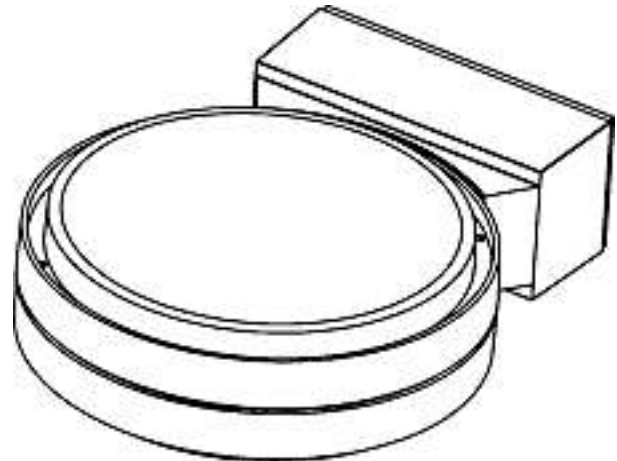
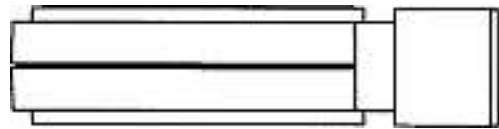
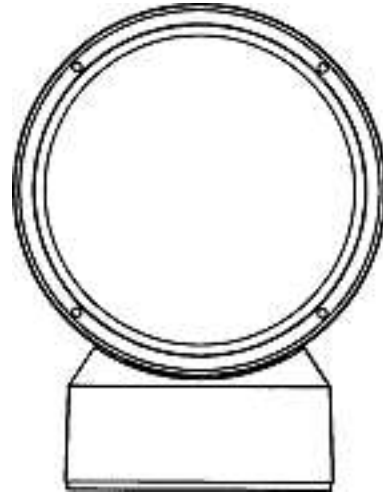
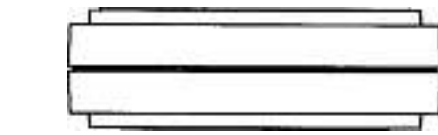
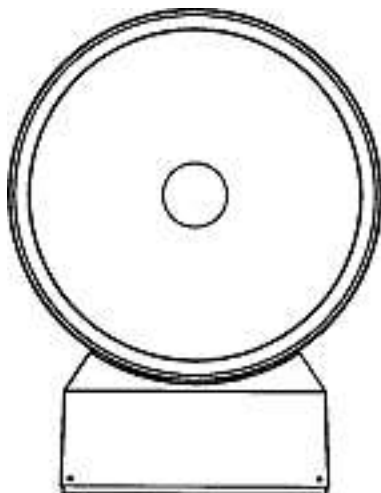

3



4

Cl. 26-05 **132 582** 27.01.2006
 2 Design – Beleuchtungskörper
 Hinterleger: Huco AG Leuchtenfabrik, Weinfelderstrasse 82,
 9542 Münchwilen TG
 Designer: Adrian Erismann, Münchwilen



Evolux 1



Evolux 2

Cl. 26-05 **132 583** 27.01.2006
 1 Design – Beleuchtungskörper
 Hinterleger: Huco AG Leuchtenfabrik, Weinfelderstrasse 82,
 9542 Münchwilen TG
 Designer: Eva Lüdi, Zürich; Samuel Gäumann, Zürich;
 Martin von der Ropp, Zürich; Thomas Thüring, Zürich



Indilux-R

Cl. 26-05 132 585 02.02.2006
 1 Design – Lampe
 Hinterleger: Christian Michael Looser, Luisenstrasse 32,
 8005 Zürich

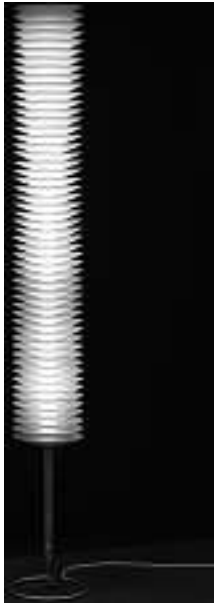

Ambient light

Cl. 26-05 132 586 09.02.2006
 2 design – lampe
 Déposant: Steve Léchet, rue de Beausite 28, 2740 Moutier



Edison's wife



Organza 36

Cl. 26-05 132 587 13.02.2006
 2 Design – Leuchten
 Hinterleger: Rolf Benz AG & Co. KG,
 Haierbacher Strasse 104, 72202 Nagold, DE
 Designer: Joachim Nees, Schöllkrippen
 Vertreter: Bovard AG, 3000 Bern 25
 Priorität: EM, 05.10.2005; EM, 05.10.2005



1



2

**Verlängerungen
Prolongations
Prolongazioni**

118 600 Cl. 26-01 2 Design

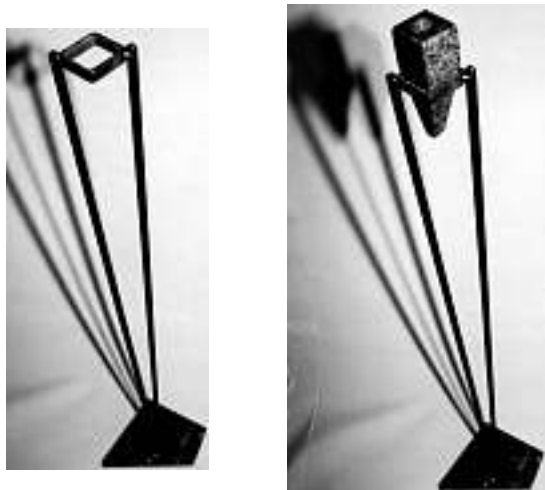

1

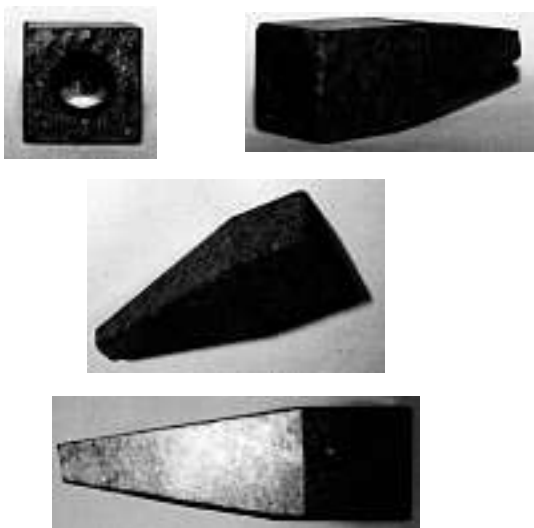

2

122 537	Cl.	19-04	1 design
122 881	Cl.	09-03	3 design
122 882	Cl.	09-03	2 design
123 166	Cl.	07-02	1 design
123 319	Cl.	24-04	1 Design
123 328	Cl.	06-01	1 Design
123 422	Cl.	06-04	2 design
127 167	Cl.	21-02	1 Design
127 742	Cl.	06-04	1 Design
127 750	Cl.	09-09	1 Design
127 754	Cl.	11-02	1 Design
127 764	Cl.	23-02	1 Design
127 810	Cl.	21-01	1 Design
127 812	Cl.	25-02	3 Design
127 816	Cl.	28-03	1 Design
127 827	Cl.	06-01	1 design
127 859	Cl.	24-04	1 Design
127 879	Cl.	07-06	1 design
127 910	Cl.	09-03	3 Design
127 947	Cl.	08-07	1 Design
127 951	Cl.	13-02	1 Design

**Mutationen
Modifications
Modificazioni**
118 741

Namensänderung/
Namensänderung/
Übertragung/
Übertragung/
Namensänderung
Hinterleger: Roller Force, Inc., One Sportsystem Plaza,
Bordentown, NJ, US
Hinterleger: Benetton Sportsystem USA, Inc.,
One Sportsystem Plaza, Bordentown, NJ 08505, US
Hinterleger: Rollerblade USA, Corp., 19 Technology Drive,
West Lebanon, NH, US
Hinterleger: Rollerblade S.r.l., Via Montebelluna, 5/7,
31040 Trevignano (TV), IT
Hinterleger: Nordica S.p.A., Via Montebelluna, 5/7,
Trevignano (Treviso), IT
Vertreter: Patentanwaltsbureau Jean Hunziker AG,
8126 Zumikon

118 982

Vertreter Firmaänderung
Vertreter: Unilever Schweiz Service AG, 6330 Cham 2

127 167

Neuer Vertreter
Vertreter: R. A. Egli & Co., Patentanwälte, 8008 Zürich

127 947

Neuer Vertreter
Vertreter: Isler & Pedrazzini AG, 8023 Zürich

132 358

Übertragung
Hinterleger: ültje GmbH, Binnerheide 28, Schwerte, DE
Vertreter: E. Blum & Co., 8044 Zürich

**Löschungen
Radiations
Radiazioni**

118 374	Cl.	23-02	10	Design
118 377	Cl.	02-02	2	Design
118 380	Cl.	03-01	2	design
118 396	Cl.	11-02	2	Design
118 500	Cl.	25-01	18	design
122 558	Cl.	09-03	1	Design
122 570	Cl.	15-05	1	Design
122 586	Cl.	30-03	1	Design
122 668	Cl.	23-02	1	Design
122 761	Cl.	23-04	1	design
127 212	Cl.	06-05	2	Design
127 213	Cl.	06-09	3	Design
127 231	Cl.	20-02	2	Design
127 244	Cl.	06-01	1	Design
127 245	Cl.	06-01	1	Design
127 247	Cl.	06-03	2	Design
127 259	Cl.	11-02	1	Design
127 260	Cl.	11-02	1	Design
127 261	Cl.	11-02	1	Design
127 264	Cl.	14-03	1	Design
127 271	Cl.	25-01	1	Design
127 272	Cl.	27-03	1	Design
127 274	Cl.	30-01	2	Design
127 280	Cl.	06-05	1	Design
127 299	Cl.	19-04	3	Design
127 301	Cl.	19-08	5	Design
127 368	Cl.	08-03	1	design
127 400	Cl.	24-02	3	Design