

Nationale Hinterlegungen

In der folgenden Liste werden die beim Eidgenössischen Institut für Geistiges Eigentum hinterlegten Designs publiziert. Dabei sind der Reihe nach angegeben:

- internationale Klassenangaben
- Hinterlegungsnummer
- Hinterlegungsdatum
- Allenfalls Aufschub der Veröffentlichung
- Anzahl der hinterlegten Designs
- Bezeichnung
- Name und Wohnsitz des Hinterlegers oder der Hinterlegerin
- gegebenenfalls Name und Wohnsitz des Designers oder der Designerin
- Name und Geschäftssitz des allfälligen Vertreters oder der Vertreterin
- gegebenenfalls Prioritätsangaben
- gegebenenfalls Beschreibungstext
- Ordnungsnummer
- Reproduktion des Designs

Internationale Hinterlegungen

Die bei der Weltorganisation für geistiges Eigentum in Genf hinterlegten Muster und Modelle mit Benennung Schweiz geniessen den gleichen Schutz wie national hinterlegte Designs. Sie werden jeweils im Blatt «Bulletin des dessins et modèles internationaux» veröffentlicht. Dieses Publikationsorgan ist deshalb für eine vollständige Recherche unbedingt beizuziehen.

Topographien

Angaben über die vom Eidgenössischen Institut für Geistiges Eigentum eingetragenen Topographien von Halbleitererzeugnissen werden in folgender Anordnung aufgeführt:

- Eintragsnummer
- Anmeldedatum
- Bezeichnung
- Name und Wohnsitz des Anmelders oder der Anmelderin
- gegebenenfalls Name und Wohnsitz des Herstellers oder der Herstellerin
- Name und Geschäftssitz des oder der allfälligen Bevollmächtigten
- Datum und Ort einer allfälligen ersten geschäftlichen Verbreitung der Topographie

Dépôts nationaux

Les designs déposés à l'Institut Fédéral de la Propriété Intellectuelle sont publiés dans la liste qui suit. Les indications y relatives sont mentionnées dans cet ordre:

- indications des classes internationales
- numéro de dépôt
- date de dépôt
- le cas échéant, ajournement de la publication
- nombre des designs déposés
- désignation
- nom et domicile du/de la déposant/e
- le cas échéant, nom et domicile du/de la designer
- nom et domicile de l'éventuel/le mandataire
- le cas échéant, indication de priorité
- le cas échéant, description du design
- numéro attribué à chaque design
- reproduction du design

Dépôts internationaux

Les dessins et modèles déposés à l'Organisation Mondiale de la Propriété Intellectuelle à Genève qui désignent la Suisse jouissent de la même protection que les dépôts nationaux. Ils sont chaque fois publiés dans la feuille «Bulletin des dessins et modèles internationaux». Pour une recherche complète, il est indispensable de consulter ledit organe de publication.

Topographies

Les indications concernant les topographies des produits semi-conducteurs, enregistrées par l'Institut Fédéral de la Propriété Intellectuelle, sont énumérées dans l'ordre suivant:

- numéro d'enregistrement
- date de dépôt
- désignation
- nom et domicile du/de la déposant/e
- le cas échéant, nom et domicile du/de la producteur/trice
- nom et domicile de l'éventuel/le mandataire
- date et lieu d'une éventuelle première mise en circulation de la topographie

Depositi nazionali

Nella lista seguente vengono pubblicati i design depositati presso l'Istituto Federale della Proprietà Intellettuale. Sono menzionati nel seguente ordine:

- indicazioni delle classi internazionali
- numero di deposito
- data del deposito
- se del caso, indicazione che la pubblicazione è stata differita
- numero dei design depositati
- designazione
- nome e domicilio del depositante
- se del caso, nome e domicilio del designer
- nome e sede di un eventuale mandatarario
- se del caso, indicazioni di priorità
- se del caso, descrizione del design
- numero d'ordine
- riproduzione del design

Depositi internazionali

I disegni e modelli depositati presso l'Organizzazione Mondiale della Proprietà Intellettuale a Ginevra con denominazione Svizzera godono della medesima protezione del deposito nazionale. Essi vengono pubblicati ogni volta nel foglio «Bulletin des dessins et modèles internationaux». Quest'organo di pubblicazione è da consultare se si vuole effettuare una ricerca completa.

Topografie

Le indicazioni concernenti le topografie di prodotti a semiconduttori depositati presso l'Istituto Federale della Proprietà Intellettuale sono menzionate nell'ordine seguente:

- numero di registrazione
- data del deposito
- designazione
- nome e domicilio del/la richiedente
- se del caso, nome e domicilio del/la produttore/trice
- nome e sede di un eventuale mandatarario
- data e luogo di un'eventuale prima messa in circolazione della topografia

**Hinterlegungen
Dépôts
Deposit**

Cl. 19-08 129 161 11.11.2002
 1 Design – Faltprospekt
 Hinterleger: Ergocom AG, Bergackerstrasse 23, 6330 Cham
 Designer: Claudius Borer, Cham
 Vertreter: Fuhrer Marbach & Partner, 3007 Bern
 Ende aufgeschobene Publikation

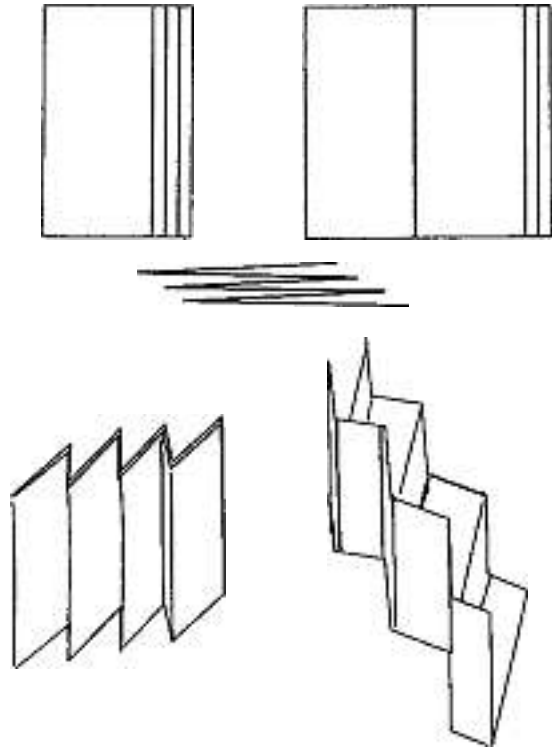

373-CH-16-MOD01/650569

Cl. 02-07 131 443 30.12.2004
 1 Design – Gürtel
 Hinterleger: Carola Schaffner, Einsiedlerstrasse 160,
 8810 Horgen



3

Cl. 02-07 131 444 24.01.2005
 1 Design – Schuhriemen
 Hinterleger: Nadja Tinner-Benz, Läui 20, 9466 Sennwald



1

Cl. 03-01 131 445 11.01.2005
 1 Design – Tragtasche
 Hinterleger: Zürcher Stiftung für Gefangenen- und
 Entlassenenfürsorge, Geschäftsstelle, Militärstrasse 76,
 8004 Zürich
 Designer: Cornelia Pitschi, Zürich
 Beschreibung des Designs: Papiertragtasche aus
 schweizerischem und ausländischen Kartenmaterial
 (Landkarten, Strassenkarten, Stadtpläne) und
 entsprechenden Kartenmakulaturbogen.





050111 mapbag

Cl. 03-01 **131 447** 17.01.2005
 1 Design – Kabelbox
 Hinterleger: Fachhochschule Aargau Nordwestschweiz,
 Departement Gestaltung und Kunst, Bahnhofstrasse 102,
 5000 Aarau
 Designer: Thomas Giger, Wettswil



Cablebox_05_1

Cl. 03-03 **131 448** 07.01.2005
 1 Design – Schirmgriff
 Hinterleger: Doppler Schirme, H. Würflingsdobler & Co KG,
 A.-Kolping-Strasse 3, Simbach / Inn, DE
 Designer: Margit Würflingsdobler, Braunau
 Vertreter: Patentanwaltsbüro, Dr. Urs Falk, 6312 Steinhausen
 Priorität: DE, 31.07.2004



D3CH

Cl. 04-01 **131 449** 10.01.2005
 45 Design – Schrubberformen
 Hinterleger: Trisa Holding AG, Kantonsstrasse, 6234 Triengen
 Designer: Daniel Lutz, Nesslau
 Vertreter: Patentanwälte, Schaad, Balass, Menzl & Partner AG,
 8034 Zürich



1A



1B



1C

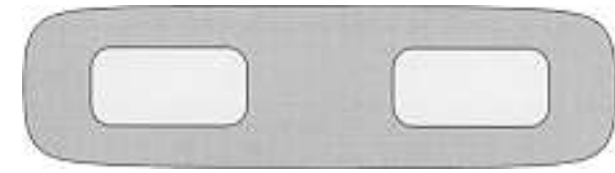

1D

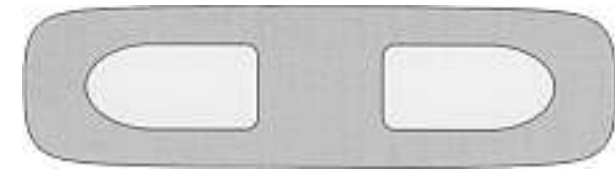

1E



1F



1G



1H



1I

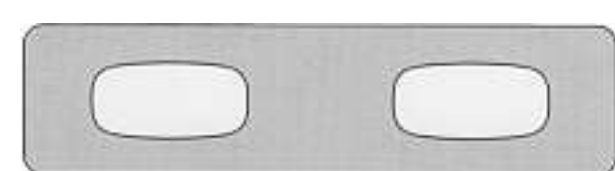

2A



2B

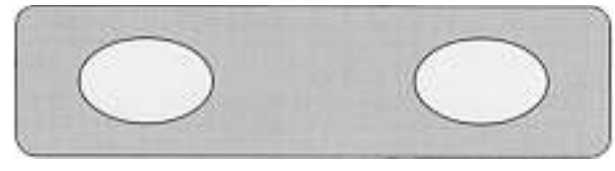

2C



2D

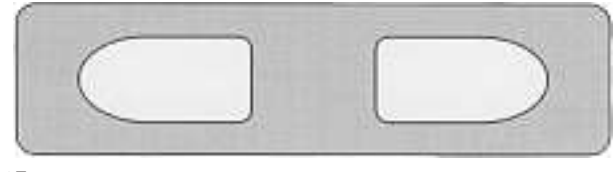

2E

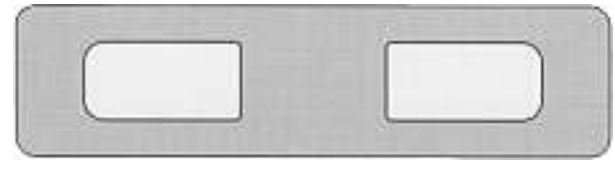

2F



2G



2H



2I

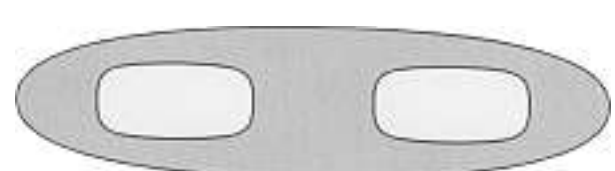

3A



3B



3C



3D



3E



3F



3G



3H



3I

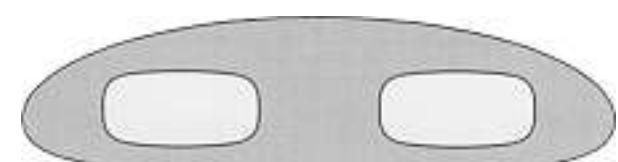

4A



4B



4C



4D

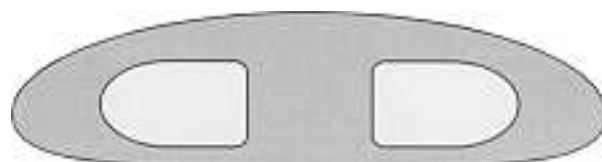

4E



4F



4G



4H



4I

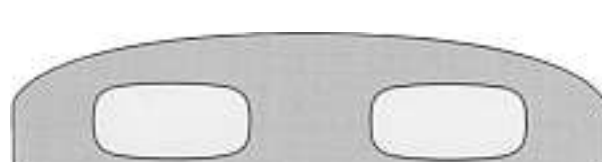

5A



5B



5C



5D

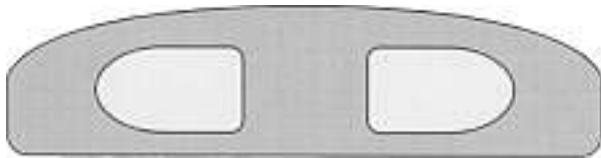

5E



5F

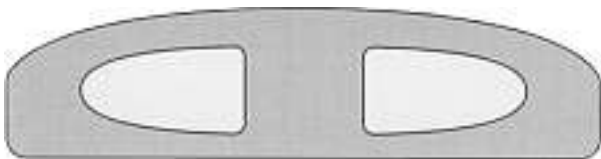

5G



5H



5I



Cl. 04-02 **131 450** 20.12.2004
 1 Design – Zahnbürste mit Aufsatz
 Hinterleger: GlaxoSmithKline Consumer Healthcare,
 GmbH & Co. KG, Bussmatten 1, Bühl, DE
 Designer: Tamas Berde, Bühl
 Vertreter: Isler & Pedrazzini AG, 8023 Zürich
 Priorität: GB, 22.06.2004

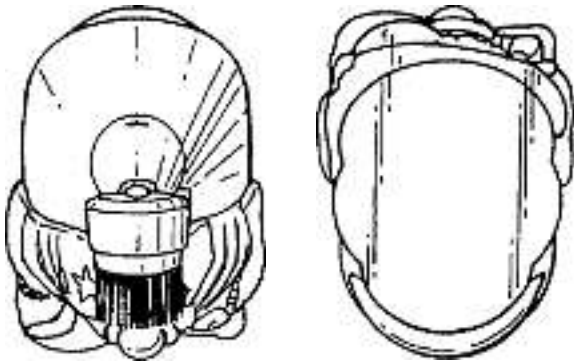

M12968

Cl. 04-02 **131 451** 20.12.2004
 1 Design – Zahnbürste mit Aufsatz
 Hinterleger: GlaxoSmithKline Consumer Healthcare,
 GmbH & Co. KG, Bussmatten 1, Bühl, DE
 Designer: Tamas Berde, Bühl
 Vertreter: Isler & Pedrazzini AG, 8023 Zürich
 Priorität: GB, 22.06.2004

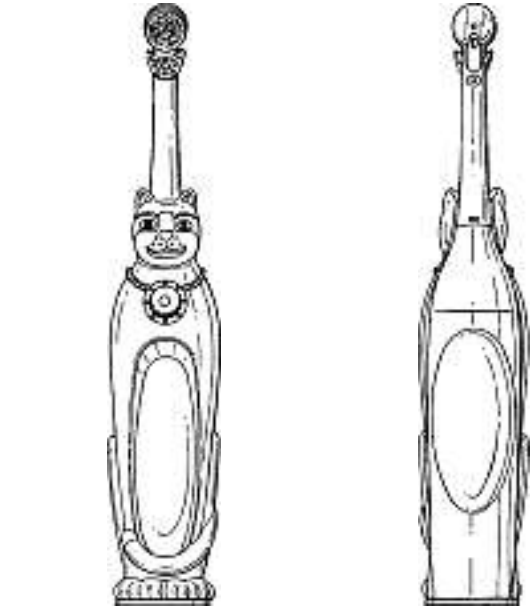
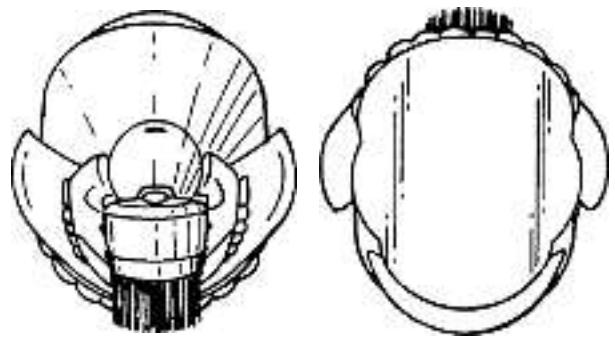
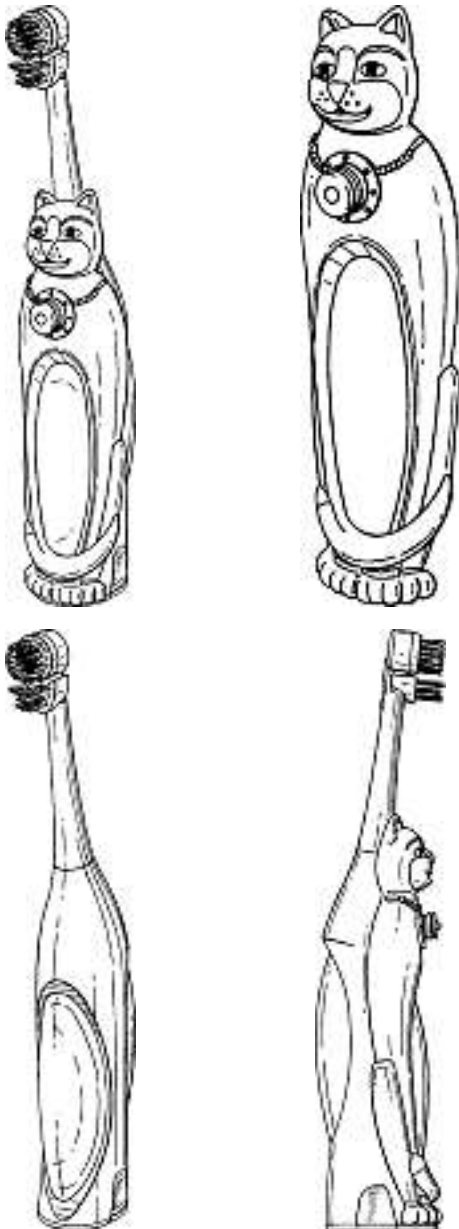

M12969

Cl. 06-01, 06-03, 06-06 **131 452** 14.12.2004
 20 Design – Tische, Tischelemente, Stühle
 Hinterleger: Tisch & Stuhl Willisau AG, Menznauerstrasse 21,
 6130 Willisau
 Designer: Lino Amati, Willisau



01



02



03



04



05



06



07



08



09



10



13



11



14



12



15



16



19



17



20



18

Cl. 06-01 131 453 15.01.2005
1 Design – Stuhl
Hinterleger: Anatom GmbH, Rodtmattstrasse 94, 3014 Bern
Designer: Kurt Schneider, Steffisburg; Hanspeter Wittwer,
Hinterkappelen; Leonides Wittwer, Hinterkappelen;
Charles Bichsel, Hinterkappelen

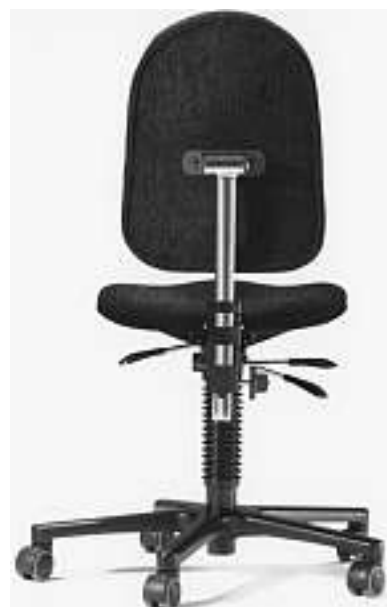

Silya Junior

Cl. 06-01 **131 454** 21.01.2005
 2 Design – Stühle und Liegestühle
 Hinterleger: Gebr. Stern GmbH & Co. KG,
 Maybachstrasse 13, Affalterbach, DE
 Designer: Ewald Winkelbauer, Ludwigsburg
 Vertreter: Zimmerli, Wagner & Partner AG, 8001 Zürich
 Priorität: EM, 22.12.2004



1





2

Cl. 06-02, 06-06 131 455 07.01.2005
 4 Design – Bettzubehörteile, Leuchtbett
 Hinterleger: Adrian Bitterlin, Kreuzmattweg 4, 4450 Sissach



RFR1



RFR2

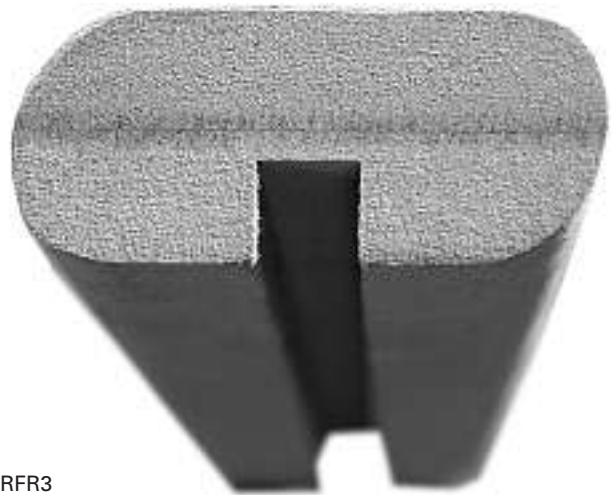

RFR3



RFR4

Cl. 06-04, 06-99 131 456 11.01.2005
 3 Design – Weihnachtsbaumständer, Teil von
 Weihnachtsbaumständer, Schirmständer
 Hinterleger: Ott Metalldruckerei AG, Steinacker 15,
 9556 Affeltrangen
 Designer: Jakob Ott, Märwil



Nr. 12050



Nr. 12190



Nr. 12070

Cl. 06-04 131 457 14.01.2005
 2 Design – Gestell
 Hinterleger: Sergio Stupan, Rabbentalterpe 2, 3013 Bern

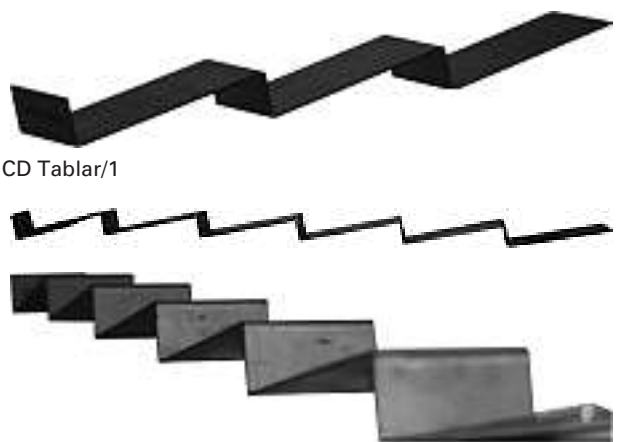

CD Tablar/1

CD Tablar/2

Cl. 07-06 131 458 04.01.2005
 1 Design – Untersetzer
 Hinterleger: MOHA Moderne Haushaltswaren AG,
 Tannholzstrasse 14, 3052 Zollikofen
 Designer: Ulrich Greiner, Langenau
 Vertreter: Schneider Feldmann AG, 8039 Zürich



1

Cl. 08-02 **131 459** 21.01.2005
 1 Design – Meisselhammer
 Hinterleger: Airtec AG, Industriestrasse 40, 4455 Zunzgen
 Designer: Hans-Rudolf Hauenstein, Zunzgen
 Vertreter: Industrieberatung Maier AG, 4450 Sissach



1

Cl. 08-08 **131 460** 07.01.2005
 1 Design – Badetuch und Decken-Halterung
 Hinterleger: Walter Steiner, Talgasse 3, 5503 Schafisheim



W.St.19111945.

Cl. 09-01 **131 461** 11.01.2005
 1 design – bouteille
 Déposant: Société Autonome de Verreries, Place de la Gare, Feuquières, FR
 Designer: Didier Rica, Le Mont Saint Adrien
 Mandataire: Inteltech SA, 2001 Neuchâtel
 Priorité: EM, 13.08.2004
 Description du design: L'originalité de ce modèle réside dans:

- la section rectangulaire du corps de la bouteille,
 - la silhouette élancée et conique,
 - les faces planes et les angles aigus aux 4 extrémités,
 - un épaulement presque horizontal,
 - un long col cylindrique pouvant accepter plusieurs types de bagues,
 - des épaisseurs de verre importantes, notamment sous la forme d'une haute semelle de verre à la base.
- Ce modèle peut faire l'objet d'une déclinaison en diverses contenances utiles.

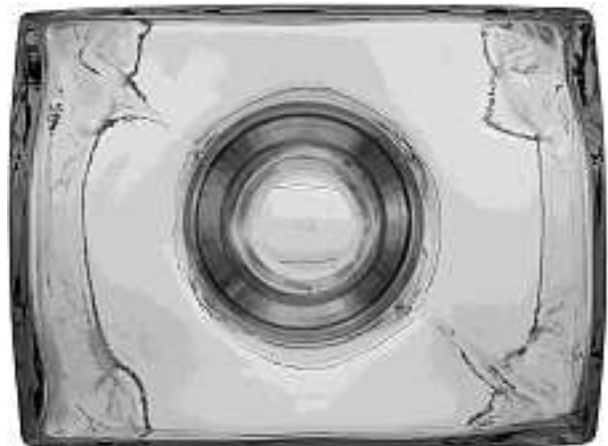



157700/010006

Cl. 09-03 **131 462** 30.12.2004
 1 Design – Nahrungsmittelbehälter
 Hinterleger: Mars, Incorporated, A Delaware Corporation,
 6885 Elm Street, McLean/VA, US
 Designer: Kai Kolterman, Hamburg; Ute Simon, Hamburg
 Vertreter: A.W. Metz & Co. AG, 8024 Zürich
 Priorität: EM, 05.07.2004





50896-CH-09-DE



Cablebox_05_2

Cl. 09-09 **131 464** 04.01.2005

1 Design – Abfalleimer

Hinterleger: Fabian Zimmerli, Dorfstrasse 5, 8532 Warth

Cl. 09-03 **131 463** 17.01.2005

1 Design – Verkaufsverpackung

Hinterleger: Fachhochschule Aargau Nordwestschweiz,
 Departement Gestaltung und Kunst, Bahnhofstrasse 102,
 5000 Aarau

Designer: Thomas Giger, Wettswil





1

Cl. 10-02 131 465 06.12.2004
 1 design – montre-bijou sur bracelet
 Déposant: Rama Watch SA, chemin de Prapion 12,
 2520 La Neuveville
 Designer: Alexandre Widmer, Lausanne



RSW/0412

Cl. 10-02 131 466 07.01.2005
 5 design – montres
 Déposant: Ira Krieger, 1665 Washington Avenue, Miami
 Beach (FL 33139), US
 Mandataire: Mathieu North, Docteur en droit, Avocat,
 2001 Neuchâtel



1



3



2



4





5

Cl. 10-07 **131 467** 06.12.2004
 1 design – montre bracelet
 Déposant: Rama Watch SA, chemin de Prapion 12,
 2520 La Neuveville
 Designer: Alexandre Widmer, Lausanne



RSW/0411

Cl. 10-07 **131 468** 09.01.2005
 1 Design – Uhrenzifferblatt mit Zeiger
 Hinterleger: Rico Perl, Hagenholzstrasse 57, 8302 Kloten;
 Anneliese Perl, Hagenholzstrasse 57, 8302 Kloten; Andri Perl,
 Zipfelstrasse 28, 8302 Kloten; Madlaina Perl,
 Hofackerstrasse 65, 8032 Zürich; Kathrin Perl,
 Kasernenstrasse 50, 8180 Bülach
 Designer: Rico Perl, Kloten
 Vertreter: Andri Perl, 8302 Kloten

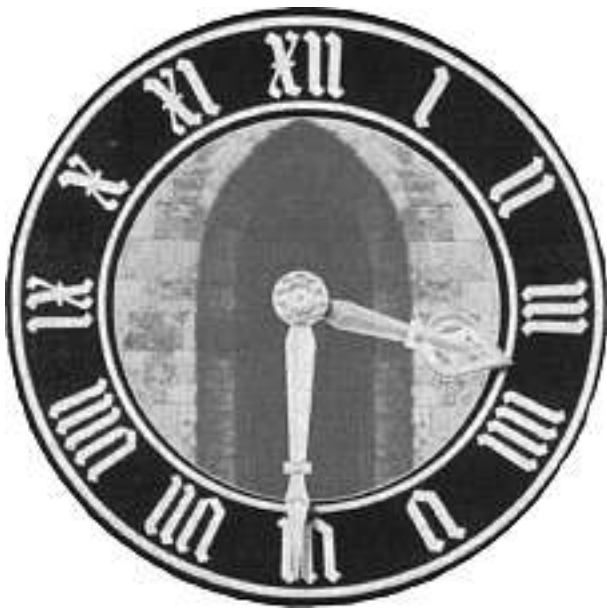

Zürich1

Cl. 11-01 131 470 31.01.2005
 1 Design – Ring
 Hinterleger: Corinne Jeisy, Röschiachstrasse 54,
 8037 Zürich; Martina Christoffel, Hornbachstrasse 65,
 8008 Zürich
 Vertreter: Corinne Jeisy, 8037 Zürich

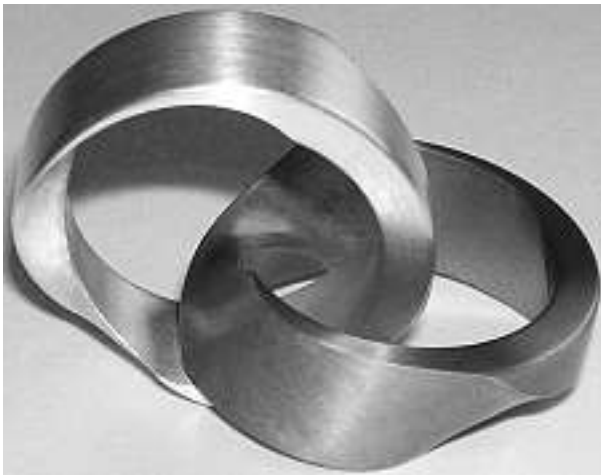

Döbius 1

Cl. 11-02 131 471 04.01.2005
 2 Design – Wand-Skulptur
 Hinterleger: Urs Heinzmann, Furrumattstrasse,
 3932 Visperterminen

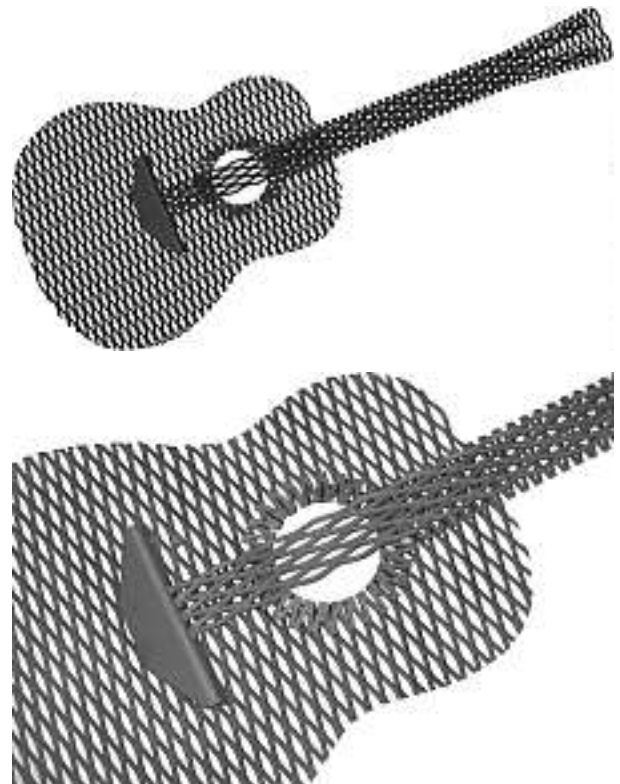

1

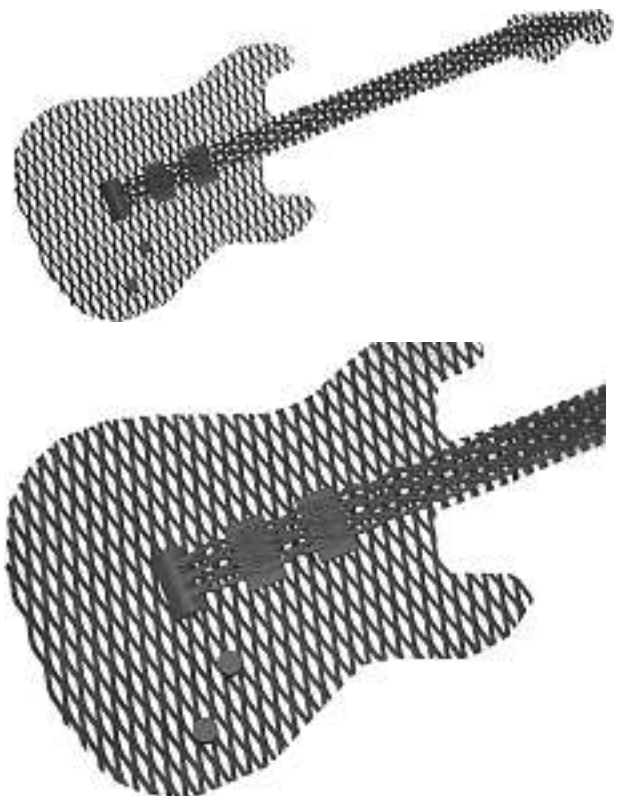

2

Cl. 11-02 131 472 14.01.2005
 7 Design – Figuren
 Hinterleger: Dieter Breitzkreutz, August-Bebel-Strasse 8,
 Rostock, DE
 Vertreter: E. Blum & Co., 8044 Zürich
 Priorität: EM, 29.09.2004



A-2005/1006a

A-2005/1006b



A-2005/1006f



A-2005/1006c



A-2005/1006g



A-2005/1006d

A-2005/1006e

Cl. 12-08 **131 473** 12.01.2005
 2 Design – Automobil-Karosserie
 Hinterleger: Horst Peter Maskus, Hegebergweg 7,
 Wolfsburg, DE
 Vertreter: Lenka Mikova, 6039 Root Längenbold
 Priorität: DE, 27.12.2004

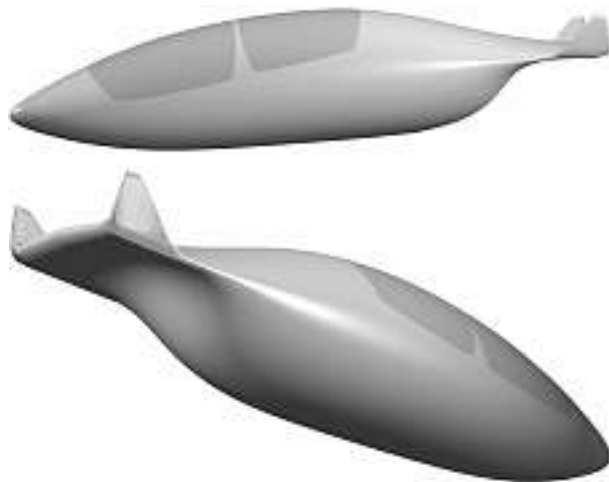



Acabion Winglet



Acabion Straight

Cl. 12-08 131 474 28.01.2005
1 Design – Fahrzeug
Hinterleger: Perusahaan Otomobil Nasional Sdn. Bhd.,
HICOM Industrial Estate, 40000 Shah Alam, Selangor Darul
Ehsan, MY
Designer: Anthony John Bushell, Bartley Green;
Barney Joe Hatt, Norwich
Vertreter: A.W. Metz & Co. AG, 8024 Zürich
Priorität: GB, 30.07.2004





52698-CH-12-DA

Cl. 15-05 131 475 05.01.2005
 1 Design – Staubsauger
 Hinterleger: BSH Bosch und Siemens Hausgeräte GmbH,
 Carl-Wery-Strasse 34, München, DE
 Designer: Jörg Schröter, Gröbenzell
 Vertreter: Isler & Pedrazzini AG, 8023 Zürich
 Priorität: EM, 08.07.2004





M12979

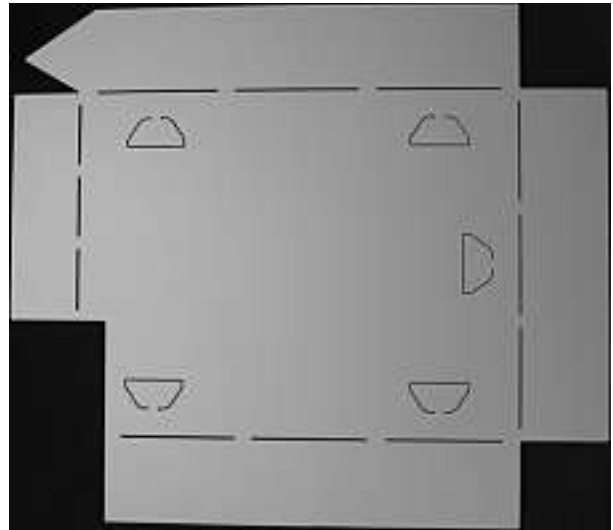

3

Cl. 19-02 131 476 21.01.2005
 5 Design – Faltbüroboxen
 Hinterleger: Alban Schär, Schalerstrasse 11, 4054 Basel

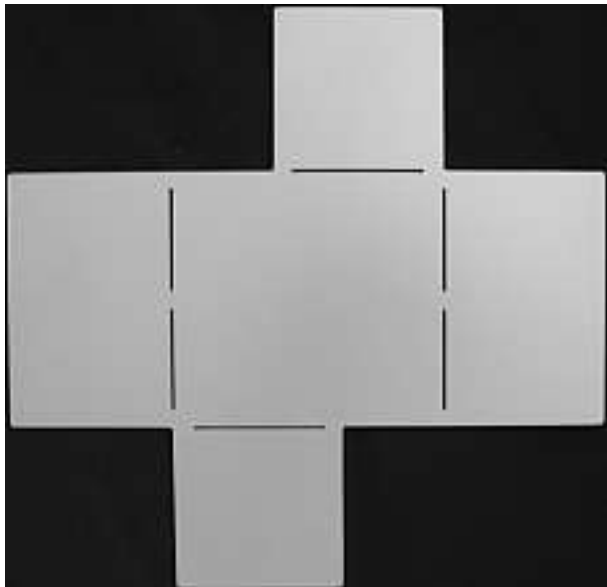

1

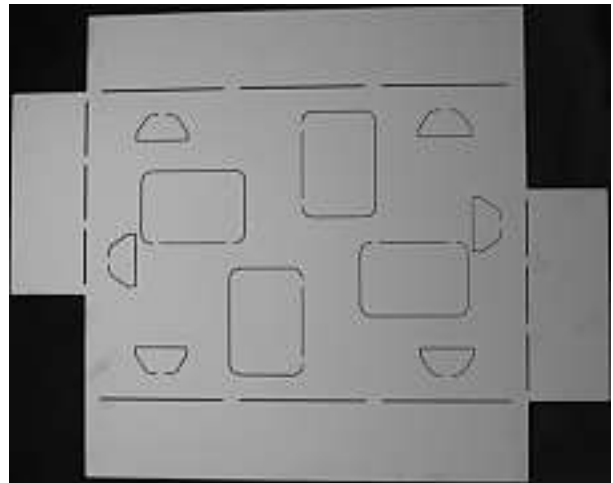

4

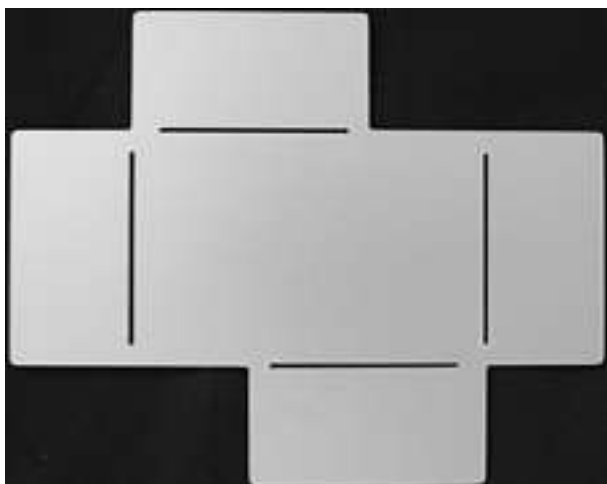

2

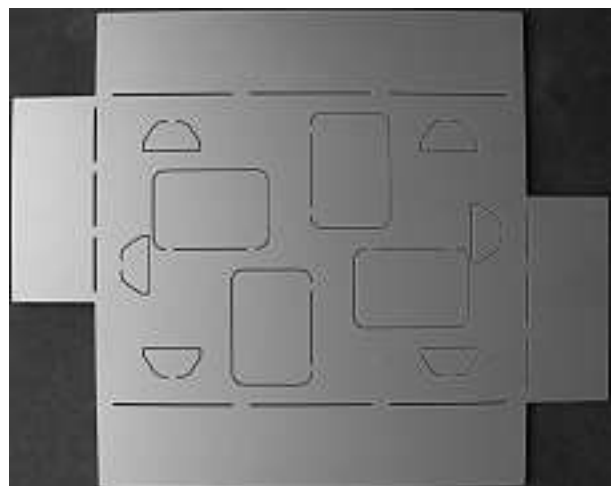

5

Cl. 19-99 131 477 06.01.2005
 1 Design – Kartenhalter
 Hinterleger: Maschinenfabrik Rieter AG, Klosterstrasse 20,
 8406 Winterthur
 Designer: Fabrizio Di Maggio, Winterthur



DM/PS/3069

Cl. 20-02 **131 478** 17.02.2005
 3 design – présentoirs
 Déposant: DELTA DESIGN COMMUNICATION SA, 152 C,
 route de Thonon, 1245 Collonge-Bellerive
 Designer: Yves Adolphe, Genève
 Mandataire: Brandt & Buholzer, Avocats, 1204 Genève

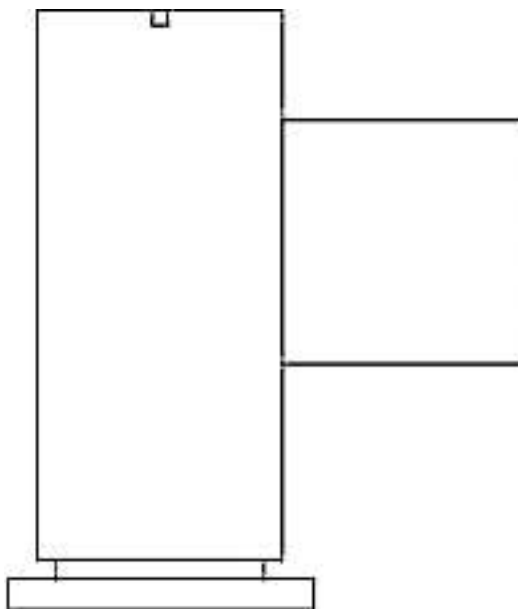
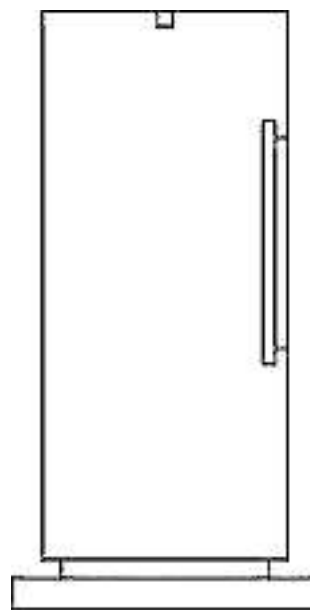
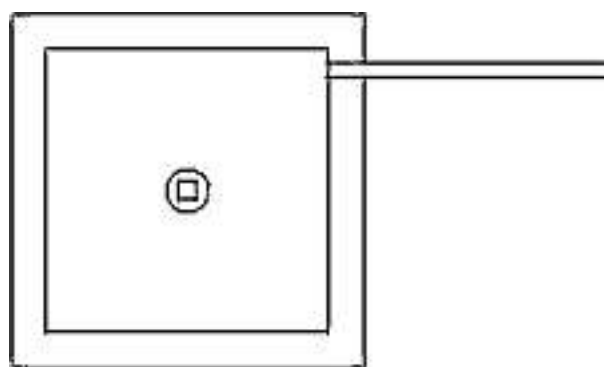
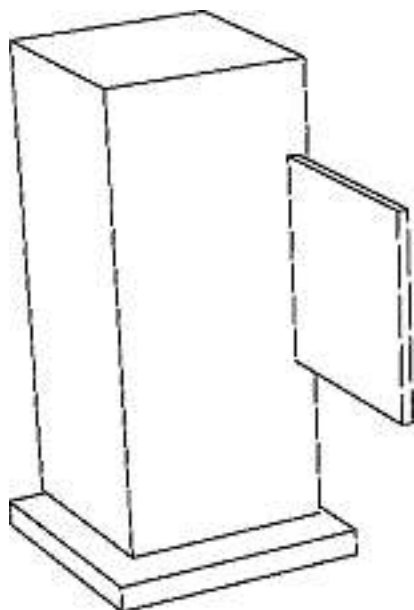
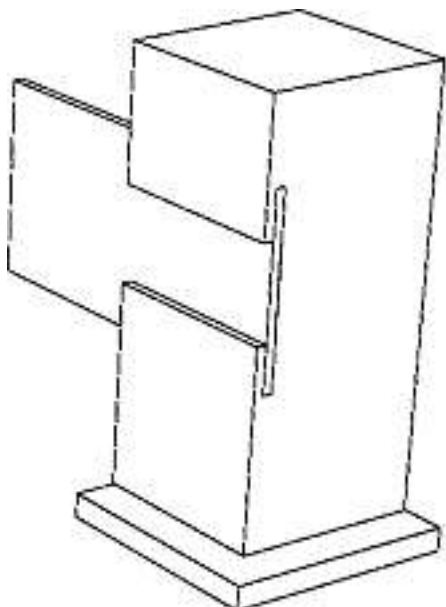

6

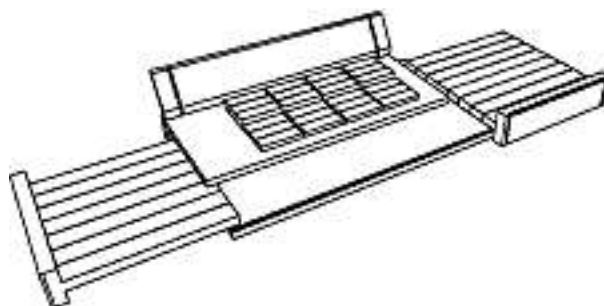

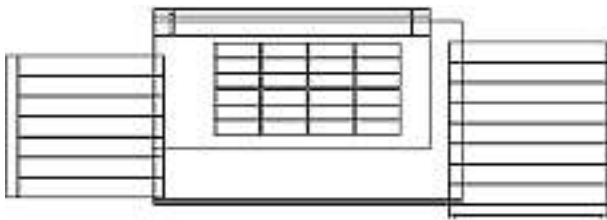

7

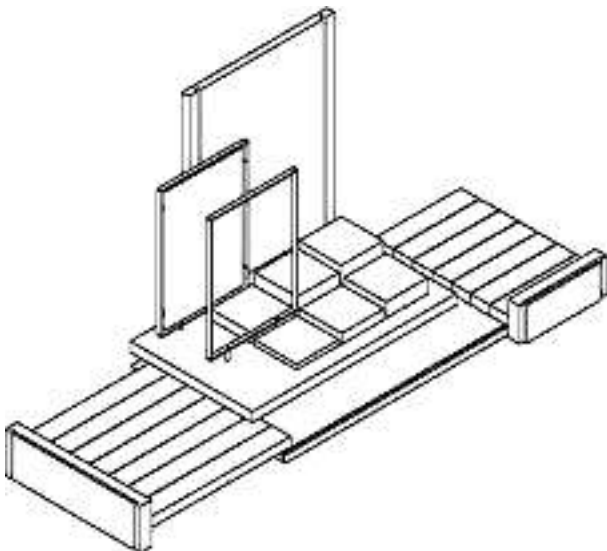
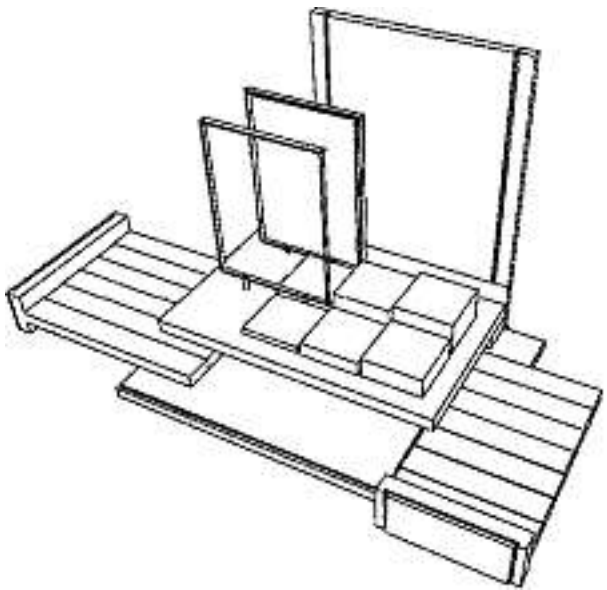
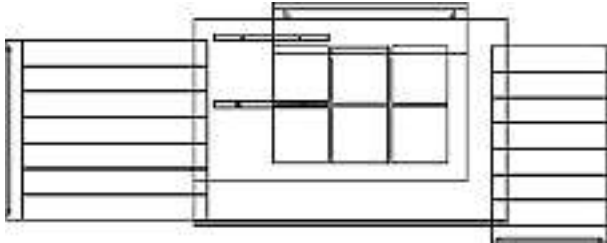

8

Cl. 20-03 131 479 14.01.2005
 1 Design – Werbeträger
 Hinterleger: SYMBOLMANAGEMENT WIDMER AG, BILD-
 HAUER & DESIGN, Unterdorfstrasse 7, 9125 Brunnadern
 Designer: Franz Widmer, Brunnadern



Werbetürme Widmer

Cl. 21-01 131 480 05.01.2005
 5 Design – Bemusterung für Spielbrett und Spielfiguren
 Hinterleger: Stoll, Traber & Partner AG, Museumstrasse 10,
 3006 Bern
 Designer: Rena Witschi, Bern

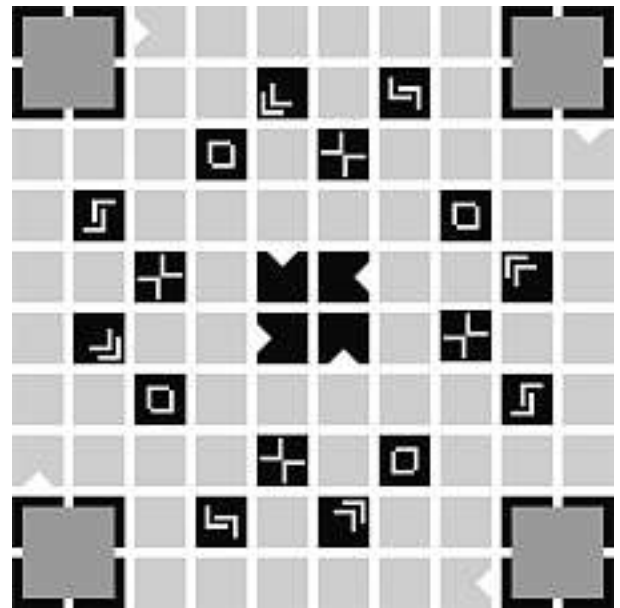

ume Egge 1



ume Egge 2



ume Egge 3



ume Egge 4



ume Egge 5

Cl. 21-01 131 481 22.01.2005
1 Design – Spielbaustein
Hinterleger: Gottfried E. Derendinger, Altikofenstrasse 26,
3048 Worblaufen



05.01 9 squares

Cl. 21-03 131 482 05.01.2005
7 design – automate pour jeux, panneaux pour automates de jeux
Déposant: GamesMatic SA, Route de Tavel 4, 1707 Fribourg
Designer: Karim Perroulaz, Fribourg
Mandataire: Bovard AG, 3000 Bern 25



1

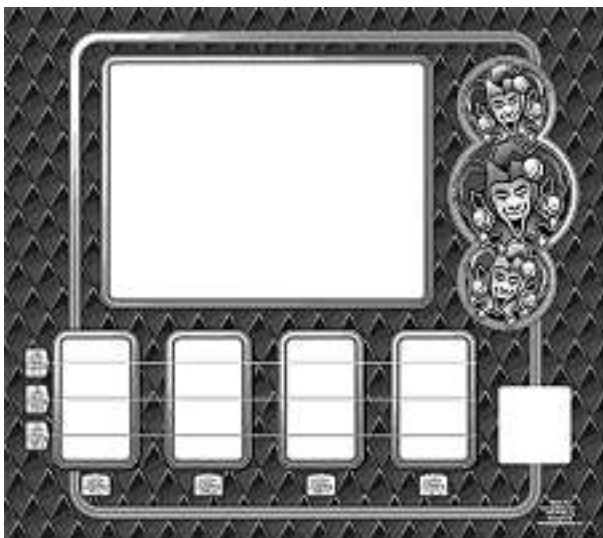

2



3



4



5



6



7



D 4278/1



D 4278/2

Cl. 23-01 131 483 28.01.2005
 2 Design – Profilrohre
 Hinterleger: Andreas Lupold Hydrotechnik GmbH,
 Gartenstrasse 32, Vöhringen, DE
 Designer: Wilhelm Lupold, Vöhringen
 Vertreter: R. A. Egli & Co., Patentanwälte, 8008 Zürich
 Priorität: EM, 02.08.2004



Cl. 23-02 131 484 29.12.2004
 37 Design – WC-Sitze, WC-Deckel
 Hinterleger: Neoperl Servisys AG, Pfeffingerstrasse 21,
 4153 Reinach BL
 Designer: Daniella de Grood, Mol Belgie; Roger Weisskopf,
 Wädenswil; Beat Wismer, Basel; Wolfgang Bär, Wunsiedel;
 Marion Schulte, Straelen; Ulrike Beckmann, Straelen
 Vertreter: A. Braun, Braun, Héritier, Eschmann AG,
 Patentanwälte, 4051 Basel



1



3



2



4



5

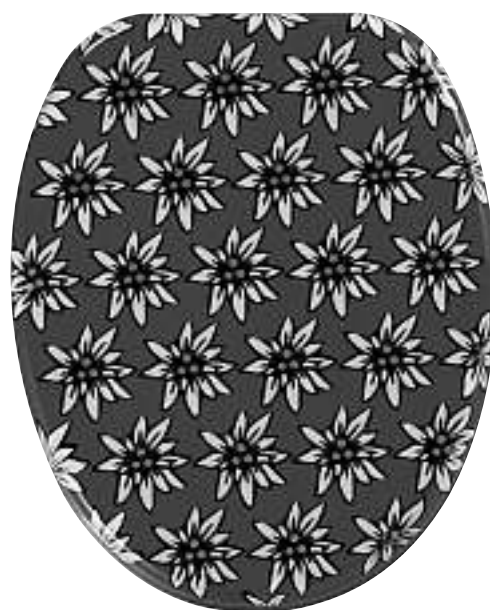



6

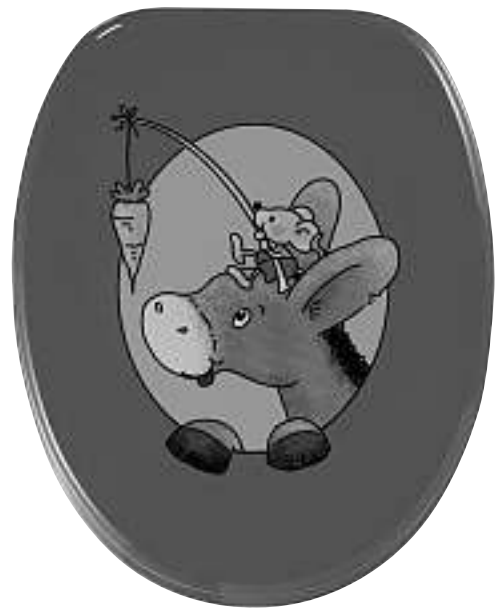

7



9



8



10

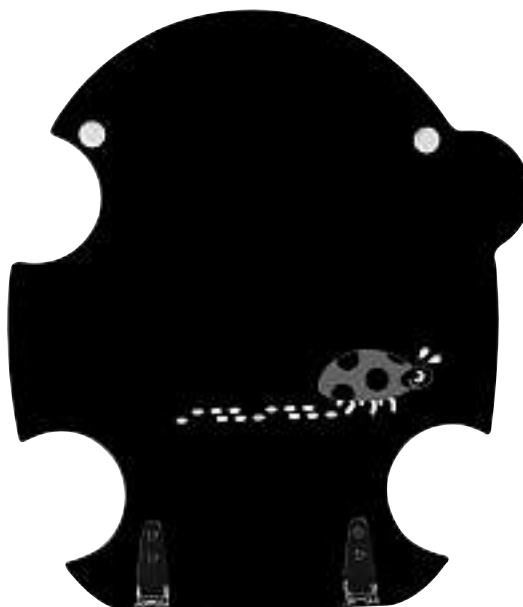

11

13



12

14



15



18



16



19



17



20



21



24



22



25



23



26



27



30



28



31



29



32



33



36



34



37



35

Cl. 23-04 131 485 17.01.2005
 1 Design – Ventilator
 Hinterleger: Stadler Form Aktiengesellschaft,
 Widenstrasse 33, 6317 Oberwil b. Zug
 Designer: Carlo Borer, Zuchwil



Cl. 24-02 131 486 27.01.2005
1 Design – Lichttherapiegerät
Hinterleger: Leto Holdings, LLC, 352 West 1060 South, Orem,
UT, US
Designer: Steven D. Powell, Orem; Kent W. Savage,
American Fork; David Meyers, Kaysville
Vertreter: E. Blum & Co., 8044 Zürich
Priorität: US, 30.07.2004

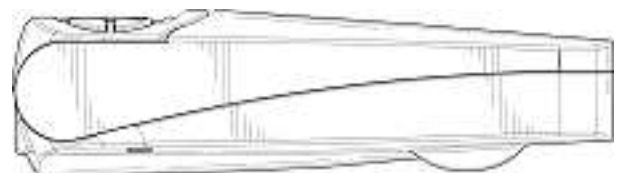
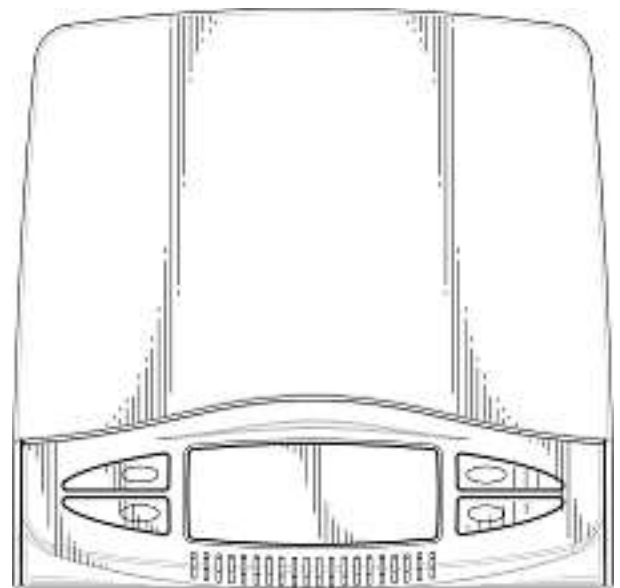

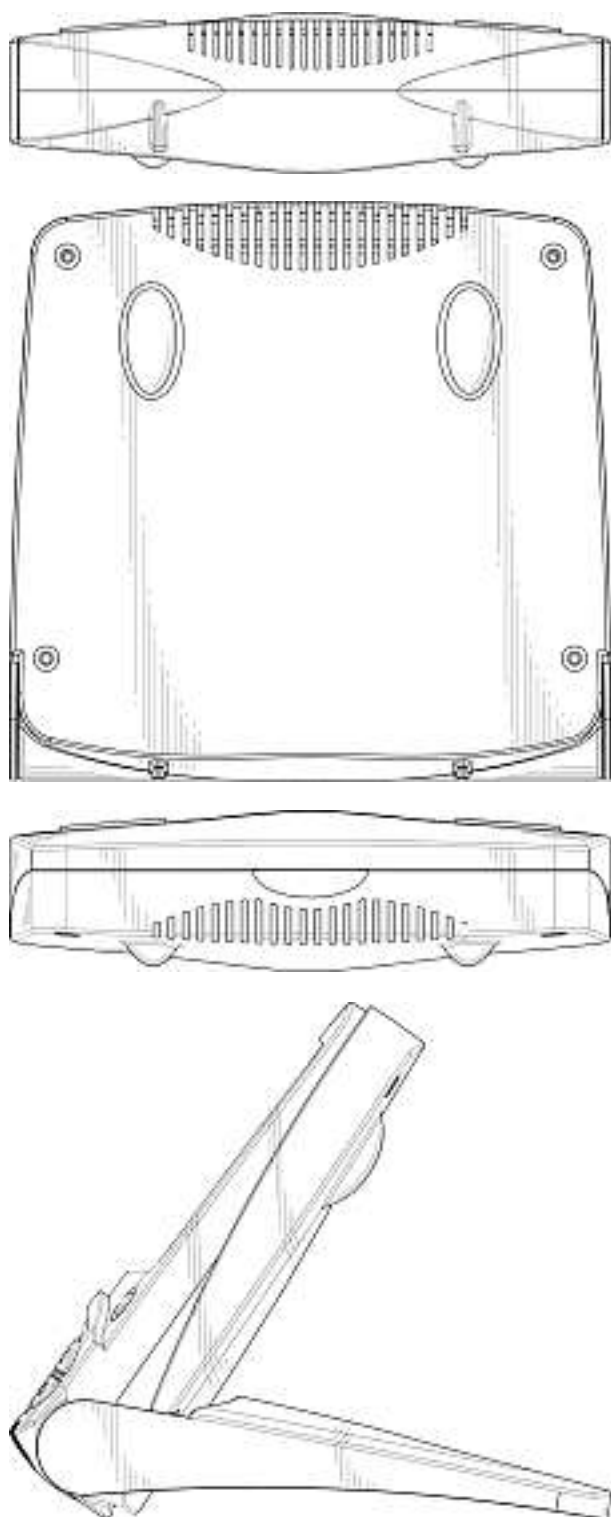

A-2005/1007

Cl. 24-04 **131 487** 22.12.2004
 1 Design – Inhalationsgerät
 Hinterleger: AstraZeneca AB, Global Intellectual Property,
 Södertälje, SE
 Designer: Laurence Huxham, Loughborough; Darren Hodson,
 Loughborough; William Treneman, Cambridge; Nick
 Harrison, Cambridge; Martin Bunce, Marlborough;
 William Davis, Marlborough
 Vertreter: Bovard AG, 3000 Bern 25
 Priorität: SE, 06.07.2004

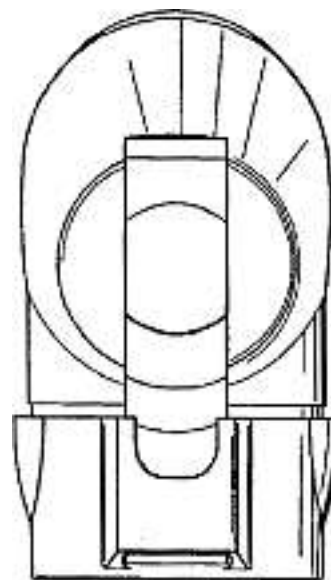
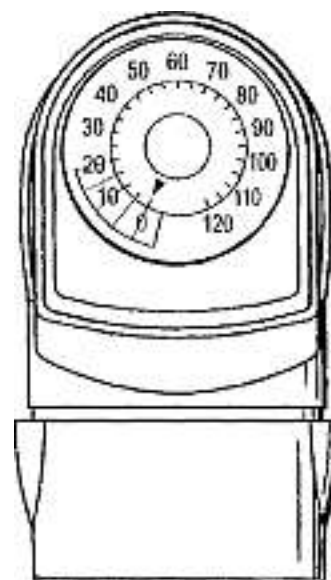
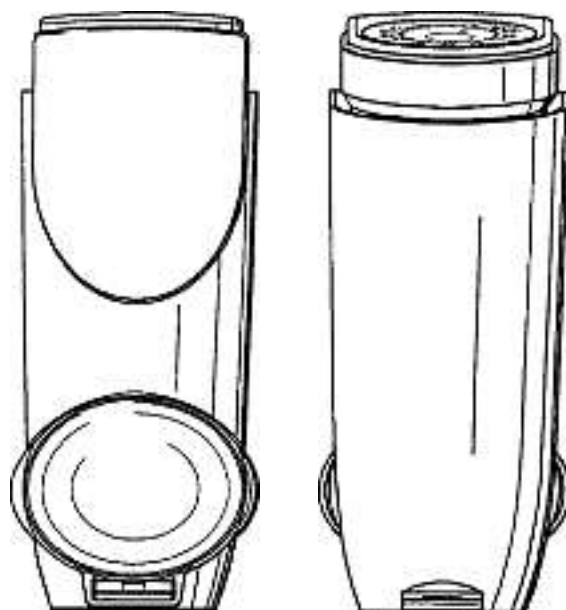

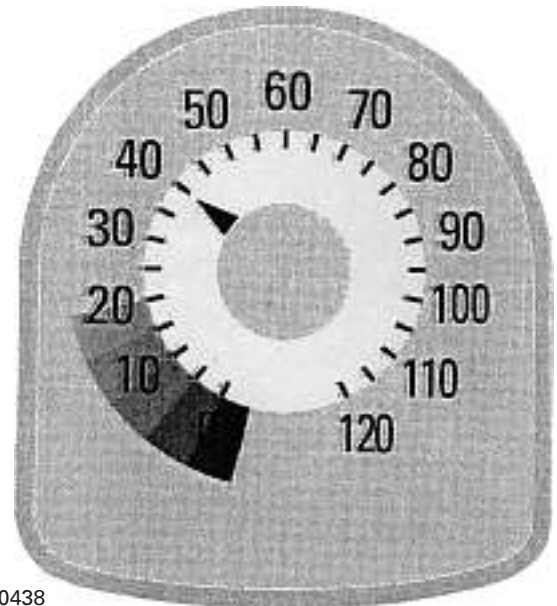
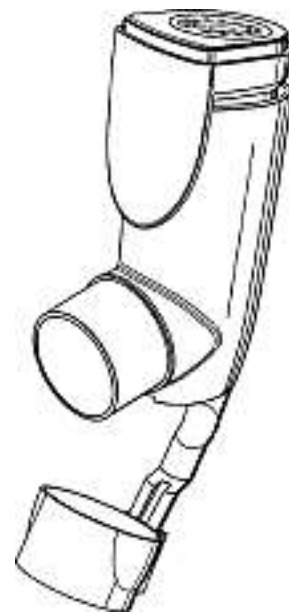
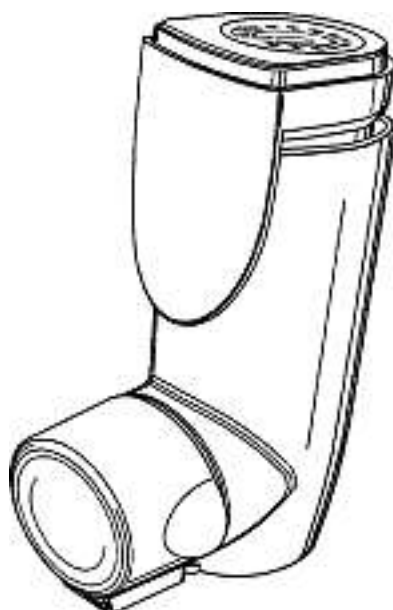
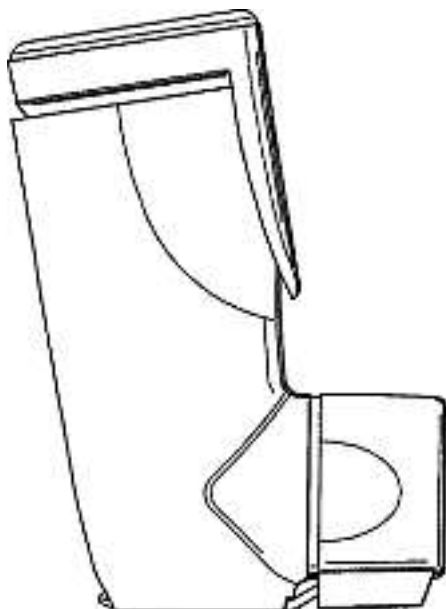
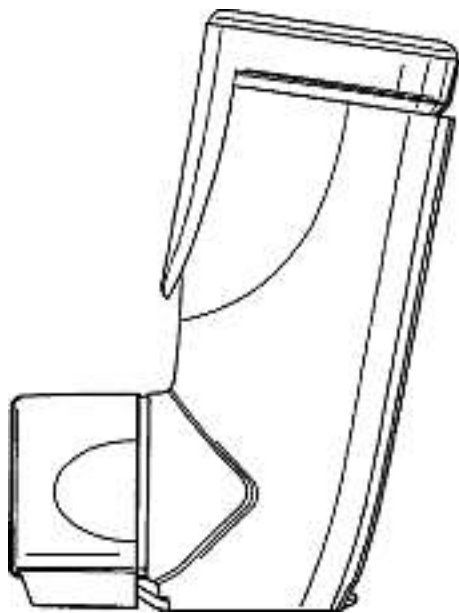

300438

Cl. 25-01 **131 488** 17.01.2005
3 Design – Bauprofile, Verbinder
Hinterleger: Matrix Systems GmbH, Dorfstrasse 57,
8103 Unterengstringen
Designer: Edwin Huber, Andelfingen



Evolution 1



Evolution 2



Flexi

Cl. 25-01 **131 489** 08.03.2005
 1 Design – Profil
 Hinterleger: ESI Profil + Montage, E. Siebold, Landstrasse 19,
 4303 Kaiseraugst
 Designer: Edwin Siebold, Kaiseraugst



32'767a

Cl. 26-02 **131 490** 02.01.2005
 1 Design – LED Lampe
 Hinterleger: Bruno Rupp, Belpstrasse 50, 3123 Belp



3er LED Lampe V1.0

Cl. 26-05 **131 491** 03.01.2005
 2 Design – Stehleuchten
 Hinterleger: Urs Gramelsbacher, Leonhardsgraben 61,
 4051 Basel

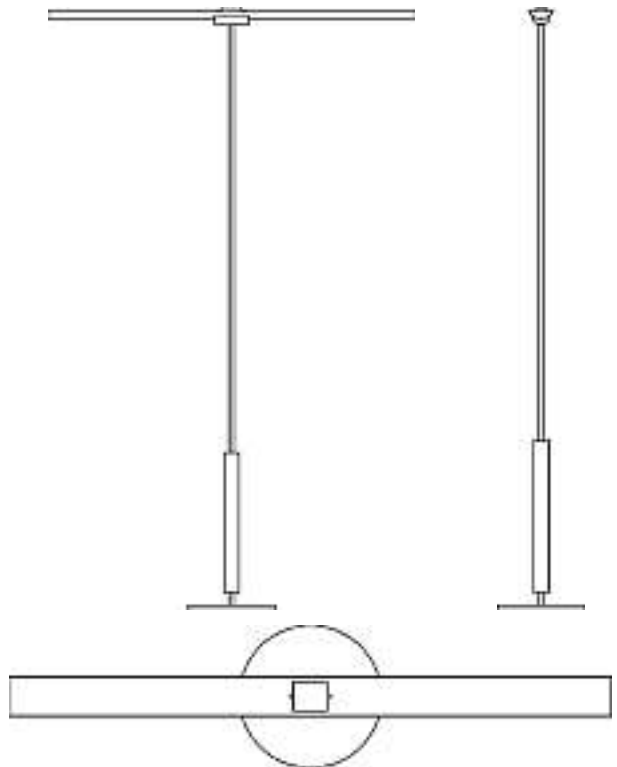

T55

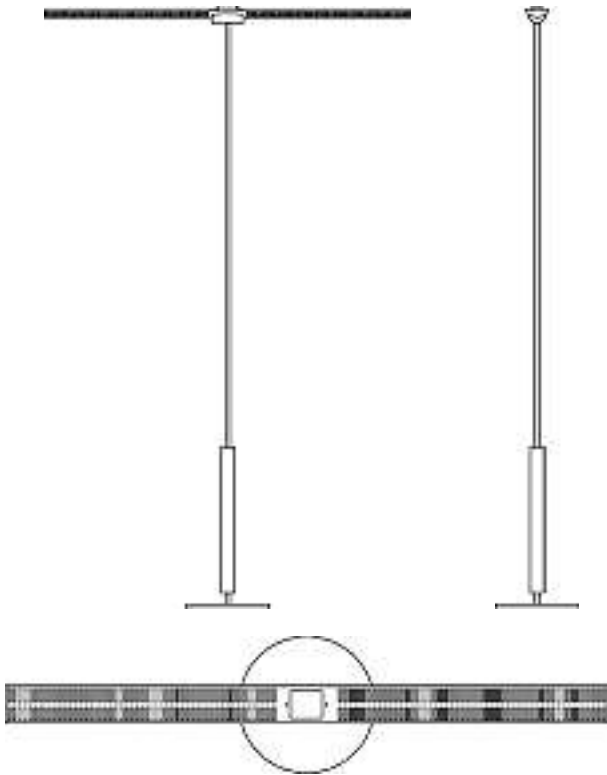

T80

Cl. 26-05 **131 492** 28.01.2005
 2 Design – Deckenleuchten
 Hinterleger: Zumtobel Staff GmbH & Co. KG,
 Grevenmarschstrasse 74-78, 32657 Lemgo, DE
 Designer: Luciano Cesaro, Cesate
 Vertreter: A. Braun, Braun, Héritier, Eschmann AG,
 Patentanwälte, 4051 Basel
 Priorität: EM, 30.07.2004; EM, 30.07.2004

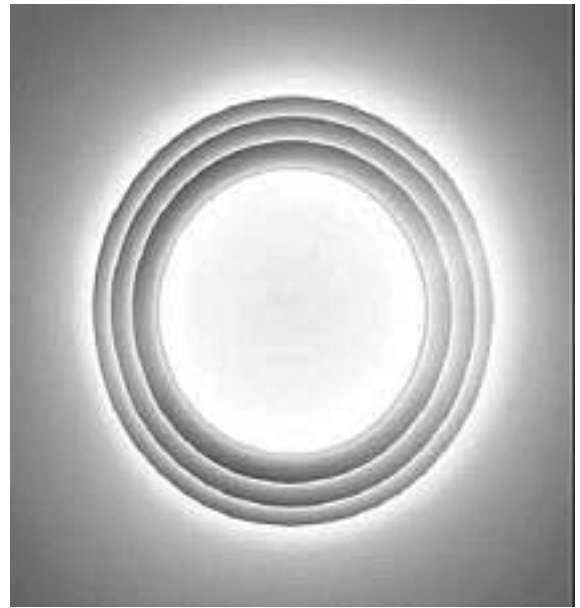

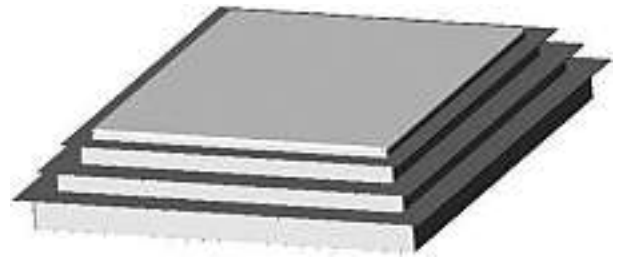

D. 1/2005-2

Cl. 99-00 131 493 20.01.2005
5 Design – Urnen
Hinterleger: Brigitte Bigler, Belchenweg 23, 5033 Buchs AG



D. 1/2005-1



1a

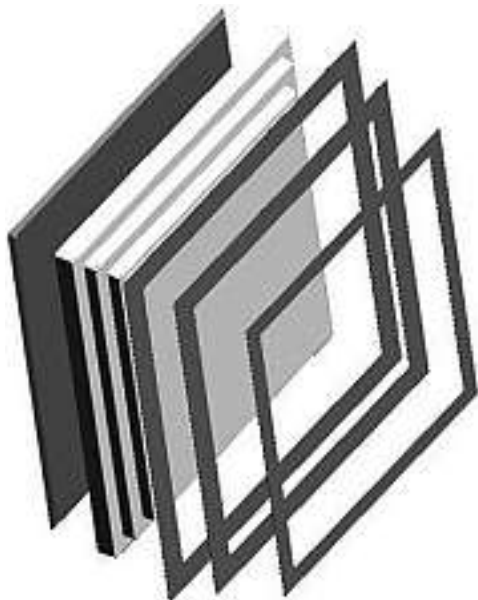

1b



2



3



4

**Verlängerungen
Prolongations
Prolongazioni**

118 090 Cl. 25-01 1 Design



1

118 171 Cl. 09-03 3 Design



1



2



3

118 181 Cl. 15-05 1 Design

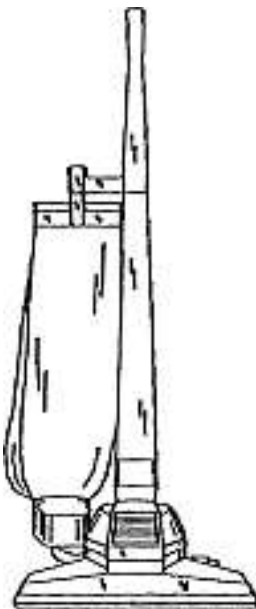
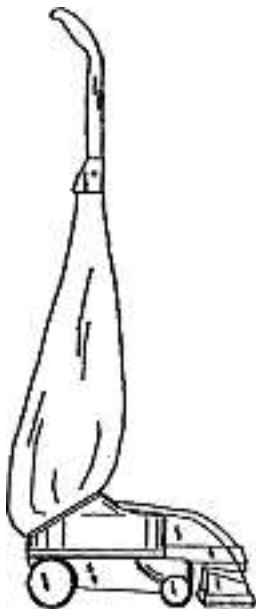
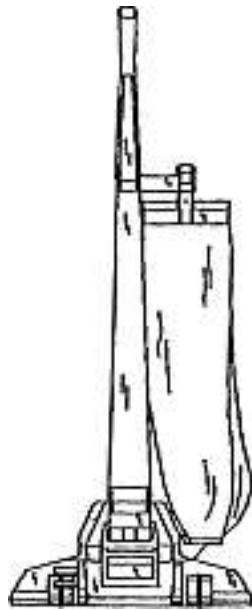
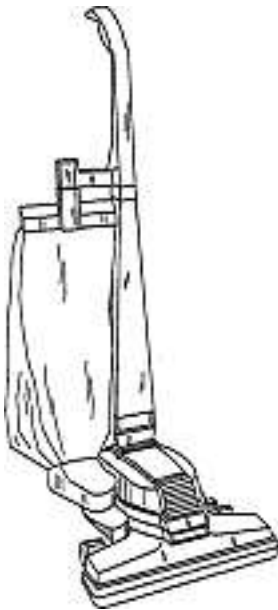

122 115	Cl.	09-01	2	Design
122 215	Cl.	30-08	1	Design
122 229	Cl.	14-99	2	Design
122 230	Cl.	14-99	2	Design
122 246	Cl.	31-00	1	Design
122 406	Cl.	09-01	1	design
122 415	Cl.	21-01	1	design
122 466	Cl.	23-03	10	Design
126 802	Cl.	07-01	1	Design
126 813	Cl.	11-02	6	Design
126 832	Cl.	25-01	1	Design
126 836	Cl.	26-05	22	Design
126 858	Cl.	12-10	1	Design
126 864	Cl.	23-03	1	Design
126 870	Cl.	06-01	2	Design
126 877	Cl.	06-03	9	Design
126 949	Cl.	14-02	1	Design
126 951	Cl.	16-03	1	Design
126 989	Cl.	09-07	1	Design
127 052	Cl.	07-02	3	Design
127 074	Cl.	15-99	2	Design
127 075	Cl.	15-99	1	Design
127 076	Cl.	15-99	13	Design
127 077	Cl.	15-99	1	Design
127 078	Cl.	15-99	1	Design
127 079	Cl.	15-99	1	Design
127 080	Cl.	15-99	1	Design
127 081	Cl.	15-99	1	Design
127 088	Cl.	24-04	1	Design
127 118	Cl.	10-04	1	Design
127 147	Cl.	09-01	1	Design
127 199	Cl.	19-99	1	Design

**Mutationen
Modifications
Modificazioni**
118 479

Namensänderung/Übertragung
Hinterleger: MP Real Estate AG, c/o Deliciel AG,
Bruggerstrasse 48, 5413 Birmenstorf AG
Hinterleger: Mövenpick-Holding, Luzernerstrasse 9,
6330 Cham

127 147

Neuer Vertreter
Vertreter: Staiger, Schwald & Partner, Rechtsanwälte,
3000 Bern 6

130 788

Übertragung
Hinterleger: Bikeboard AG, Kellenäckerweg 5,
5301 Siggenthal Station

131 102

Übertragung
Hinterleger: Techno Bloxx GmbH, Riweyweg 14,
3954 Leukerbad
Vertreter: Ammann Patentanwälte AG Bern, 3001 Bern

**Löschungen
Radiations
Radiazioni**

117 625	Cl.	06-01	1 Design
117 629	Cl.	09-03	1 Design
117 634	Cl.	10-02	1 Design
117 711	Cl.	09-01	2 Design
121 593	Cl.	19-08	1 Design
121 594	Cl.	02-03	2 Design
121 607	Cl.	08-07	1 Design
121 636	Cl.	06-04	1 design
121 643	Cl.	09-01	1 Design
121 652	Cl.	13-02	1 Design
121 653	Cl.	13-02	1 Design
121 706	Cl.	06-01	2 Design
121 741	Cl.	25-01	1 Design
126 302	Cl.	06-01	2 Design
126 326	Cl.	25-01	12 Design
126 330	Cl.	02-04	1 Design
126 331	Cl.	02-07	1 Design
126 332	Cl.	04-02	1 Design
126 333	Cl.	04-02	1 Design
126 335	Cl.	06-07	4 Design
126 336	Cl.	06-07	4 Design
126 342	Cl.	07-02	1 design
126 347	Cl.	09-03	1 design
126 348	Cl.	10-02	1 design
126 356	Cl.	13-01	3 design
126 357	Cl.	13-03	3 Design
126 362	Cl.	14-02	2 Design
126 363	Cl.	14-02	1 Design
126 371	Cl.	20-02	1 design
126 373	Cl.	21-03	1 Design
126 375	Cl.	25-01	3 Design
126 378	Cl.	26-05	1 Design
126 379	Cl.	26-05	2 Design
126 396	Cl.	19-08	18 Design
126 429	Cl.	16-06	1 Design
126 432	Cl.	21-01	1 Design