

## Nationale Hinterlegungen

In der folgenden Liste werden die beim Eidgenössischen Institut für Geistiges Eigentum hinterlegten Designs publiziert. Dabei sind der Reihe nach angegeben:

- internationale Klassenangaben
- Hinterlegungsnummer
- Hinterlegungsdatum
- Allenfalls Aufschub der Veröffentlichung
- Anzahl der hinterlegten Designs
- Bezeichnung
- Name und Wohnsitz des Hinterlegers oder der Hinterlegerin
- gegebenenfalls Name und Wohnsitz des Designers oder der Designerin
- Name und Geschäftssitz des allfälligen Vertreters oder der Vertreterin
- gegebenenfalls Prioritätsangaben
- gegebenenfalls Beschreibungstext
- Ordnungsnummer
- Reproduktion des Designs

## Internationale Hinterlegungen

Die bei der Weltorganisation für geistiges Eigentum in Genf hinterlegten Muster und Modelle mit Benennung Schweiz geniessen den gleichen Schutz wie national hinterlegte Designs. Sie werden jeweils im Blatt «Bulletin des dessins et modèles internationaux» veröffentlicht. Dieses Publikationsorgan ist deshalb für eine vollständige Recherche unbedingt beizuziehen.

## Topographien

Angaben über die vom Eidgenössischen Institut für Geistiges Eigentum eingetragenen Topographien von Halbleitererzeugnissen werden in folgender Anordnung aufgeführt:

- Eintragsnummer
- Anmeldedatum
- Bezeichnung
- Name und Wohnsitz des Anmelders oder der Anmelderin
- gegebenenfalls Name und Wohnsitz des Herstellers oder der Herstellerin
- Name und Geschäftssitz des oder der allfälligen Bevollmächtigten
- Datum und Ort einer allfälligen ersten geschäftlichen Verbreitung der Topographie

## Dépôts nationaux

Les designs déposés à l'Institut Fédéral de la Propriété Intellectuelle sont publiés dans la liste qui suit. Les indications y relatives sont mentionnées dans cet ordre:

- indications des classes internationales
- numéro de dépôt
- date de dépôt
- le cas échéant, ajournement de la publication
- nombre des designs déposés
- désignation
- nom et domicile du/de la déposant/e
- le cas échéant, nom et domicile du/de la designer
- nom et domicile de l'éventuel/le mandataire
- le cas échéant, indication de priorité
- le cas échéant, description du design
- numéro attribué à chaque design
- reproduction du design

## Dépôts internationaux

Les dessins et modèles déposés à l'Organisation Mondiale de la Propriété Intellectuelle à Genève qui désignent la Suisse jouissent de la même protection que les dépôts nationaux. Ils sont chaque fois publiés dans la feuille «Bulletin des dessins et modèles internationaux». Pour une recherche complète, il est indispensable de consulter ledit organe de publication.

## Topographies

Les indications concernant les topographies des produits semi-conducteurs, enregistrées par l'Institut Fédéral de la Propriété Intellectuelle, sont énumérées dans l'ordre suivant:

- numéro d'enregistrement
- date de dépôt
- désignation
- nom et domicile du/de la déposant/e
- le cas échéant, nom et domicile du/de la producteur/trice
- nom et domicile de l'éventuel/le mandataire
- date et lieu d'une éventuelle première mise en circulation de la topographie

## Depositi nazionali

Nella lista seguente vengono pubblicati i design depositati presso l'Istituto Federale della Proprietà Intellettuale. Sono menzionati nel seguente ordine:

- indicazioni delle classi internazionali
- numero di deposito
- data del deposito
- se del caso, indicazione che la pubblicazione è stata differita
- numero dei design depositati
- designazione
- nome e domicilio del depositante
- se del caso, nome e domicilio del designer
- nome e sede di un eventuale mandatarario
- se del caso, indicazioni di priorità
- se del caso, descrizione del design
- numero d'ordine
- riproduzione del design

## Depositi internazionali

I disegni e modelli depositati presso l'Organizzazione Mondiale della Proprietà Intellettuale a Ginevra con denominazione Svizzera godono della medesima protezione del deposito nazionale. Essi vengono pubblicati ogni volta nel foglio «Bulletin des dessins et modèles internationaux». Quest'organo di pubblicazione è da consultare se si vuole effettuare una ricerca completa.

## Topografie

Le indicazioni concernenti le topografie di prodotti a semiconduttori depositati presso l'Istituto Federale della Proprietà Intellettuale sono menzionate nell'ordine seguente:

- numero di registrazione
- data del deposito
- designazione
- nome e domicilio del/la richiedente
- se del caso, nome e domicilio del/la produttore/trice
- nome e sede di un eventuale mandatarario
- data e luogo di un'eventuale prima messa in circolazione della topografia

## Hinterlegungen Dépôts Deposit

Cl. 08-05 129 316 18.12.2002  
3 design – brucelles / pinces  
Déposant: Swittools SA, c/o David A. Sgobero, rue Théodore  
Dumont 1B, 2924 Montignez  
Designer: Nicole Sgobero, Montignez  
Fin de la période ajournement de la publication



01



02



04

Cl. 10-07 129 424 03.03.2003  
3 design – affichage de réserve de marche  
Déposant: Richemont International S.A., Route des Biches 10,  
1752 Villars-sur-Glâne  
Designer: Janek Deleskiewicz, Joinville-le-Pont; Stéphane  
Belmont, St-Sulpice  
Mandataire: Micheli & Cie, 1226 Thônex (Genève)  
Description du design: Affichage de la réserve de marche  
d'un mouvement d'horlogerie. Cet affichage comporte un  
guichet pratiqué dans le fond de la boîte de montre et un  
disque déplaçable angulairement pas à pas. Ce disque porte  
sur sa périphérie des chiffres apparaissant successivement  
dans le guichet. Ces chiffres indiquent en jours ou en heures  
la durée de réserve de marche restante. Cet affichage de la  
réserve de marche est donc digital et sautant.  
Fin de la période ajournement de la publication



PM/ph/13911-SUISSE/1



MPM/ph/13911-SUISSE/2

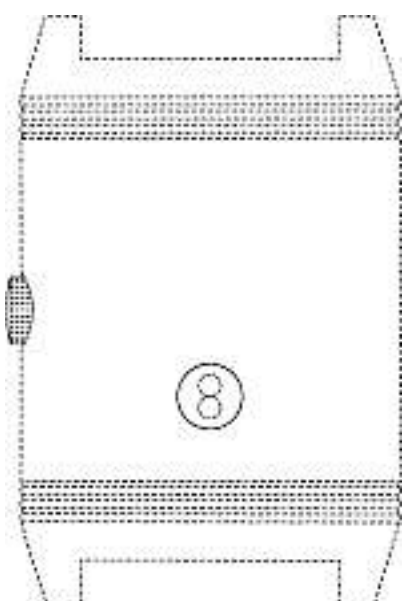

MPM/ph/13911-SUISSE/3

Cl. 09-05 **129 923** 26.09.2003  
 2 design – emballage pour cathéter  
 Déposant: Astra Tech Aktiebolag, Box 14, Mölndal, SE  
 Designer: Daniel Nestenborg, Brännö  
 Mandataire: Bugnion S.A., 1211 Genève 12 - Champel  
 Priorité: SE, 29.04.2003  
 Fin de la période ajournement de la publication



1



2

Cl. 11-01 **130 638** 25.05.2004  
 8 Design – Schmuckstücke  
 Hinterleger: Magic Button AG, Talackerstrasse 5,  
 8152 Glattbrugg  
 Designer: Ling Helsdon, Rüslikon  
 Vertreter: Isler & Pedrazzini AG, 8023 Zürich  
 Ende aufgeschobene Publikation

1

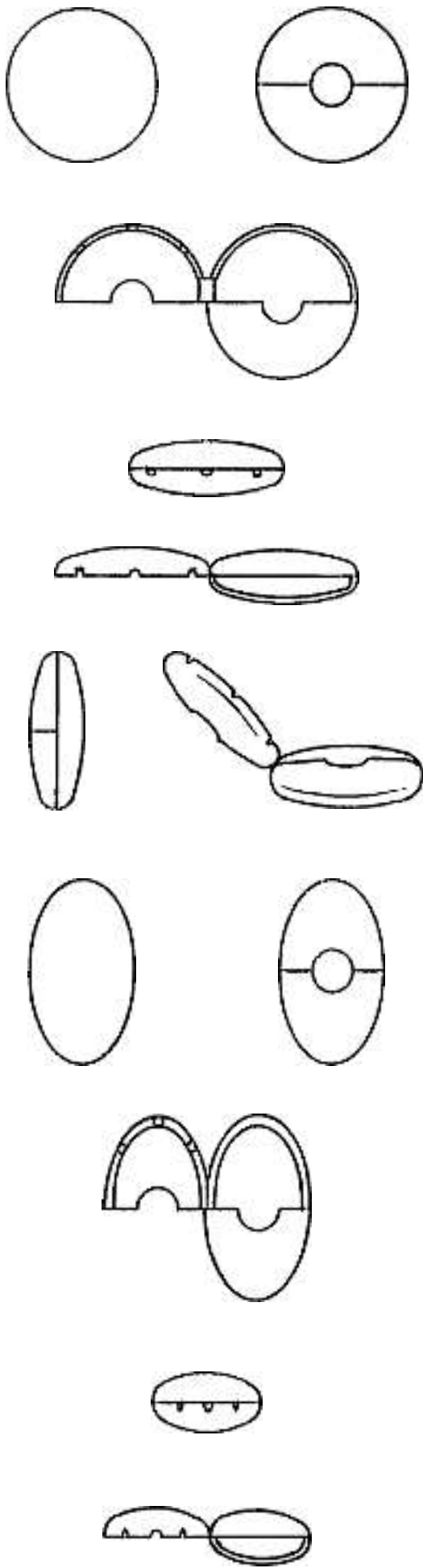

2

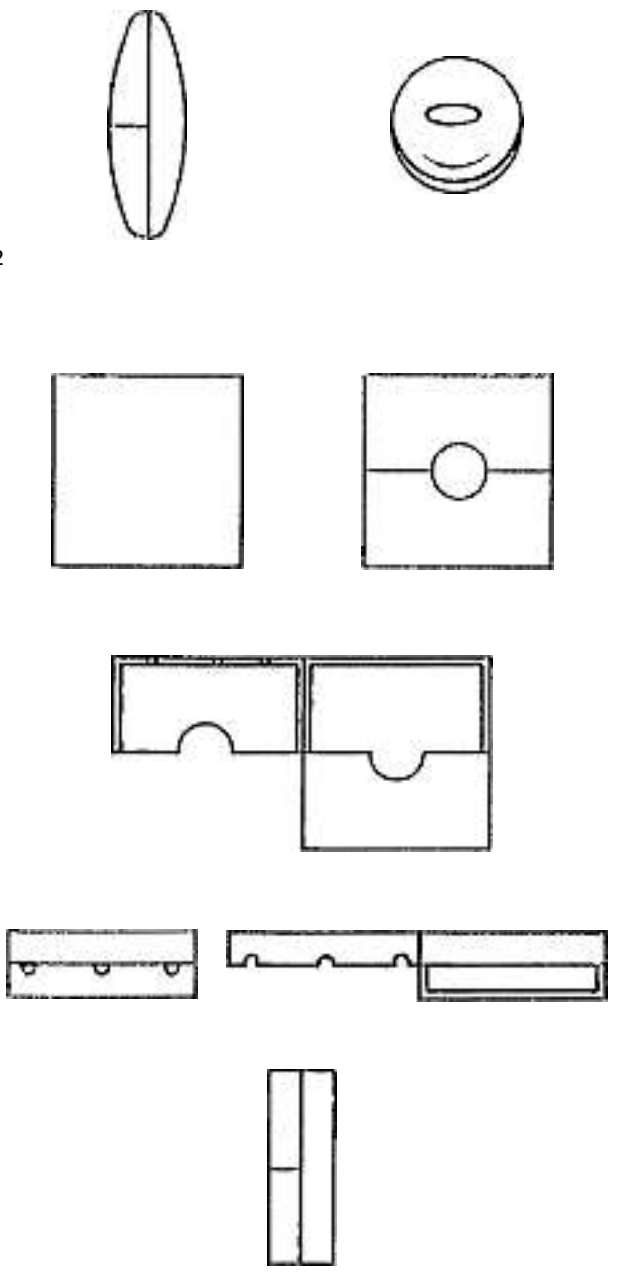

3

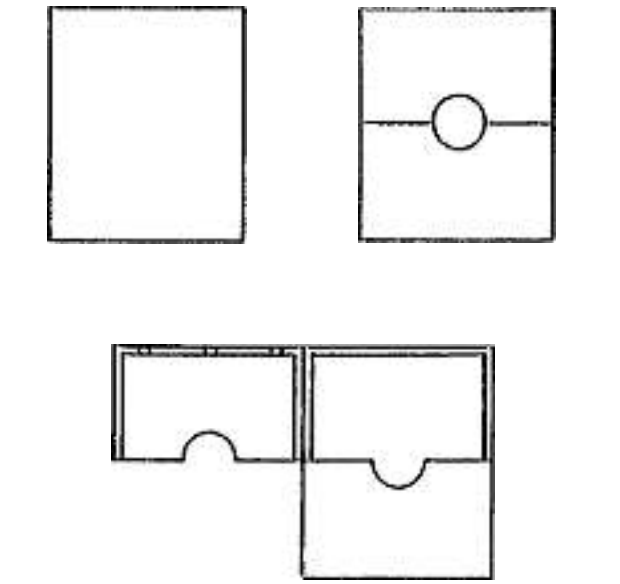

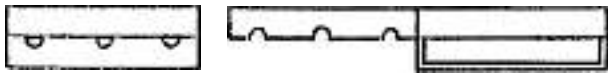

4

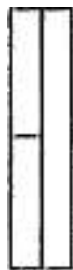
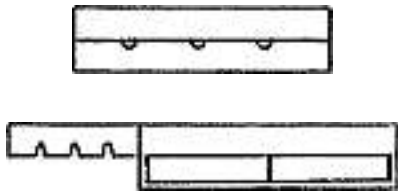
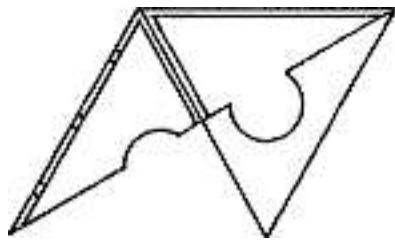
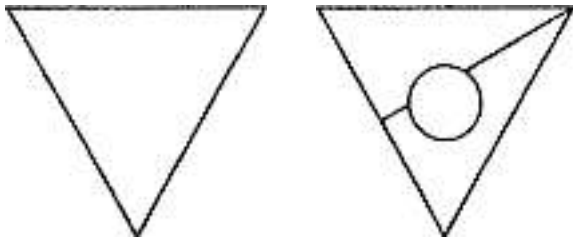

5

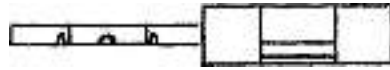
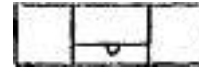
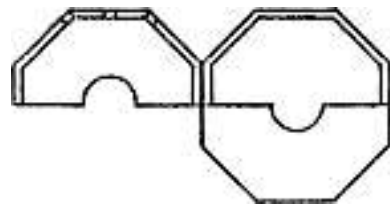
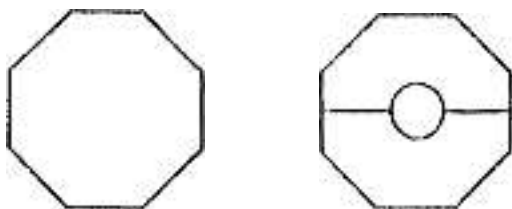

6

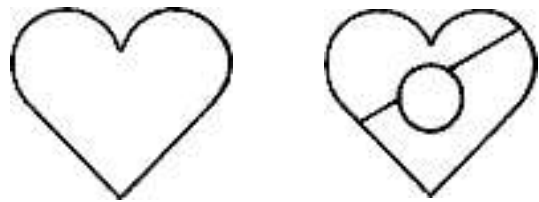

7

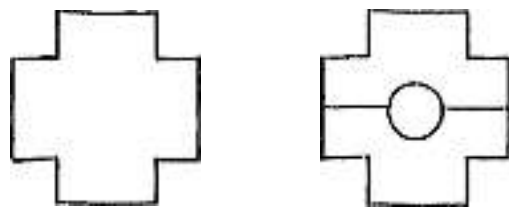

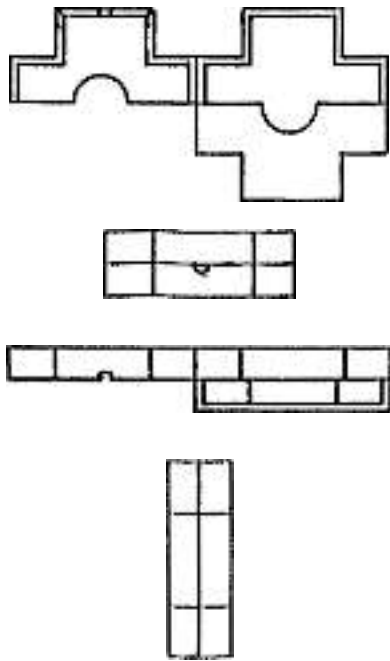

8

Cl. 07-02 **131 758** 10.05.2005  
 1 design – machine pour boissons  
 Déposant: Société des Produits Nestlé SA, 1800 Vevey  
 Designer: Rémy Jacquet, Le Locle; Yves Marmier, La Chaux-de-Fonds; Pierre Struzka, Lausanne; William Kohler, La Chaux-de-Fonds; Camille Mairot, Valdahon  
 Mandataire: Nestec S.A., 1800 Vevey  
 Fin de la période ajournement de la publication



FL 57479

Cl. 02-02 **131 972** 01.07.2005  
 1 Design – Brandschutzjacke  
 Hinterleger: CONSULTIV AG, Wieshofstrasse 117, 8408 Winterthur  
 Designer: Ivo Ernst, Egg

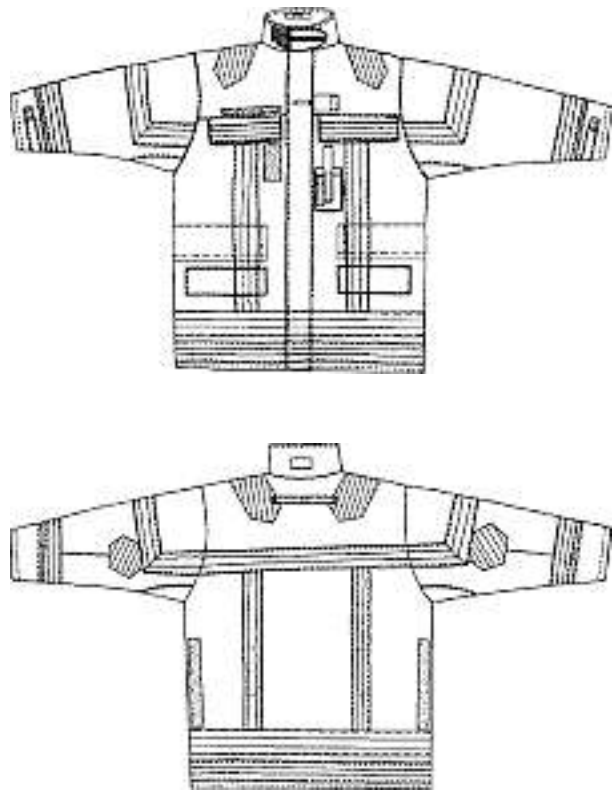

BSJ FL 1760B

Cl. 04-02 **131 973** 19.07.2005  
 1 Design – Zahnbürste  
 Hinterleger: GlaxoSmithKline Consumer Healthcare GmbH & Co. KG, Bussmatten 1, Bühl, DE  
 Designer: Christoph Geiberger, Königswinter  
 Vertreter: Isler & Pedrazzini AG, 8023 Zürich  
 Priorität: GB, 21.01.2005

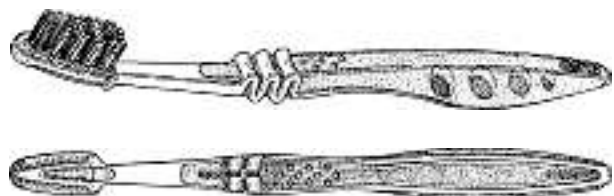

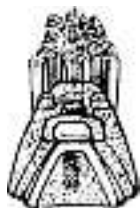

M13040

Cl. 06-01 131 974 27.06.2005  
 1 Design – Stuhl  
 Hinterleger: First Market AG, c/o Fiechter Demirci  
 Maus & Mann AG, Bahnhofstrasse 8, 9000 St. Gallen  
 Designer: Lars Böttcher, Hamburg  
 Vertreter: Felber & Partner AG, 8034 Zürich



1

Cl. 06-01 131 975 06.07.2005  
 4 design – chaise, bancs  
 Déposant: Julien Descombes, 10, passage Daniel Baud-Bovy,  
 1205 Genève; Carlos Lopez, 31, route de Malagnou,  
 1208 Genève  
 Mandataire: Compagnie des Rues, J. Descombes & C. Lopez,  
 1203 Genève

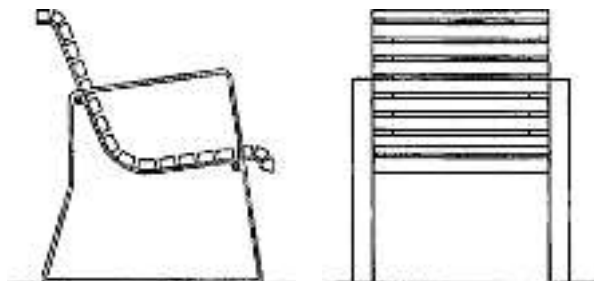

1



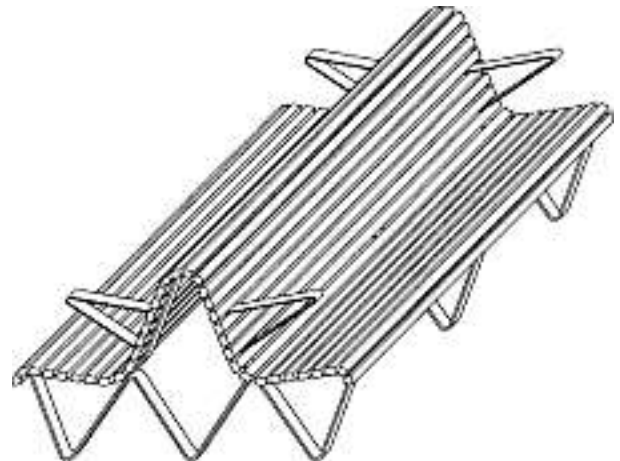
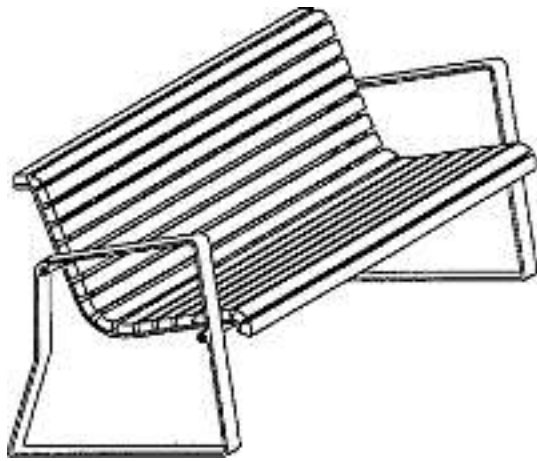

3

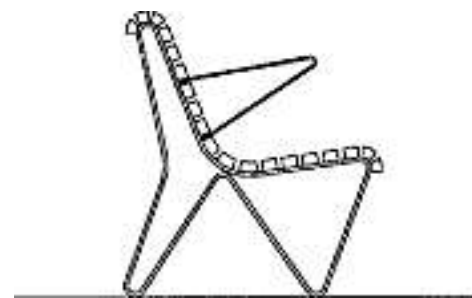
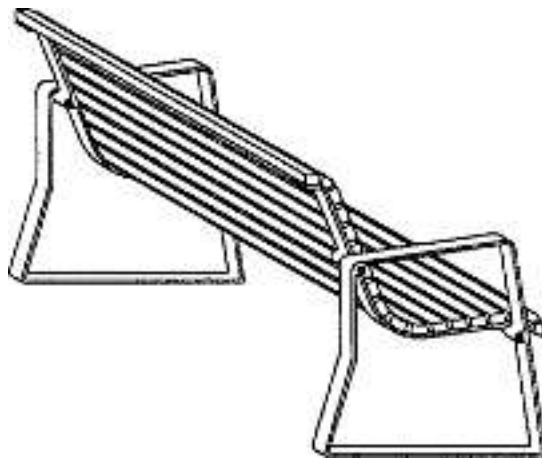

2

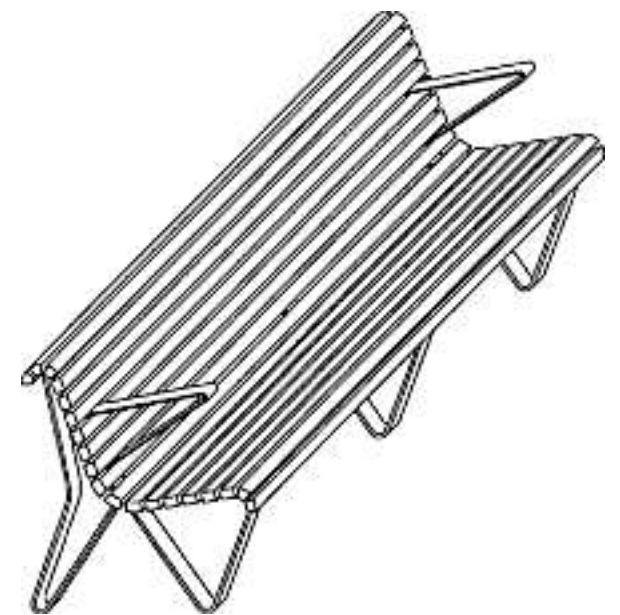
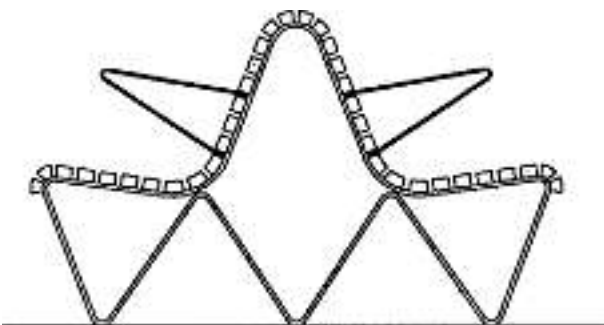



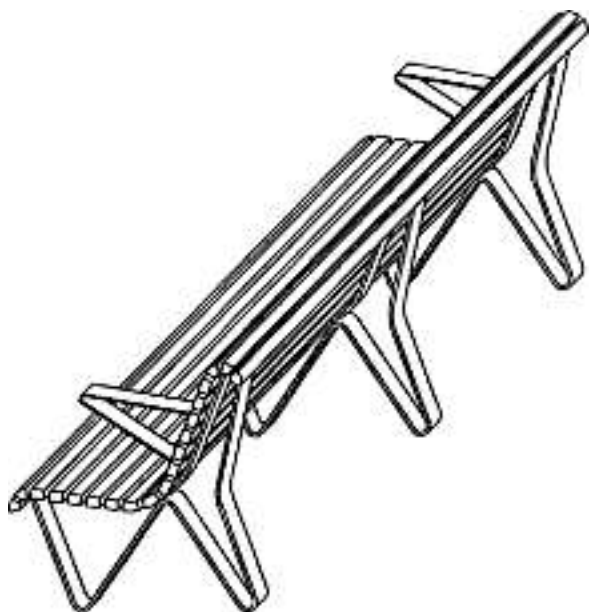

4

Cl. 06-01 131 976 12.07.2005  
 1 Design – Stuhl  
 Hinterleger: Möbelfabrik Seon AG, Aarauerstrasse 4,  
 5703 Seon  
 Designer: Norbert Beck, Markdorf



Prado F

Cl. 06-02, 06-06 131 977 07.07.2005  
 4 Design – Bett und Möbelteile  
 Hinterleger: Maro Möbel AG, Landstrasse 4,  
 6418 Rothenthurm  
 Designer: Pirmin Lüönd, Rothenthurm



32



42

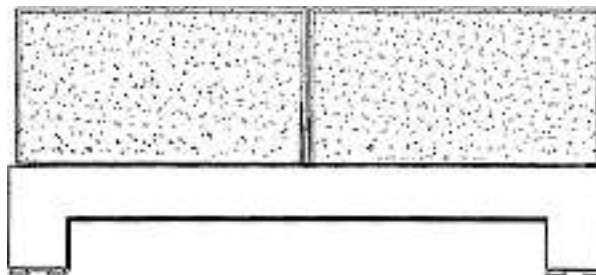

882/828

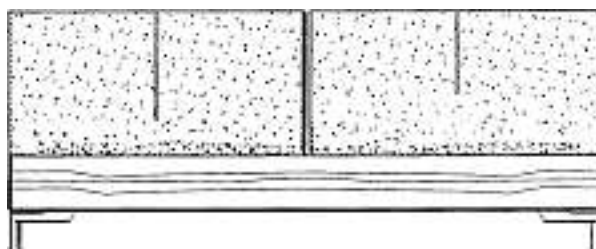

888/823

Cl. 06-03 131 978 04.07.2005  
 1 Design – Servicebar  
 Hinterleger: Fachhochschule Aargau Nordwestschweiz,  
 Departement Gestaltung und Kunst, Bahnhofstrasse 102,  
 5000 Aarau  
 Designer: Mathias Schnyder, Erlinsbach; Samuel Köppel,  
 Zürich; Pascal Müller, Zürich



2005/001

Cl. 06-03 131 979 06.07.2005  
1 Design – Tischblatt  
Hinterleger: Hugo Ruf, Treppacker 20, 4616 Kappel SO

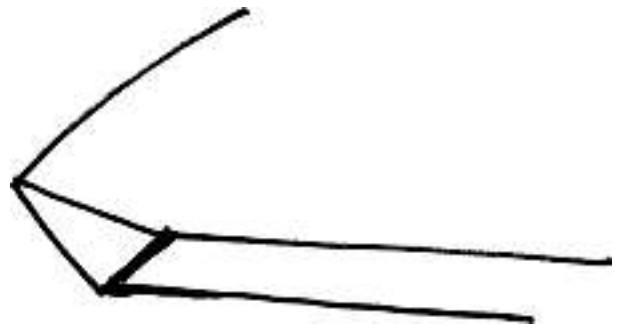
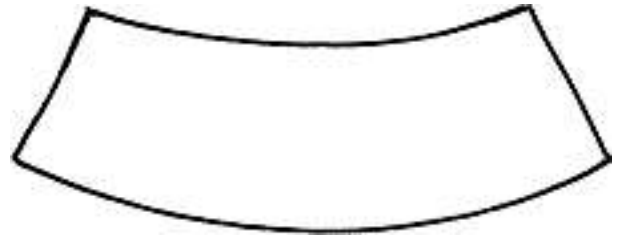

Fabienne 2005

Cl. 06-03 131 980 06.07.2005  
1 Design – Tisch  
Hinterleger: Möbelfabrik Seon AG, Aarauerstrasse 4,  
5703 Seon  
Designer: Hans Dössegger, Seon; Pius Baumgartner, Seon





DIVA



Cl. 06-04 **131 981** 12.07.2005  
 2 Design – Schrank, Regal  
 Hinterleger: Daniel Graf, Rietlirain 29, 8713 Uerikon

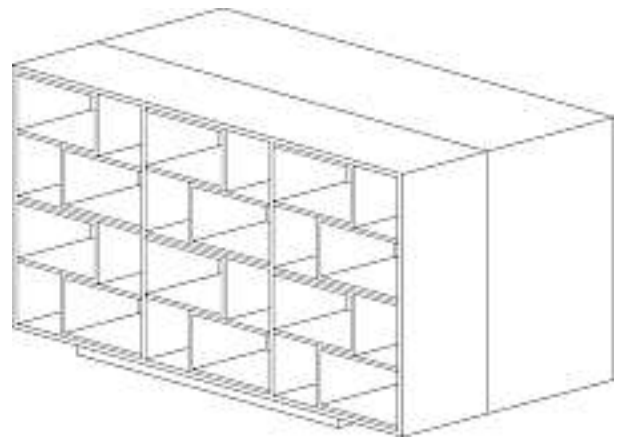
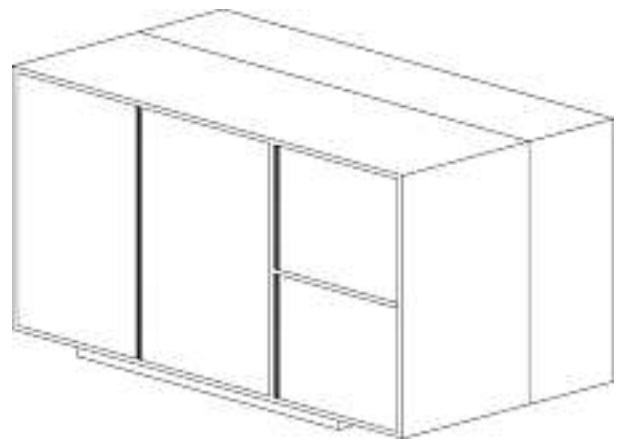

Loft-Box I

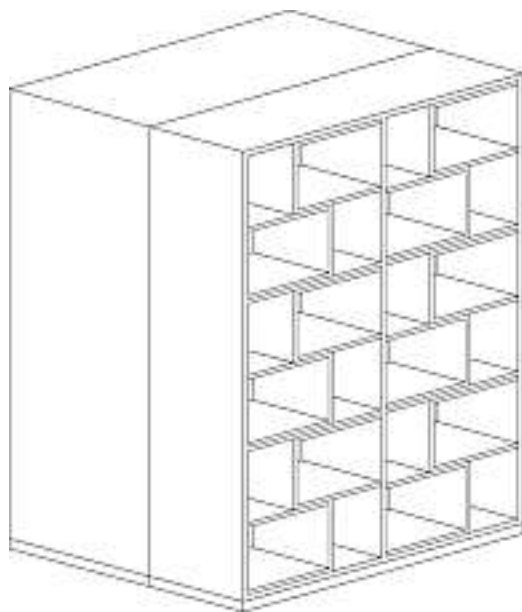
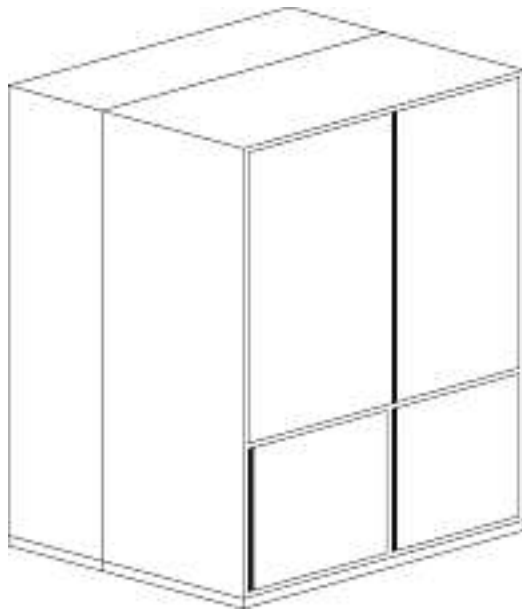

Loft-Box II



Nine to Five O'Clock Tea

Cl. 07-01 **131 982** 01.07.2005  
 1 Design – Teekrug  
 Hinterleger: Basil Dubs, Sihlhölzlistrasse 5, 8002 Zürich

Cl. 07-01 **131 983** 01.07.2005  
 6 Design – Bemusterungen für Teller  
 Hinterleger: Mila GmbH, Andernacher Strasse 31,  
 Nürnberg, DE  
 Designer: Robert Köhler, Nürnberg  
 Vertreter: M.I.L.A. Design- und Geschenkartikel GesmbH &  
 Co. KG, Wien (A), Zweigniederlassung Wald, 3086 Engelsberg

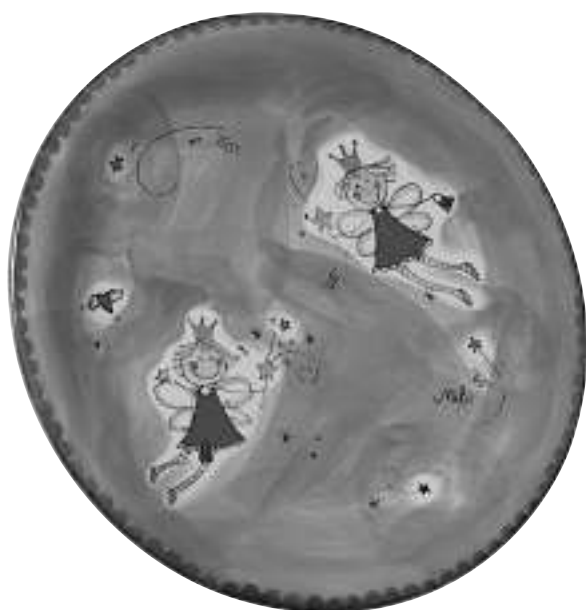

8435



8490



8488



8491



8489



8492

Cl. 07-01 131 984 01.07.2005  
 8 Design – Weingläser und Sektglas  
 Hinterleger: PI-DESIGN AG, Kantonsstrasse 100,  
 6234 Triengen  
 Designer: Jorgen Bodum, St. Niklausen  
 Vertreter: Isler & Pedrazzini AG, 8023 Zürich  
 Priorität: DK, 11.01.2005  
 Beschreibung des Designs: Die Gläser weisen einen hohlen  
 Stiel auf. Eine Glasschicht bedeckt das obere Ende des Stiels,  
 so dass keine Flüssigkeit in den Stiel kann.



1





2



3





4



5





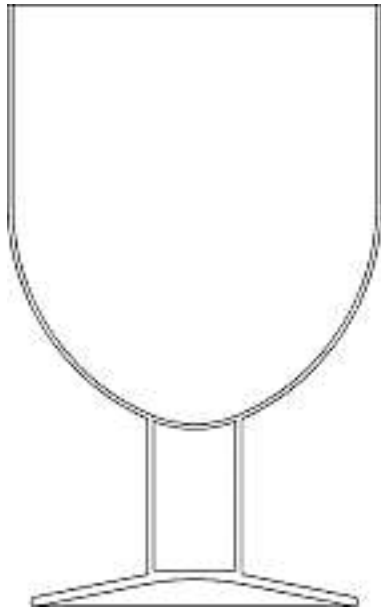

6

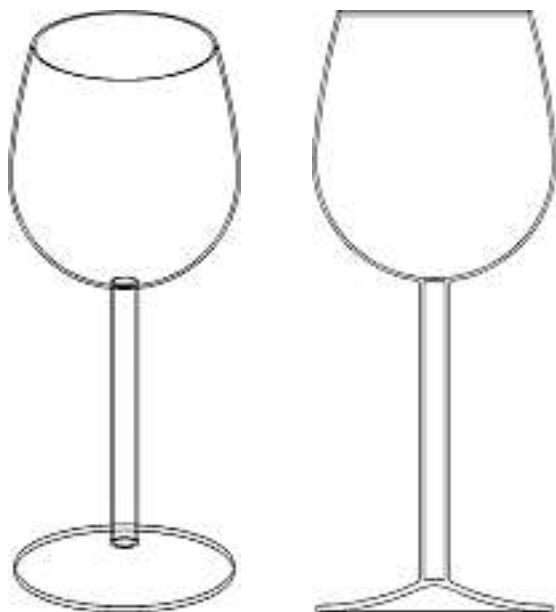

7

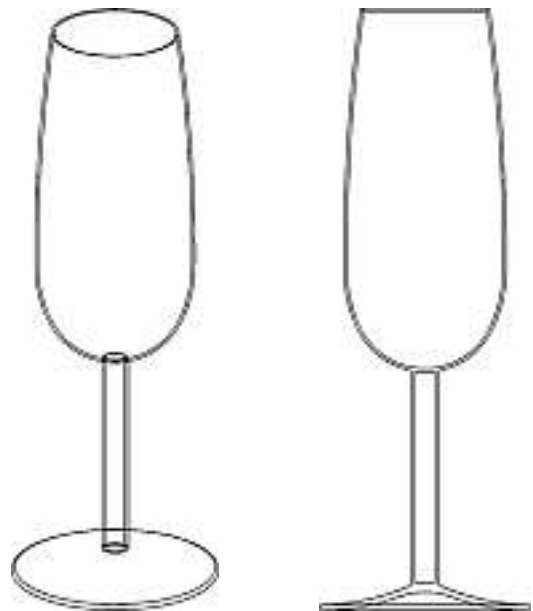

8

Cl. 07-01 131 985 04.07.2005  
3 Design – Behälterverschluss mit Klappe  
Hinterleger: Dart Industries Inc., 14901 S. Orange Blossom  
Trail, Orlando / FL, US  
Designer: Stig Lillelund, Gentofte; Jakob Heiberg,  
Charlottenlund; Hanne Dalsgaard Jeppesen, Holte; Robert  
H. C. M. Daenen, Herne  
Vertreter: A. Braun, Braun, Hérítier, Eschmann AG,  
Patentanwälte, 4051 Basel

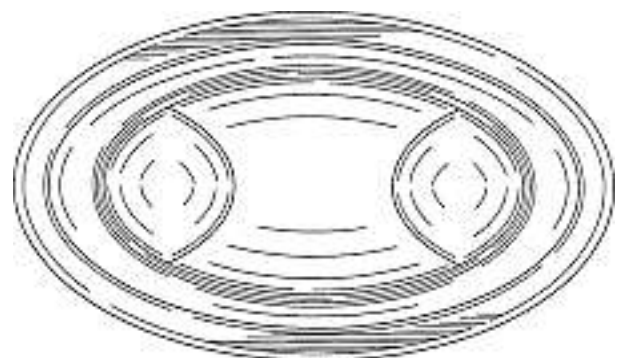
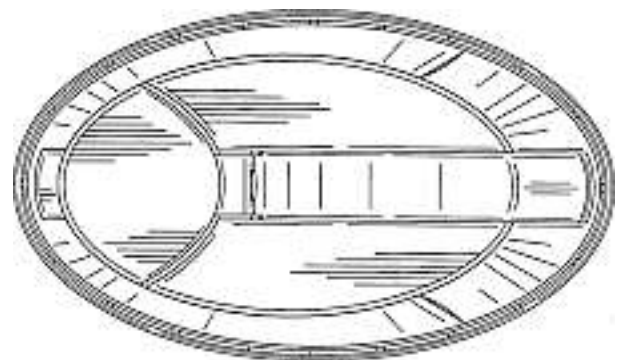
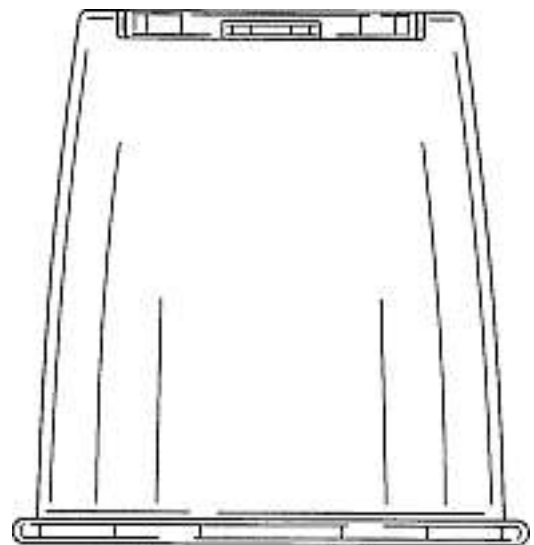
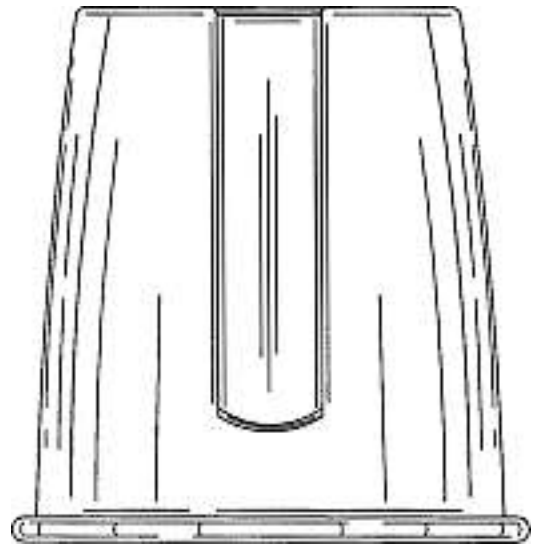
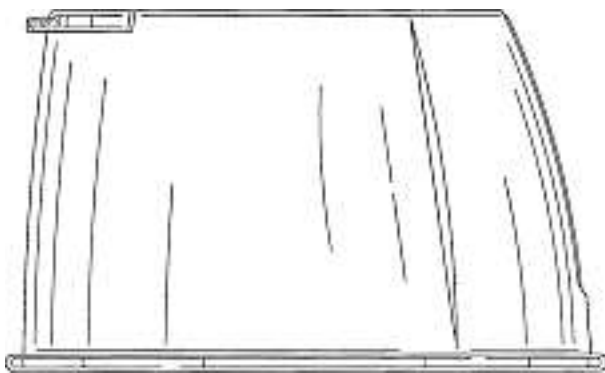
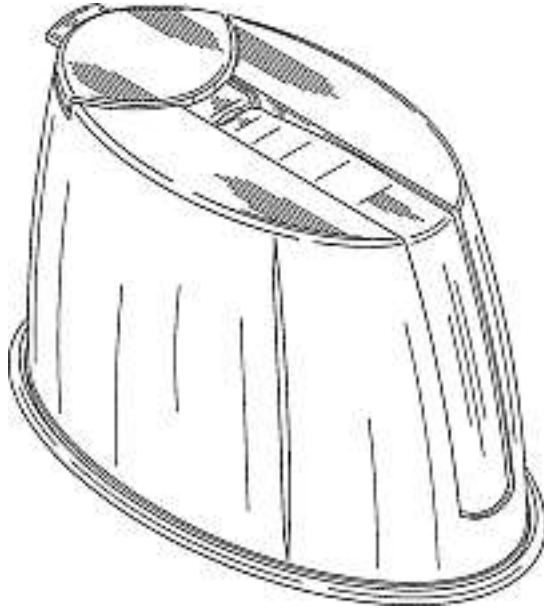

1

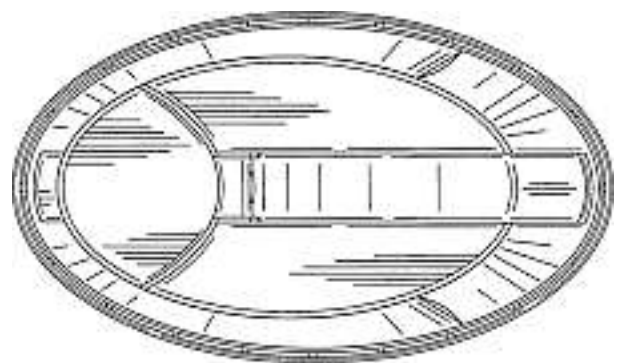
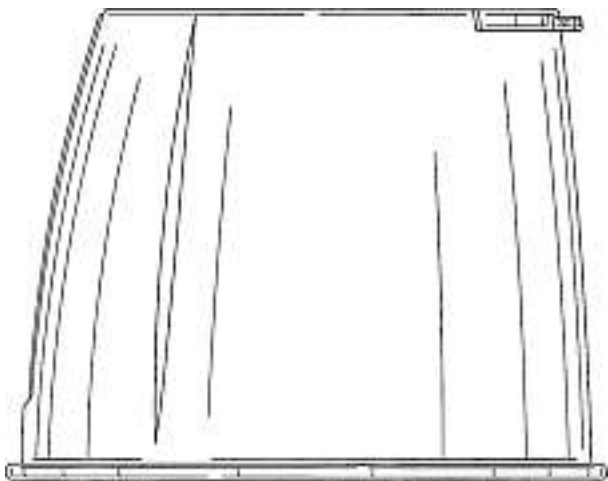
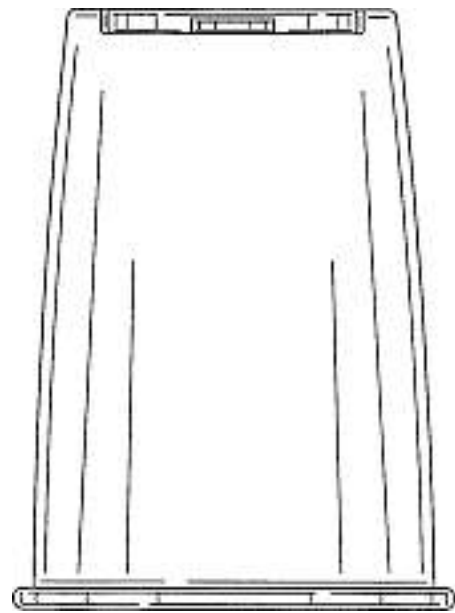
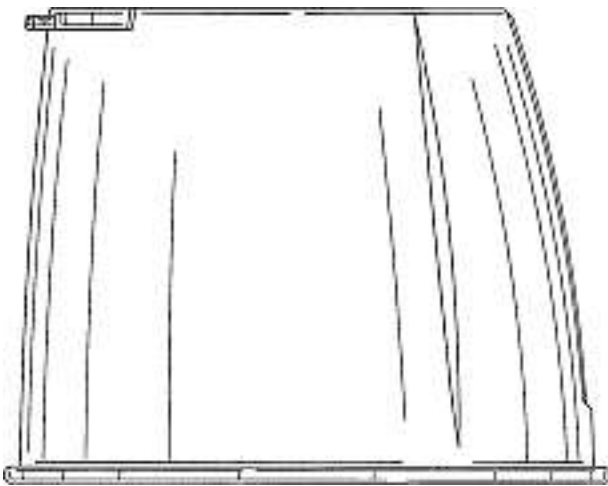
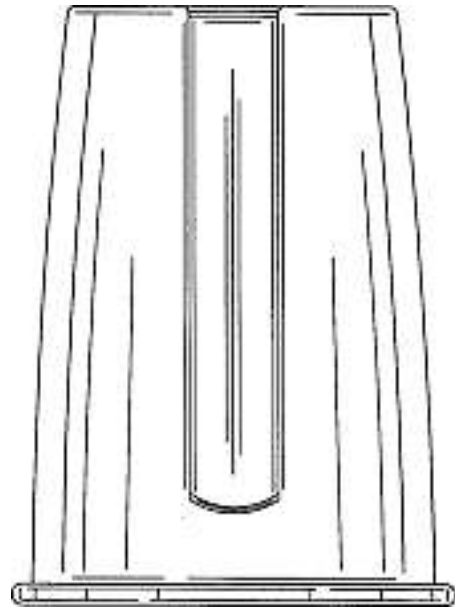
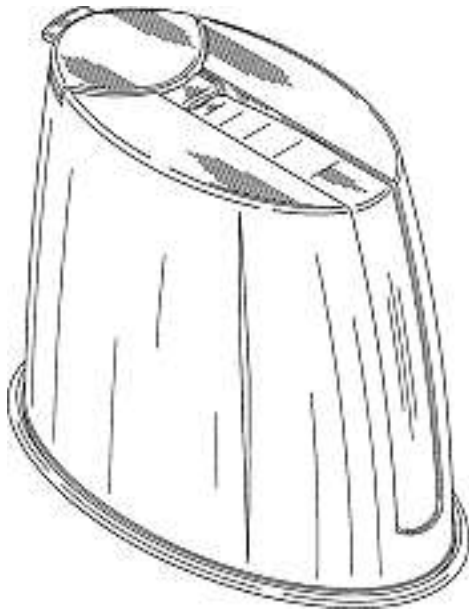

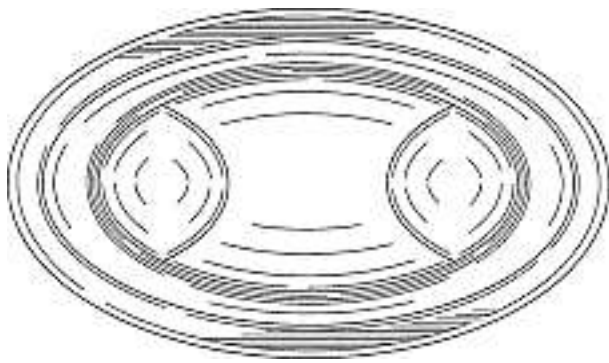

2

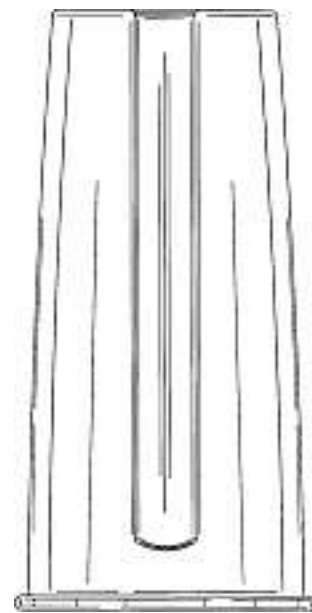
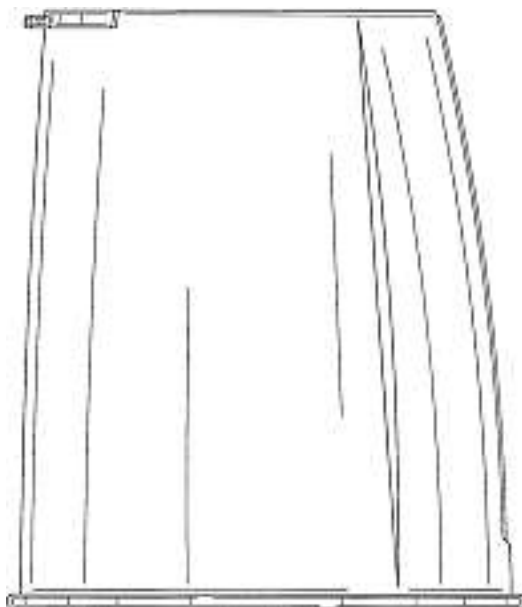
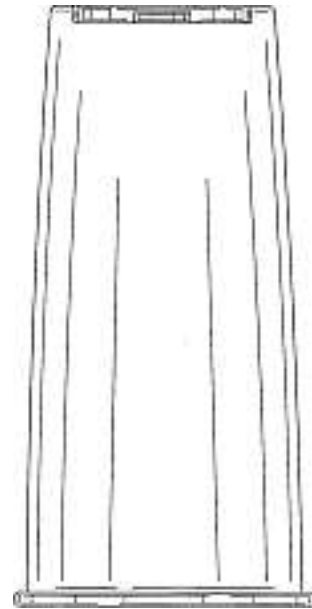
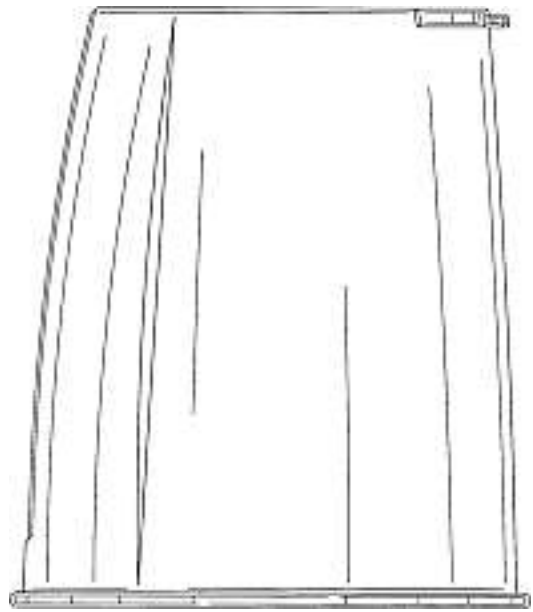

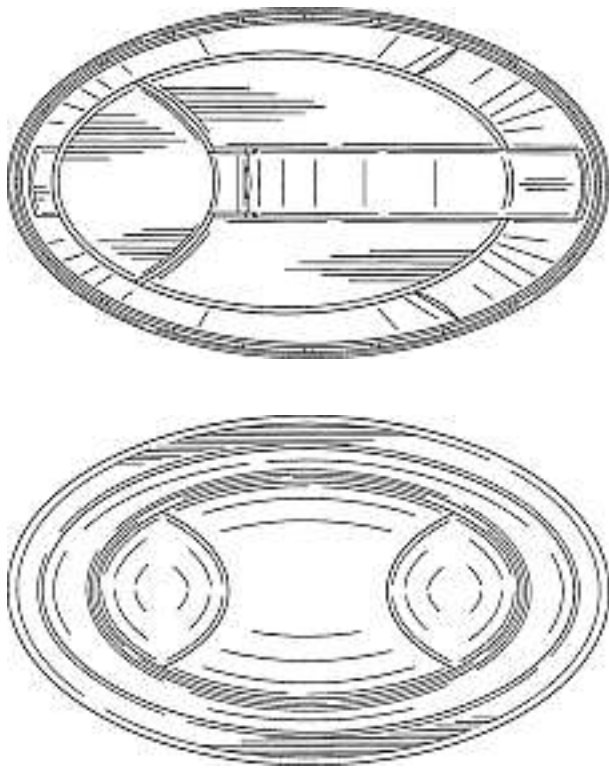

3

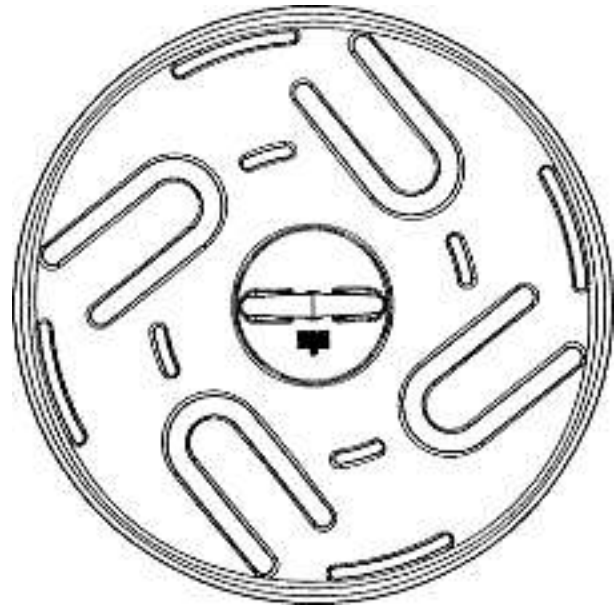
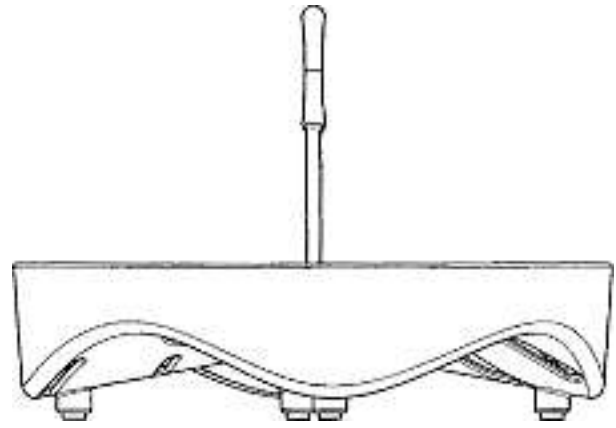

Cl. 07-02                      **131 986**                      01.07.2005  
 1 Design – Schoppensterilisator  
 Hinterleger: Kuhn Rikon AG, 8486 Rikon im Tösstal  
 Designer: Philipp Beyeler, Bern  
 Vertreter: Isler & Pedrazzini AG, 8023 Zürich

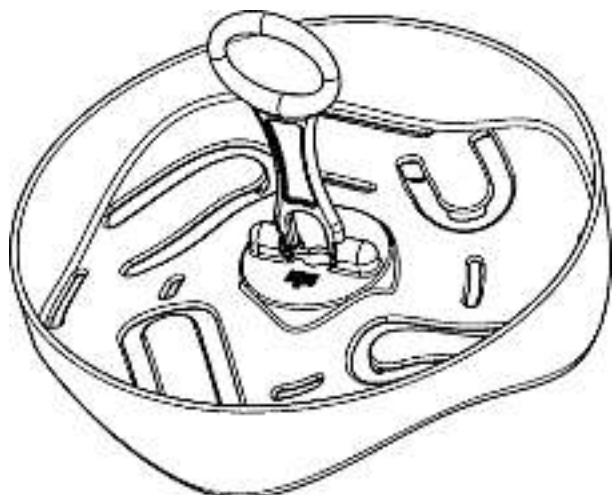
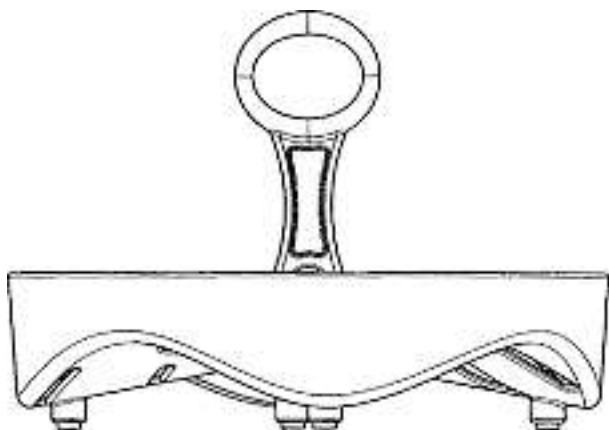

M13043

Cl. 07-02 131 987 04.07.2005  
 1 Design – Kaffeemaschine  
 Hinterleger: Fachhochschule Aargau Nordwestschweiz,  
 Departement Gestaltung und Kunst, Bahnhofstrasse 102,  
 5000 Aarau  
 Designer: Mathias Schnyder, Erlinsbach; Samuel Köppel,  
 Zürich; Pascal Müller, Zürich



2005/002

Cl. 07-02 131 988 11.08.2005  
 1 design – parties de machines à café/porte-capsule  
 Déposant: Société des Produits Nestlé SA, 1800 Vevey  
 Designer: Jean-Luc Denisart, Cully; Sébastien Dassi,  
 Neuchâtel; Yves Marmier, La Chaux-de-Fonds; Pierre Struzka,  
 Lausanne  
 Mandataire: Nestec S.A., 1800 Vevey





FL 58389

Cl. 08-07 **131 989** 11.07.2005  
 1 design – fermoir pour sac à main  
 Déposant: Cartier International B.V., Herengracht 436,  
 Amsterdam, NL  
 Designer: Cyrille Conrad, Saint-Lucien  
 Mandataire: Richemont Intellectual Property Services,  
 1201 Genève  
 Priorité: EM, 14.01.2005

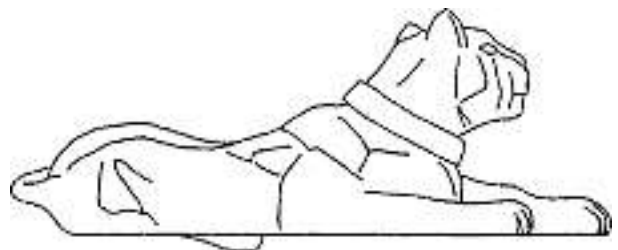
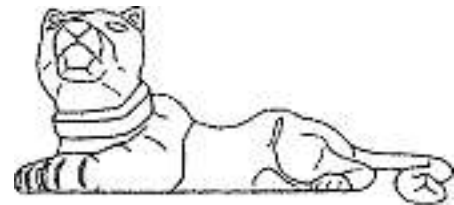
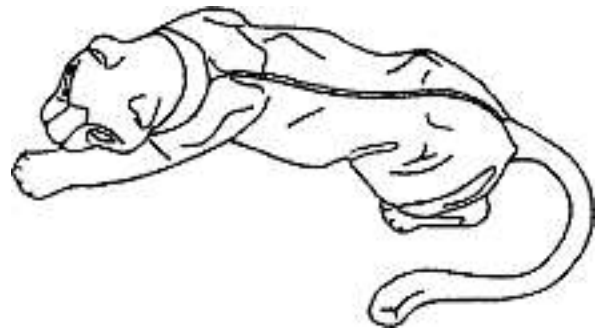
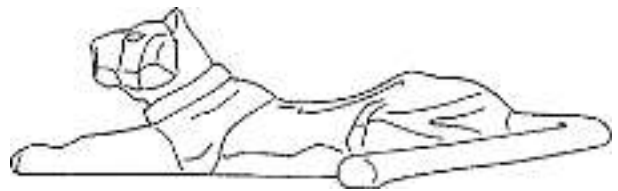
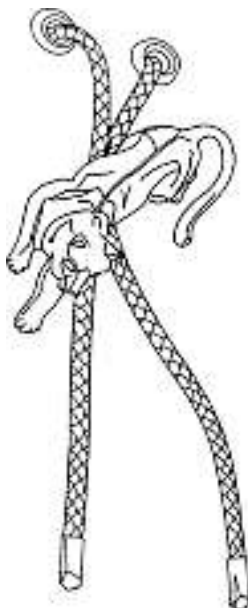

No 718

Cl. 09-01 **131 990** 11.07.2005  
 3 Design – Verpackungsbemusterungen  
 Hinterleger: Werner Buerge, Dorfstrasse 44, 4665 Oftringen;  
 Margareta Baldenweg, Baldismattweg 1, 5022 Rombach  
 Vertreter: Werner Buerge, 4665 Oftringen



2



1



3



Cl. 09-03 131 991 30.06.2005  
 1 Design – Verpackung  
 Hinterleger: Seetal Schaller AG, Wildschachen,  
 5201 Brugg AG  
 Designer: Barbara Schärer, Zürich  
 Vertreter: Troesch Scheidegger Werner AG, Patent- und  
 Markenanwälte, 8126 Zumikon



D300061

Cl. 09-03 131 993 04.07.2005  
 1 Design – Verpackung  
 Hinterleger: Ringler Informatik AG, Baarerstattstrasse 10,  
 6300 Zug  
 Designer: Marcel K. Ringler, Zug  
 Vertreter: Lenz & Staehelin, Rechtsanwälte, 8027 Zürich



0760-DES/CH

Cl. 09-03 131 992 01.07.2005  
 1 design – élément d'emballage  
 Déposant: Les Celliers de Vétroz SA, rue des Vignerons 33,  
 Case postale 56, 1963 Vétroz  
 Designer: Bernard Fontannaz, Stellenbosch

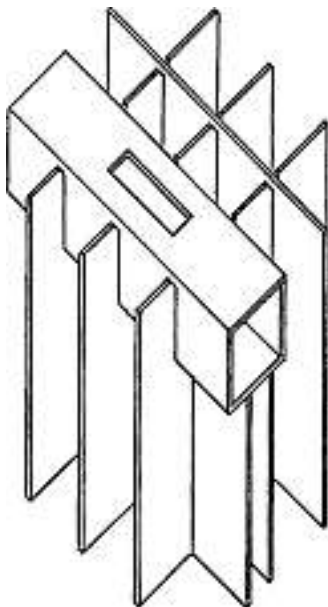

treize à la douzaine

Cl. 09-03 131 994 14.07.2005  
 1 Design – Behälter  
 Hinterleger: Bristol-Myers Squibb Company,  
 Lawrenceville-Princeton Road, Princeton, NJ, US  
 Designer: Stuart R. Kipperman, Evansville; Cathy O. Smay,  
 Newburgh  
 Vertreter: Isler & Pedrazzini AG, 8023 Zürich  
 Priorität: US, 02.02.2005

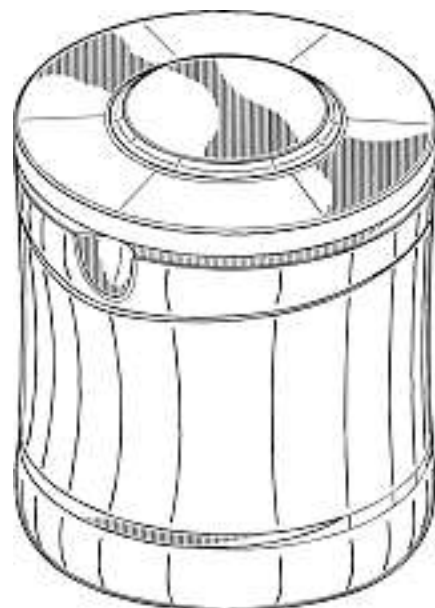

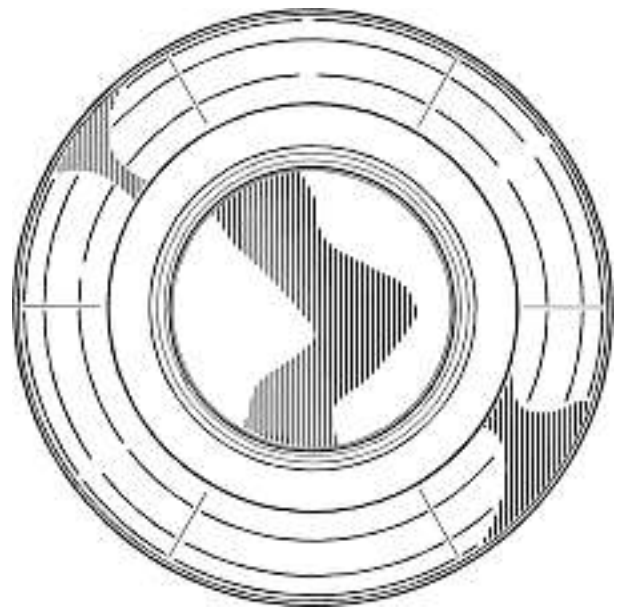
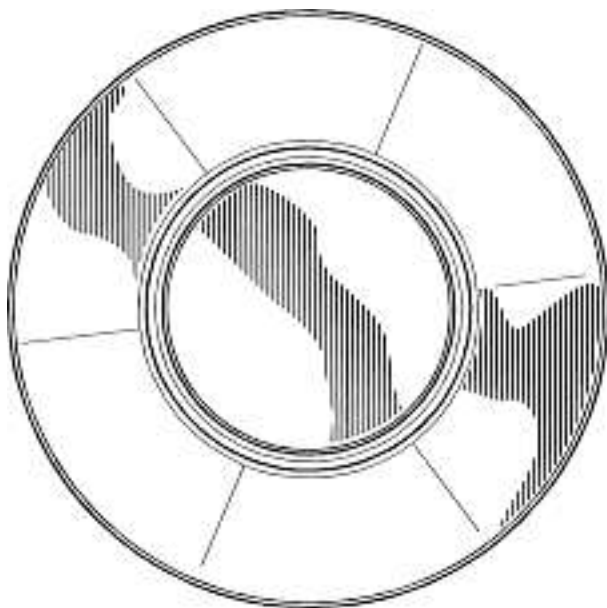
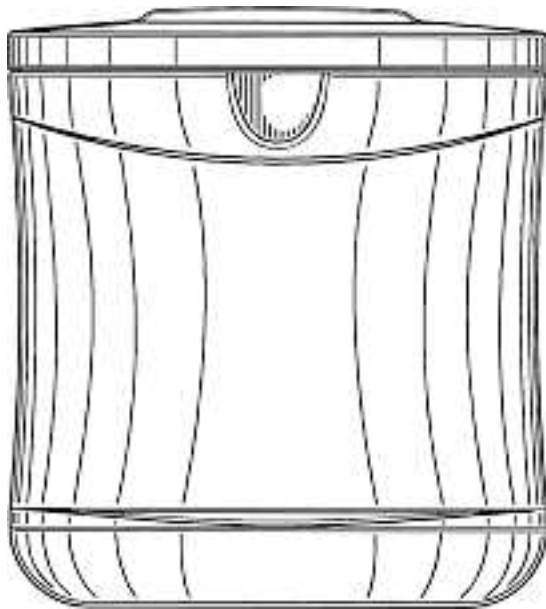
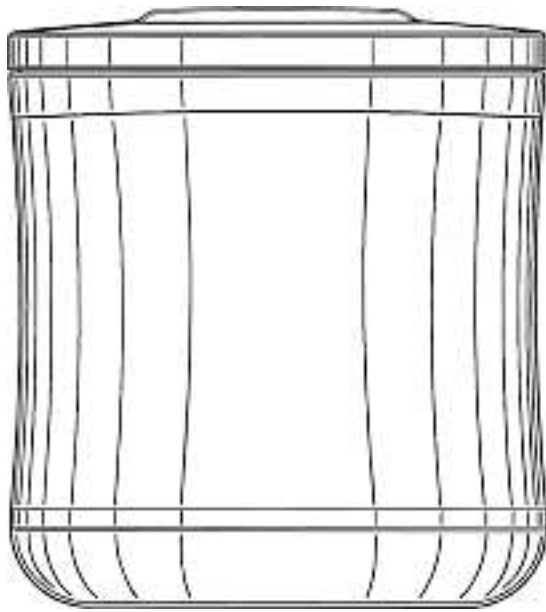

M13046

Cl. 09-03 131 995 14.07.2005  
 1 Design – Behälter  
 Hinterleger: Bristol-Myers Squibb Company,  
 Lawrenceville-Princeton Road, Princeton, NJ, US  
 Designer: Stuart R. Kipperman, Evansville; Cathy O. Smay,  
 Newburgh  
 Vertreter: Isler & Pedrazzini AG, 8023 Zürich  
 Priorität: US, 02.02.2005

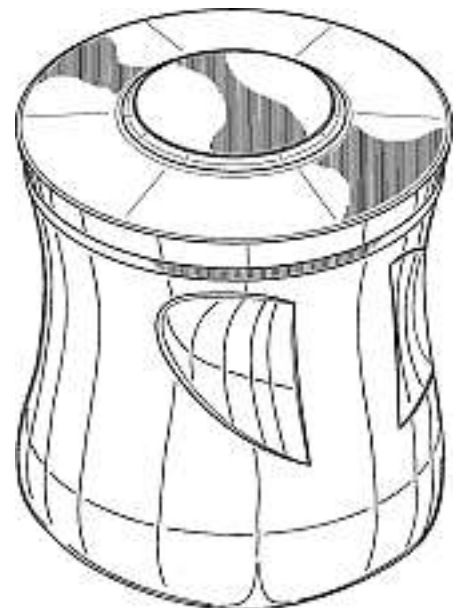

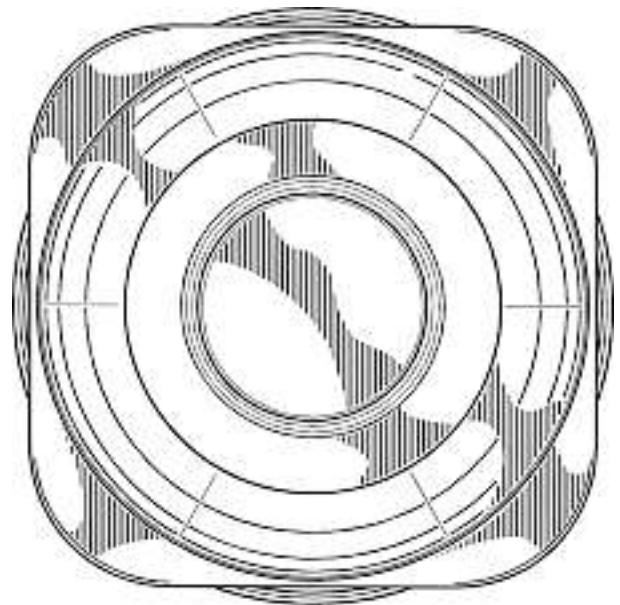
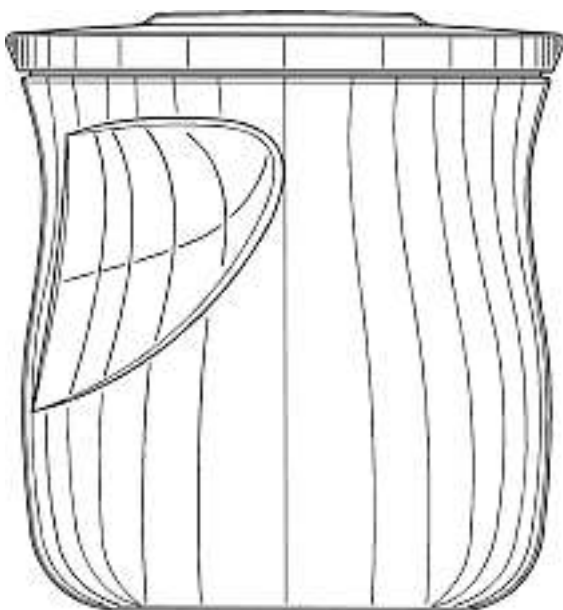
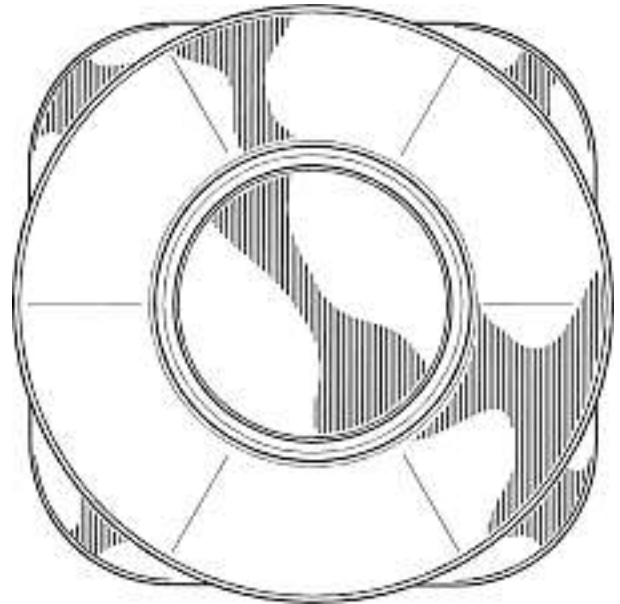
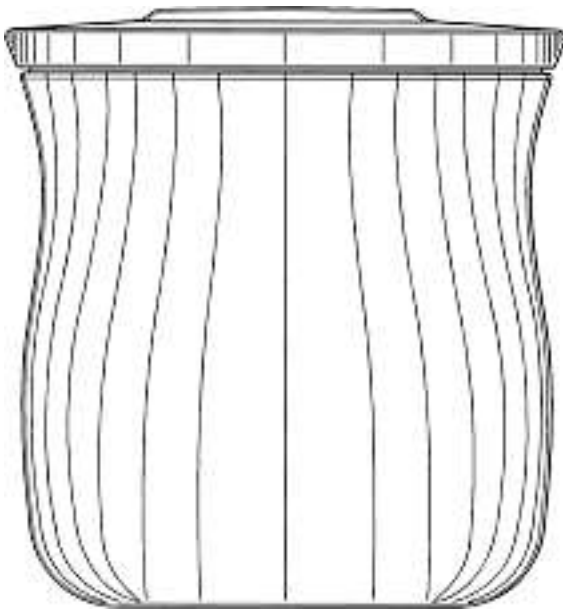
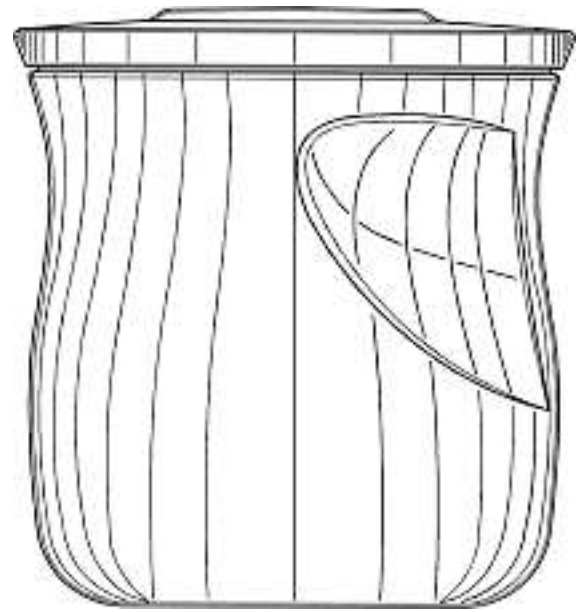
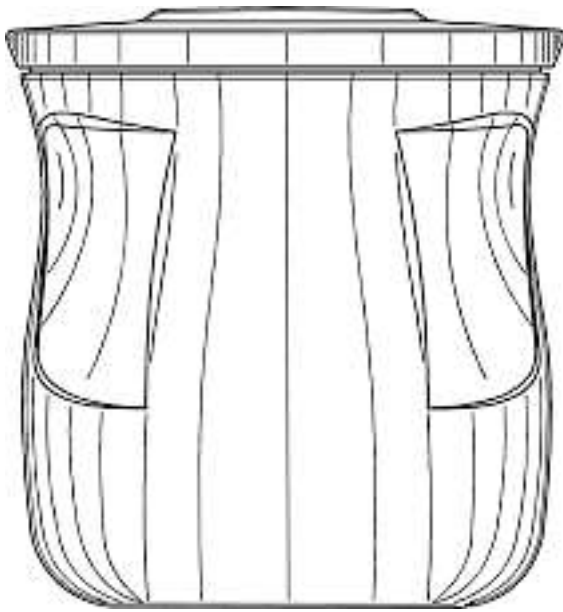

M13047

Cl. 09-03 131 996 14.07.2005  
1 Design – Behälter  
Hinterleger: Bristol-Myers Squibb Company,  
Lawrenceville-Princeton Road, Princeton, NJ, US  
Designer: Stuart R. Kipperman, Evansville; Cathy O. Smay,  
Newburgh  
Vertreter: Isler & Pedrazzini AG, 8023 Zürich  
Priorität: US, 02.02.2005

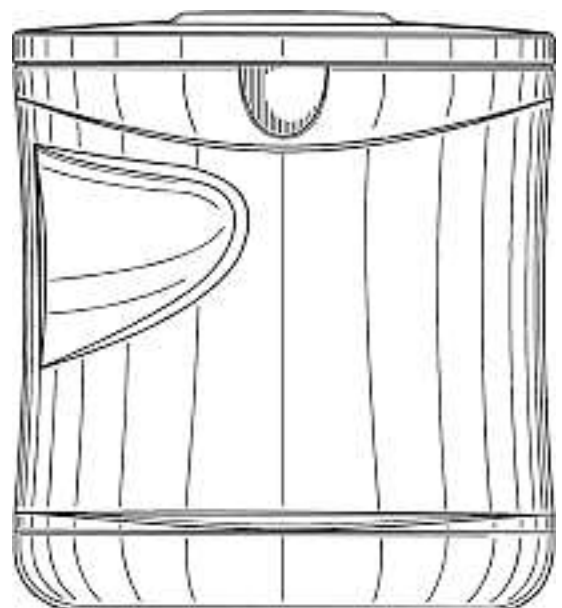
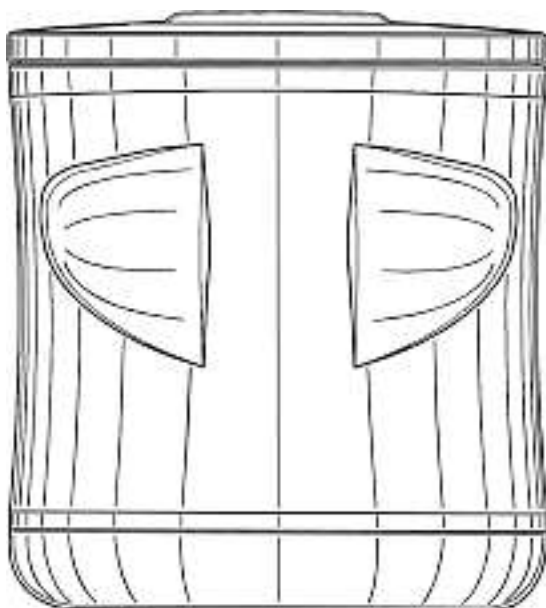
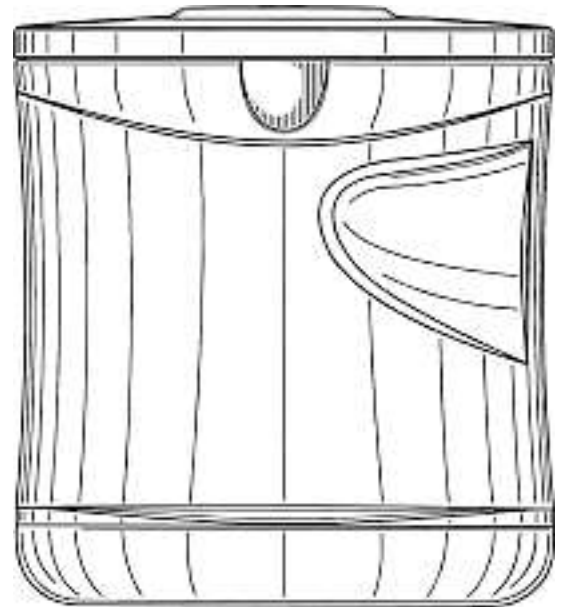
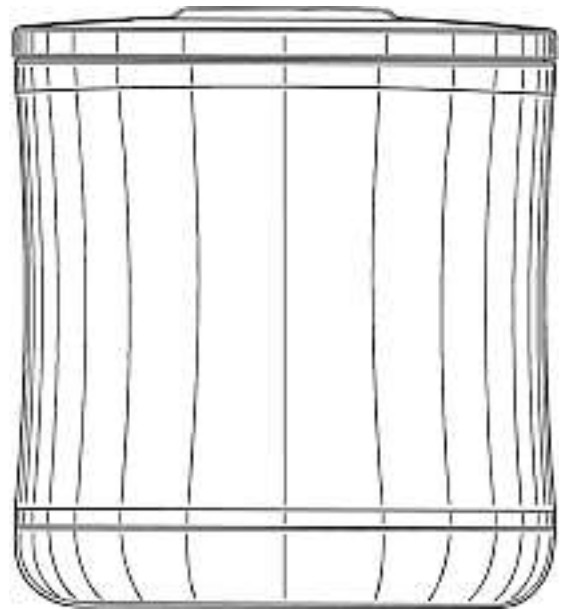
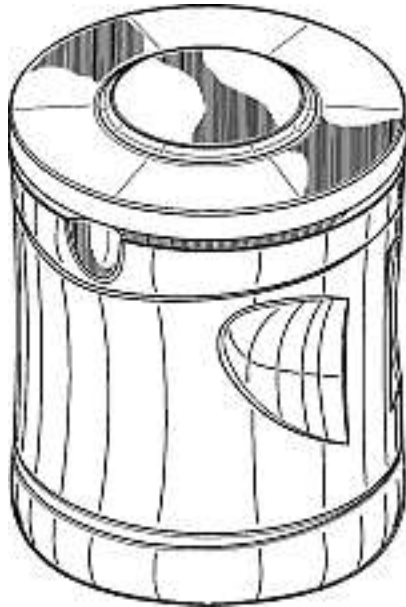

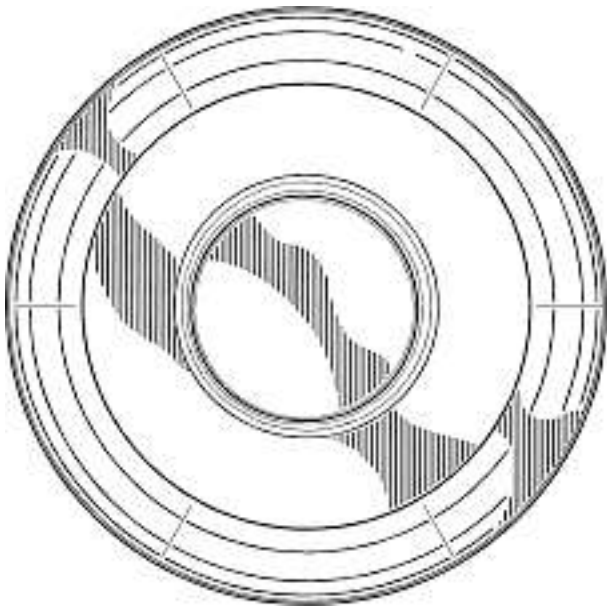
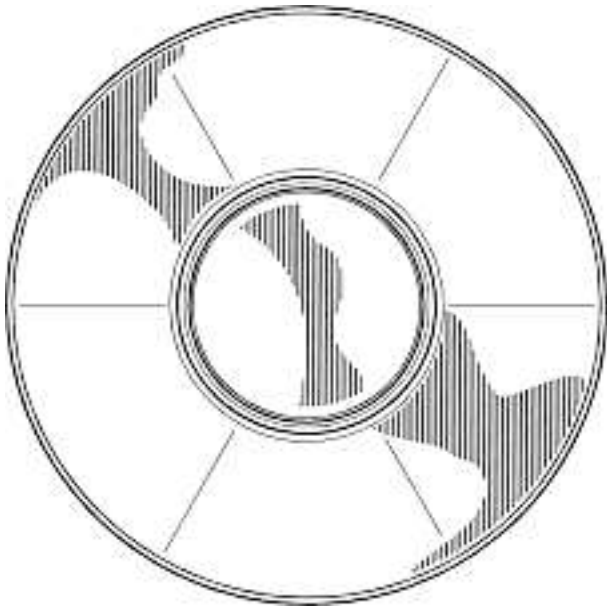

M13048

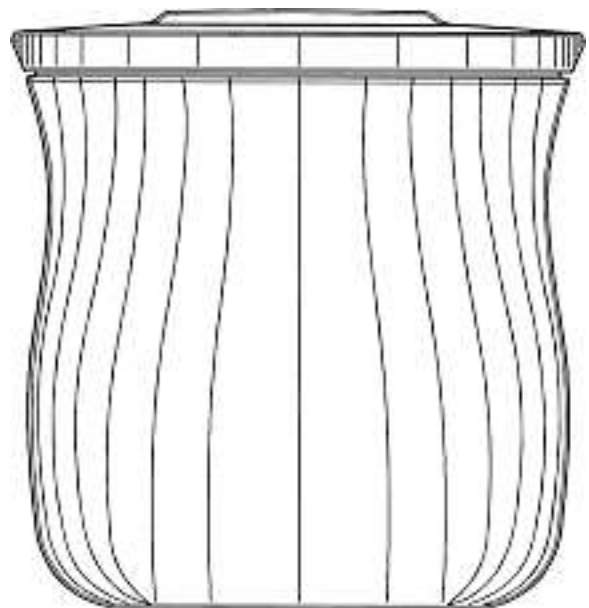
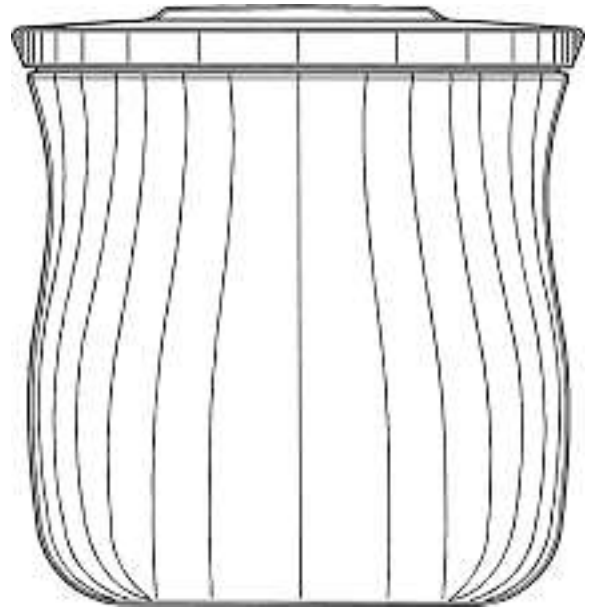
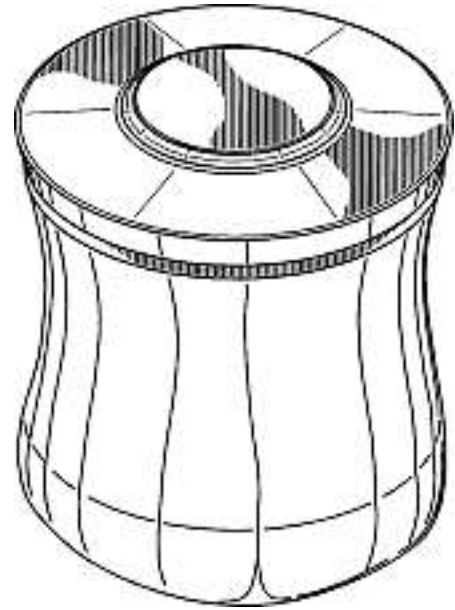

Cl. 09-03      **131 997**      14.07.2005  
 1 Design – Behälter  
 Hinterleger: Bristol-Myers Squibb Company,  
 Lawrenceville-Princeton Road, Princeton, NJ, US  
 Designer: Stuart R. Kipperman, Evansville; Cathy O. Smay,  
 Newburgh  
 Vertreter: Isler & Pedrazzini AG, 8023 Zürich  
 Priorität: US, 02.02.2005

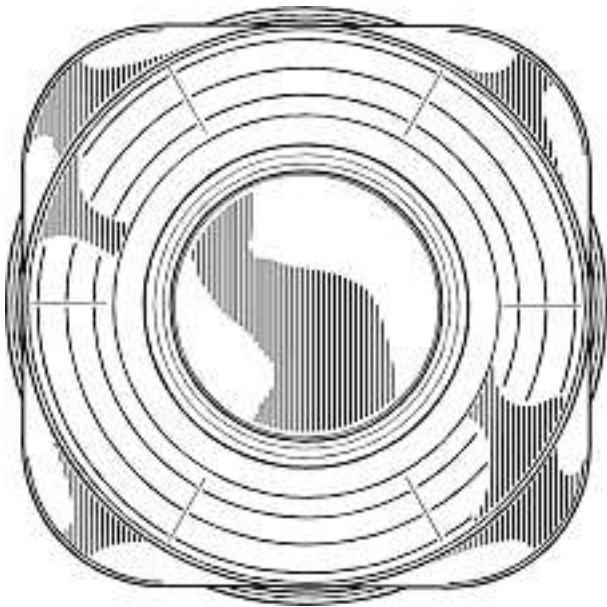
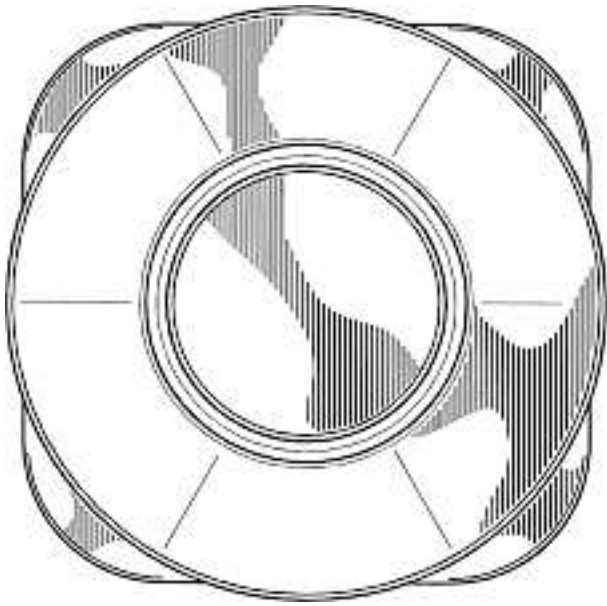

M13049

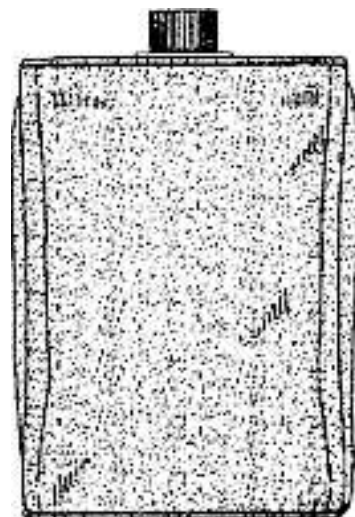
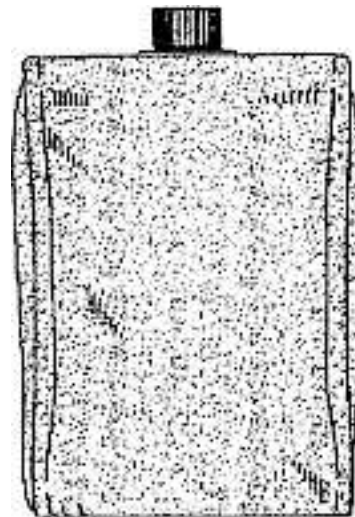

Cl. 09-05 131 998 12.07.2005  
2 Design – Getränkebeutel  
Hinterleger: SaddleSprings Beverage Company, Inc., 203  
Argonne Avenue, Long Beach, CA, US  
Designer: Ron Berman, Long Beach  
Vertreter: Schneider Feldmann AG, Patent- und  
Markenanwälte, 8039 Zürich  
Priorität: US, 24.01.2005; US, 24.01.2005

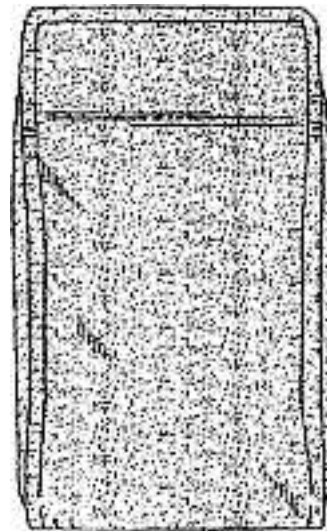
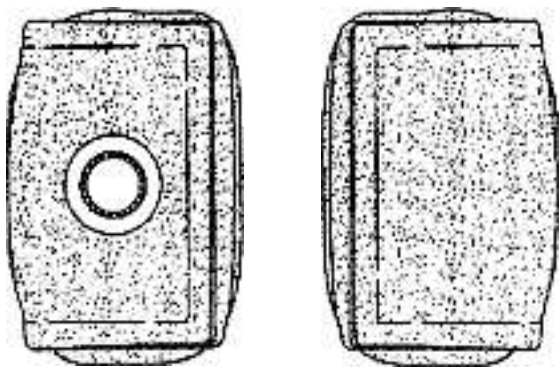
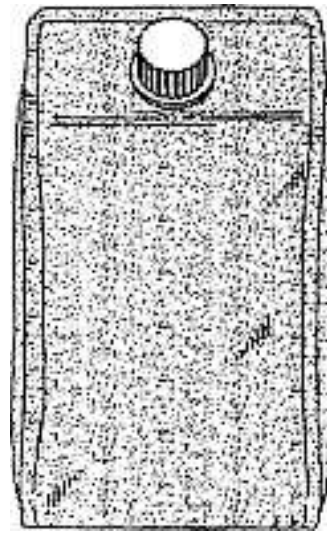
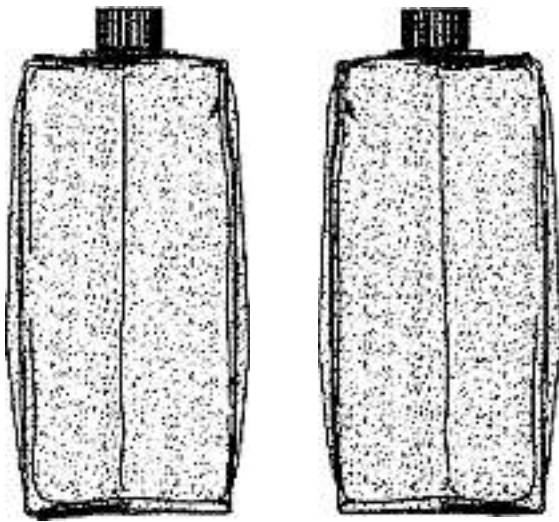

1

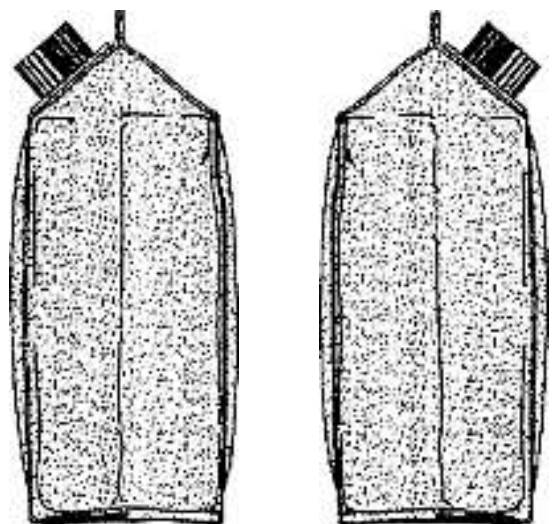
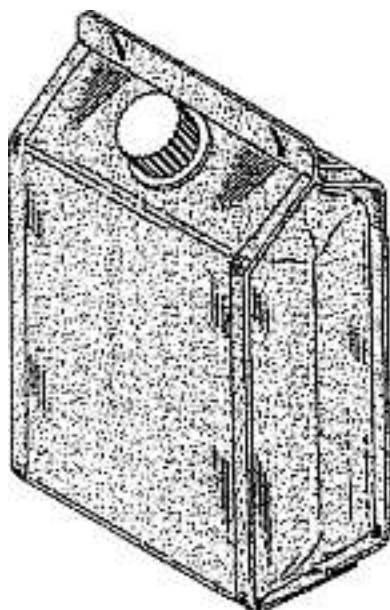

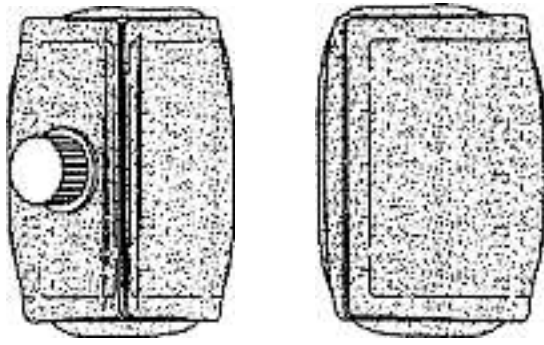

2

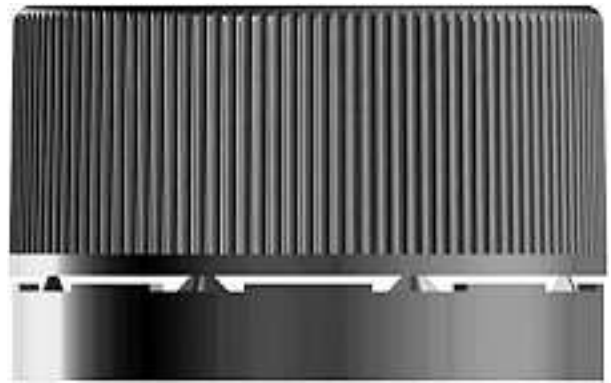

Cl. 09-07 131 999 20.06.2005  
10 Design – Verschlüsse  
Hinterleger: Creanova Universal Closures Ltd.,  
24 Bevis Marks, London, GB  
Designer: Rodney M. Druitt, Bath; Louis Lagler, Zürich  
Vertreter: Rentsch & Partner, 8022 Zürich



1



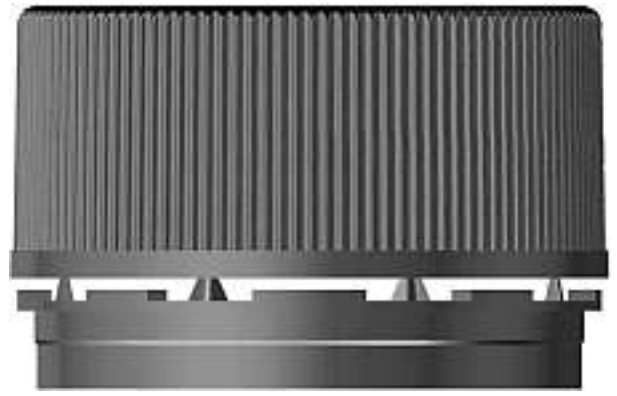

2

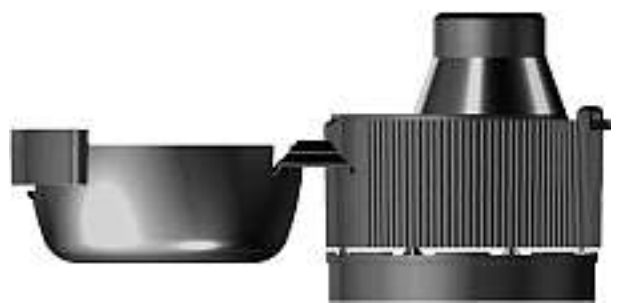
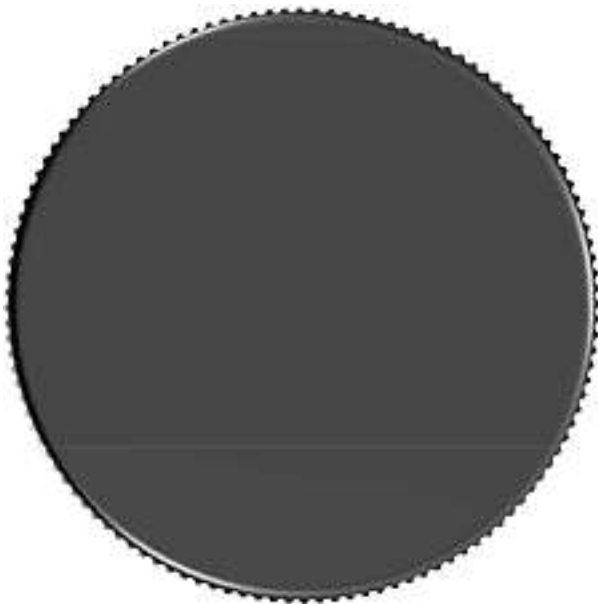





3

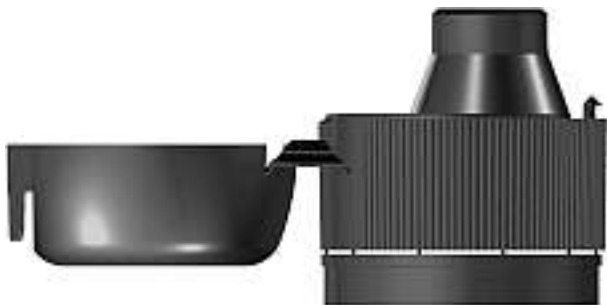







5

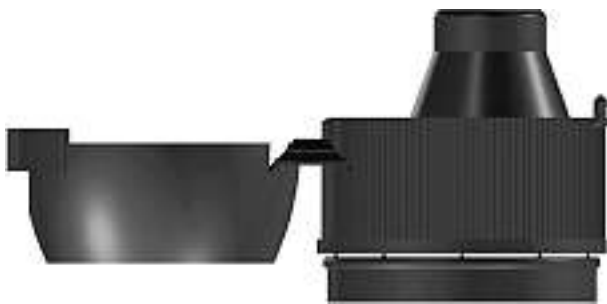



8



9



6



10



7

Cl. 10-07 **132 001** 28.06.2005  
4 design – boîtes de montres, bracelets  
Déposant: Propul's SA, 37-39 Rue Eugène-Marziano,  
1227 Les Acacias  
Designer: Christiane Le Quillec, Les Acacias



CLZ001

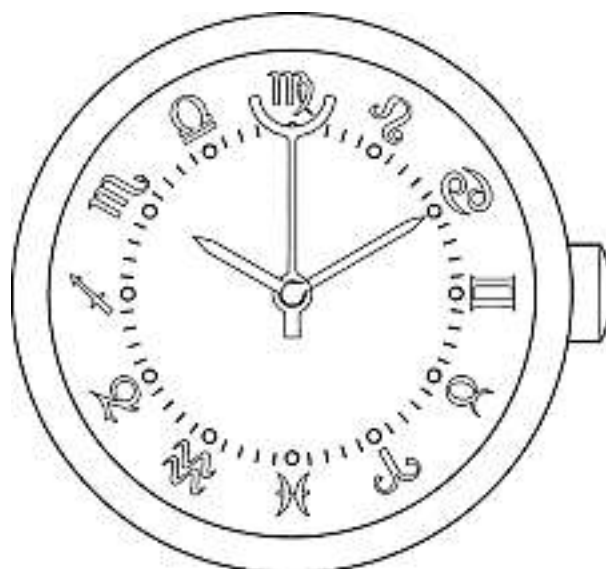

montre horoscope 1



CLZ002



montre horoscope 2



CLD003



CLD004

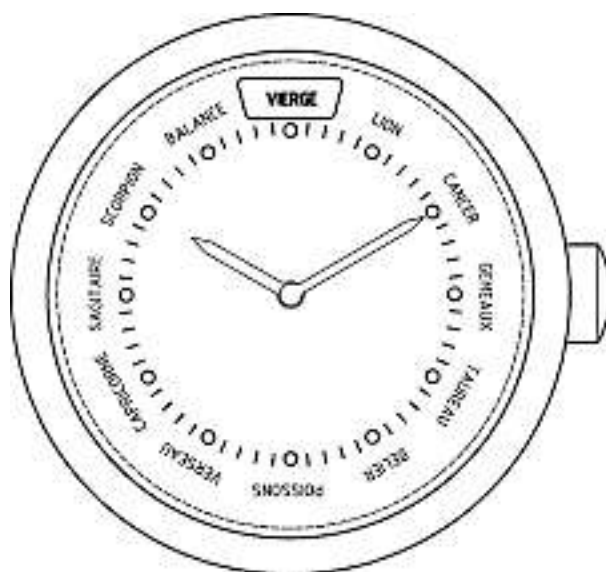

montre horoscope 3

Cl. 10-07 132 002 07.07.2005  
 5 design – cadrans, boîtes de montres  
 Déposant: Montres Choisi S.A., 19, rue du Faucon,  
 Case postale, 2500 Bienne 4  
 Designer: Jean-Pierre Duss, Bienne



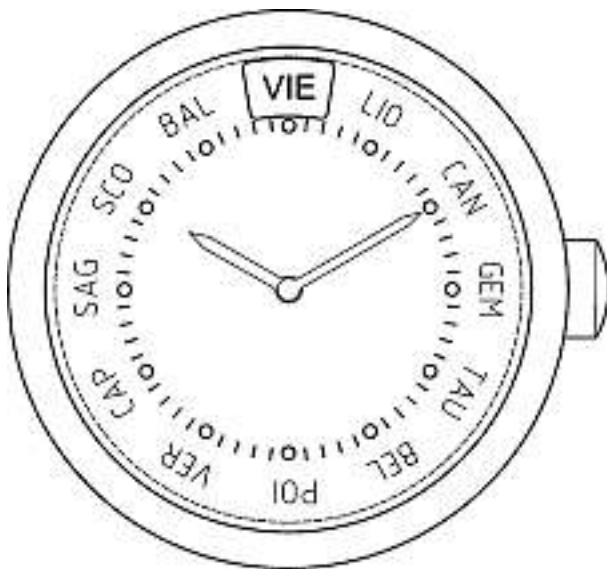

montre horoscope 4

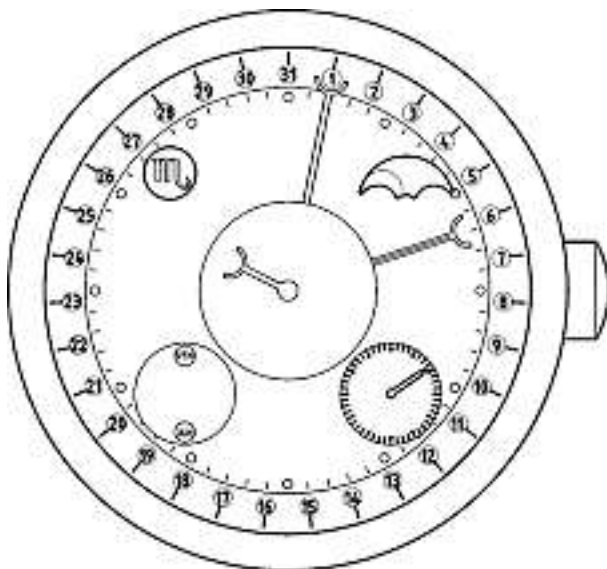

montre horoscope 5

Cl. 10-07                      **132 003**                      07.07.2005  
 2 design – bracelets de montres  
 Déposant: Montres Choisi S.A., 19, rue du Faucon,  
 Case postale, 2500 Bienne 4  
 Designer: Jean-Pierre Duss, Bienne

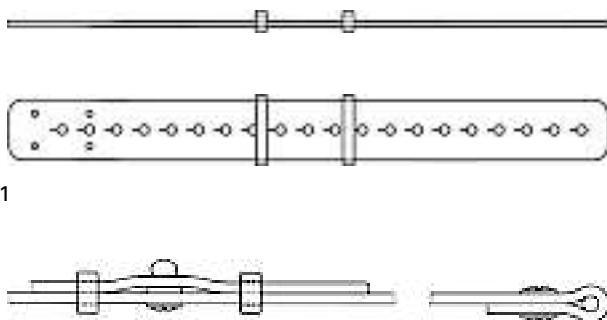

1

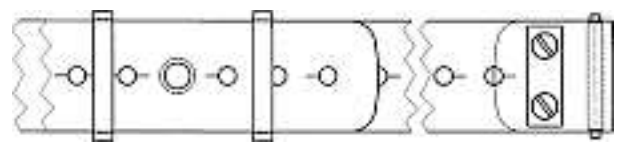

2

Cl. 10-07                      **132 004**                      08.07.2005  
 2 Design – Uhren-Gehäuse  
 Hinterleger: Rolf von Burg, Hofergässli 3, 2544 Bettlach



21668



21755

Cl. 10-07 132 005 14.07.2005  
6 design – boîte de montre, cadran de montre  
Déposant: Seiko Watch Kabushiki Kaisha, (trading as Seiko Watch Corporation), 2-1, Shibaura 1-chome, Minato-ku, Tokyo, JP  
Designer: Tetsuo Okaya, Nagano; Katsunori Kume, Tokyo; Junichi Kamata, Tokyo; Keizo Kumano, Tokyo  
Mandataire: Bovard AG, 3000 Bern 25  
Priorité: JP, 17.01.2005



300492/1



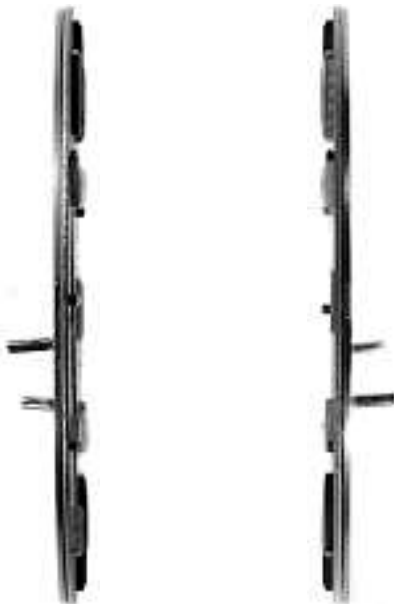

300492/2





300492/3

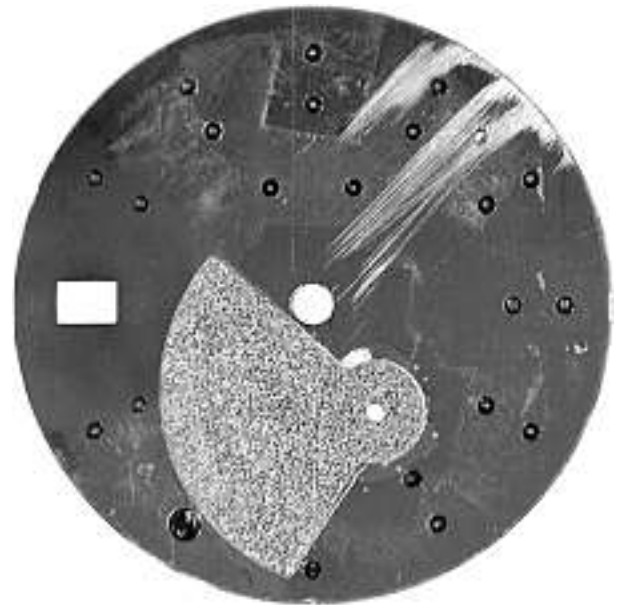



300492/4



300492/5



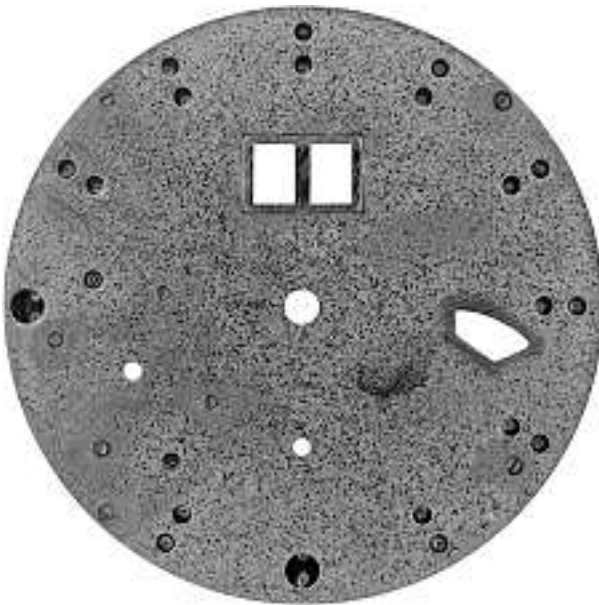
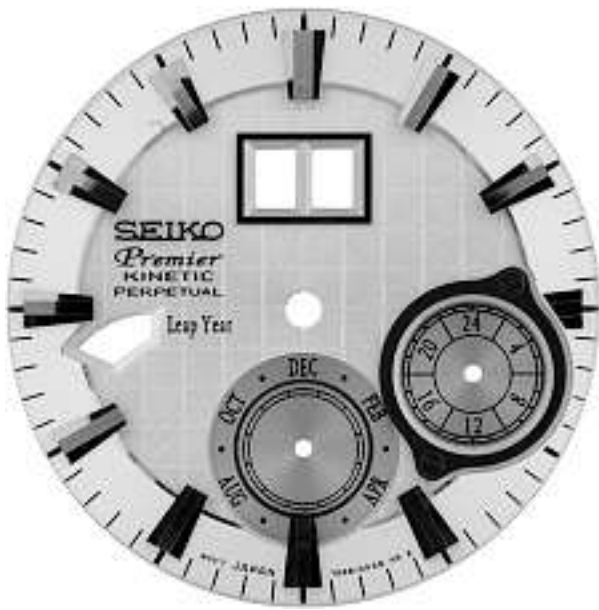

300492/6

Cl. 11-01 132 006 11.07.2005

1 design – bijoux  
 Dépositant: Cartier International B.V., Herengracht 436,  
 Amsterdam, NL  
 Designer: Miyuki Allin, Paris  
 Mandataire: Richemont Intellectual Property Services,  
 1201 Genève  
 Priorité: EM, 03.02.2005

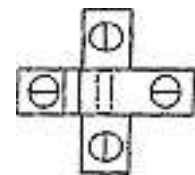
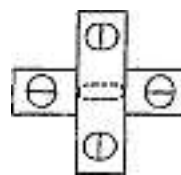
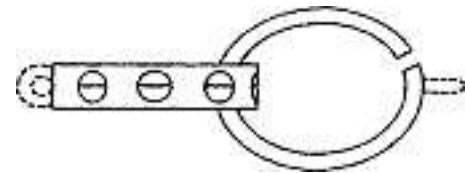
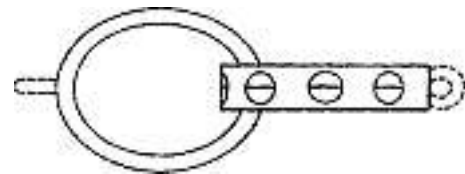
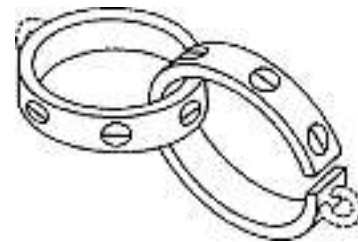

No 719

Cl. 11-02 132 007 06.06.2005

32 Design – Geschenkartikel  
 Hinterleger: Türkoglu GmbH, Nordweg 14, 5037 Muhen  
 Designer: Tuncer Türkoglu, Muhen

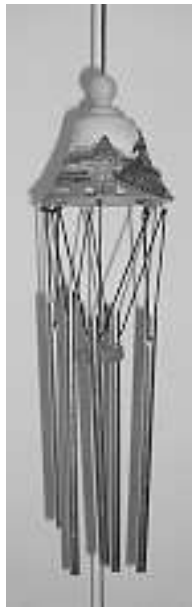

01



02



03

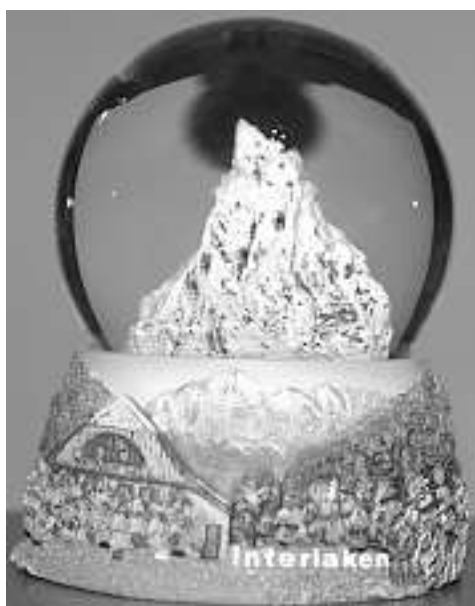

04



05



06



07



08



09



12

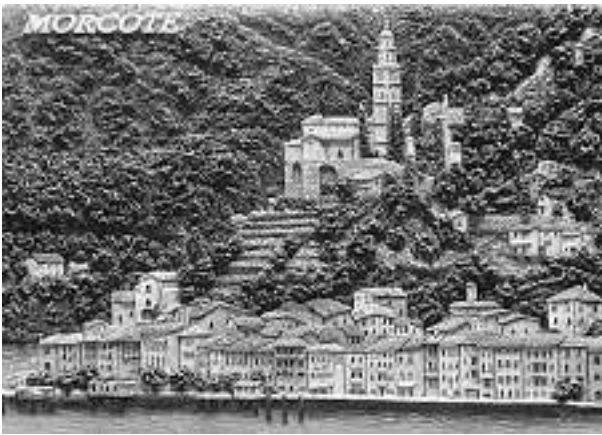

10



13



11



14





15



18



16



19



17



20



21



24



22



25



23



26



27



30



28



31



29



32

Cl. 11-02 132 008 01.07.2005  
 1 Design – Ziergegenstand  
 Hinterleger: Mila GmbH, Andernacher Strasse 31,  
 Nürnberg, DE  
 Designer: Robert Köhler, Nürnberg  
 Vertreter: M.I.L.A. Design- und, Geschenkartikel GesmbH &  
 Co. KG, Wien (A), Zweigniederlassung Wald, 3086 Englisberg



45141

Cl. 12-08 132 009 18.07.2005  
 1 design – automobile  
 Depositante: Honda Motor Co., Ltd., No. 1-1, 2-chome,  
 Minami-aoyama, Minato-ku, Tokyo, JP  
 Designer: Motoaki Minowa, Saitama; Jiro Ikeda, Saitama  
 Mandatario: Fiammenghi-Fiammenghi, 6900 Lugano  
 Priorità: JP, 20.01.2005



454

Cl. 12-08 132 010 18.07.2005  
 1 design – automobile  
 Depositante: Honda Motor Co., Ltd., No. 1-1, 2-chome,  
 Minami-aoyama, Minato-ku, Tokyo, JP  
 Designer: Motoaki Minowa, Saitama; Jiro Ikeda, Saitama  
 Mandatario: Fiammenghi-Fiammenghi, 6900 Lugano  
 Priorità: JP, 20.01.2005





455

Cl. 12-08 132 011 18.07.2005  
 1 design – automobile  
 Depositante: Honda Motor Co., Ltd., No. 1-1, 2-chome,  
 Minami-aoyama, Minato-ku, Tokyo, JP  
 Designer: Manabu Konaka, Saitama  
 Mandatario: Fiammenghi-Fiammenghi, 6900 Lugano  
 Priorità: JP, 20.01.2005



456

Cl. 12-15 132 012 05.07.2005  
1 design – pneumatico per veicolo  
Depositante: Pirelli Pneumatici S.p.A., Viale Sarca 222,  
20126 Milano, IT  
Designer: Alexandre Sorrentino Gerasimczuk, Santo Andre  
Mandatario: Fiammenghi-Fiammenghi, 6900 Lugano  
Priorità: EM, 31.01.2005

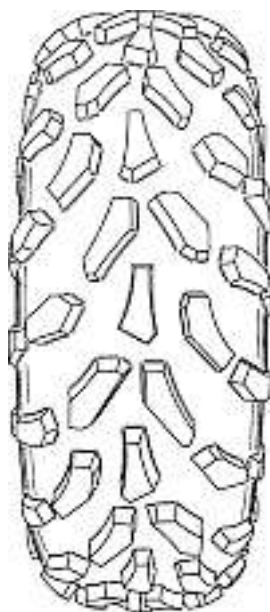
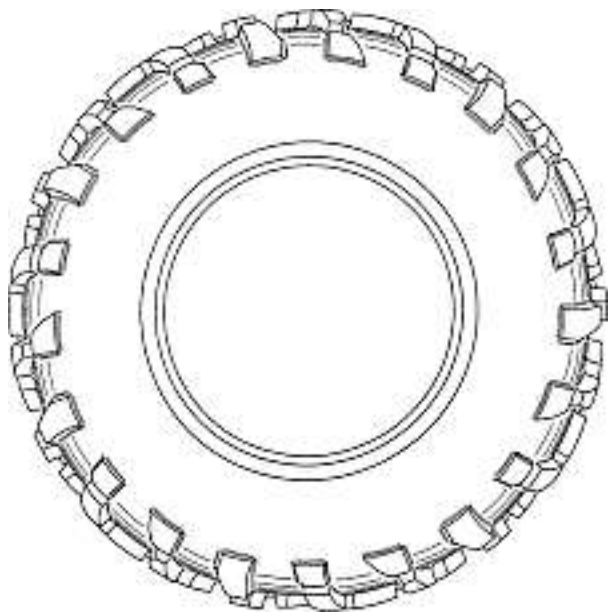
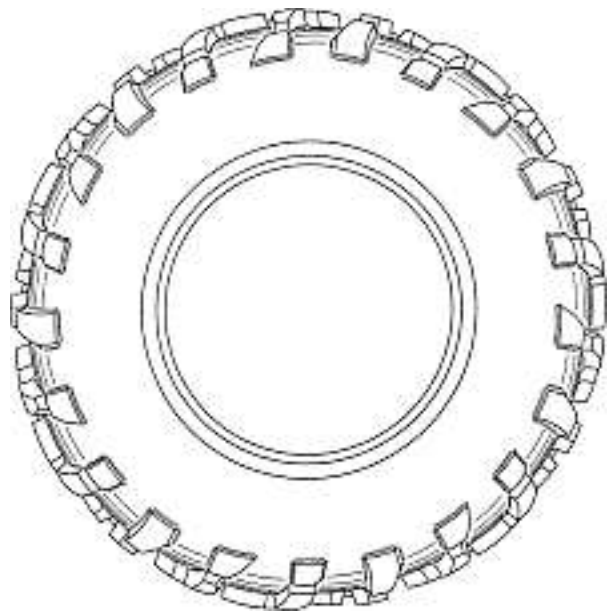

Cl. 12-15 **132 013** 11.07.2005  
 1 Design – Rad für ein Kraftfahrzeug  
 Hinterleger: Kumho Tire Co., Inc., 555, Sochon-Dong,  
 Kwangsan-Gu, Kwangju, KR  
 Designer: Chang Ho Lee, Kwangju; Ha Na Lee, Kwangju  
 Vertreter: Isler & Pedrazzini AG, 8023 Zürich

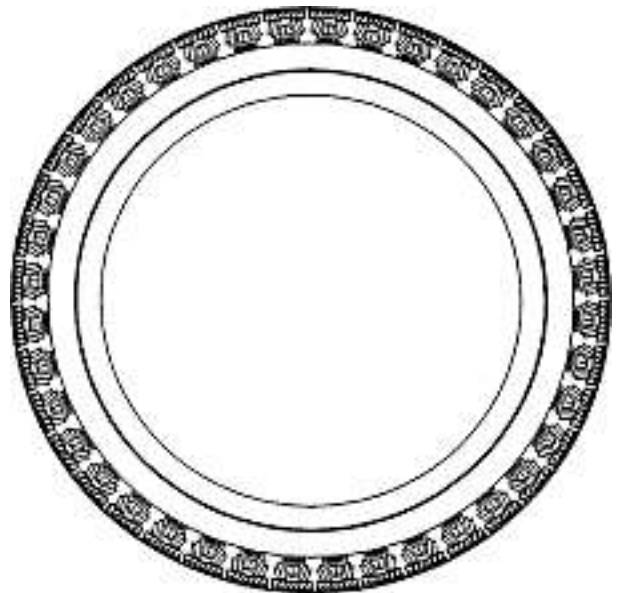
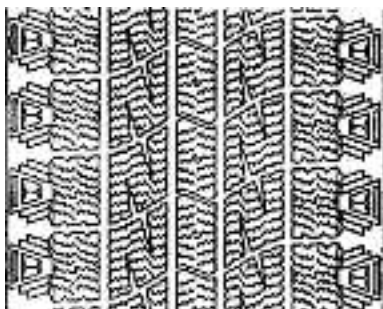
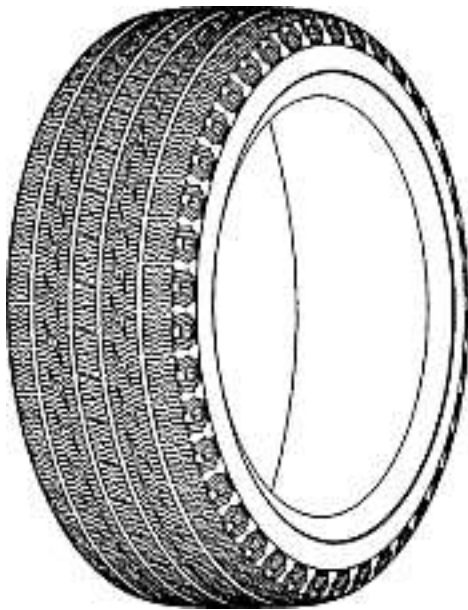

M13045

Cl. 13-03 **132 014** 30.06.2005  
 1 Design – Kabelkanal  
 Hinterleger: Jürg Nigg, Beckenhofstrasse 30, 8035 Zürich



050630

Cl. 19-04 132 015 11.07.2005  
7 Design – Ringordnermechaniken  
Hinterleger: ELBA Buerosysteme GmbH & Co. KG,  
Maybachstrasse 2, Gelsenkirchen, DE  
Designer: Alexander Schlag, Pforzheim; Günter Horntrich,  
Köln  
Vertreter: Troesch Scheidegger Werner AG, Patent- und  
Markenanwälte, 8126 Zumikon  
Priorität: EM, 12.01.2005

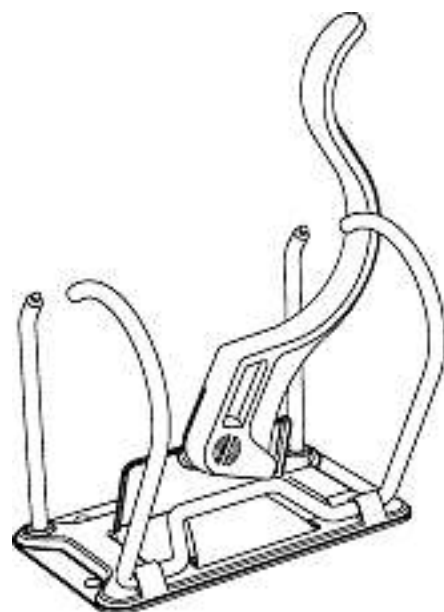



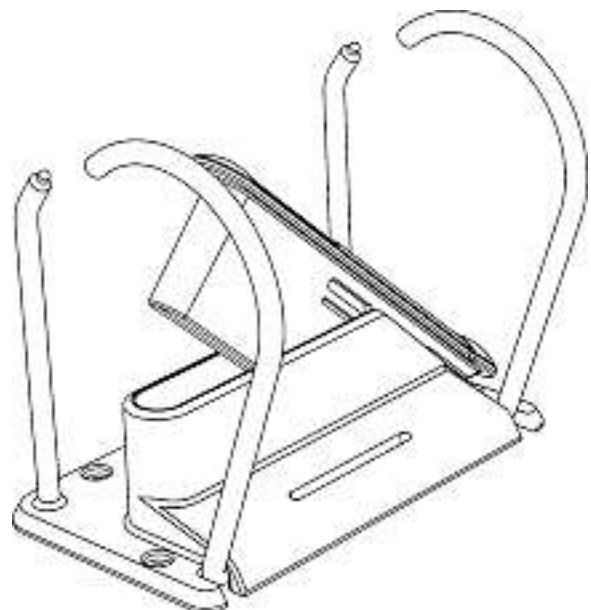
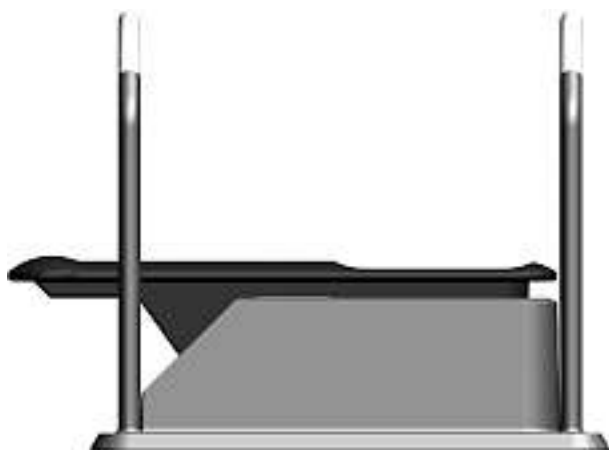
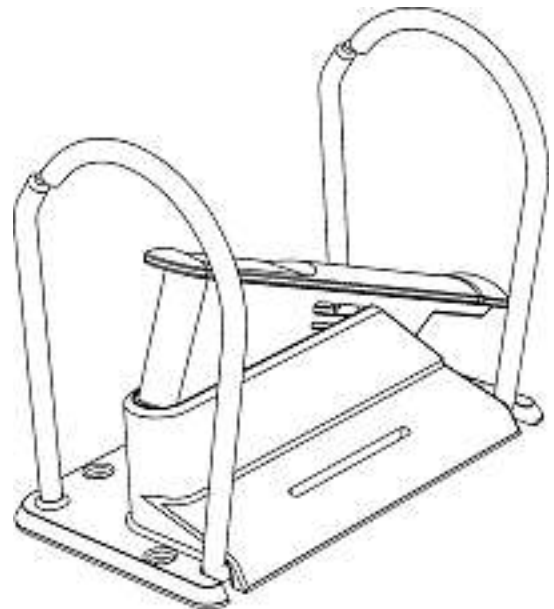



3





4

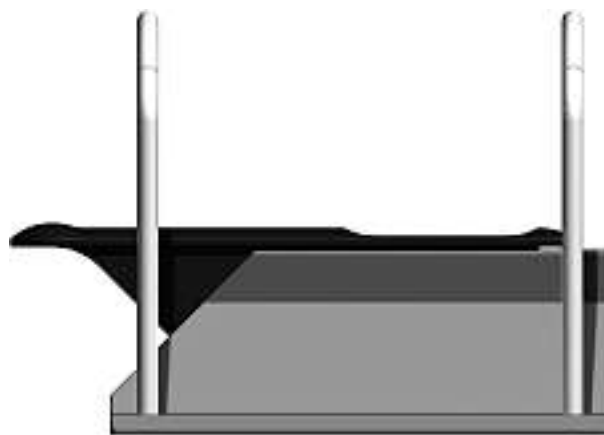

5



6

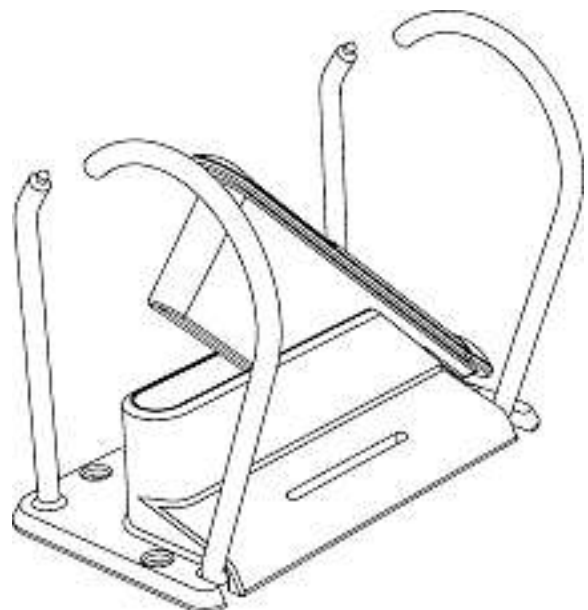
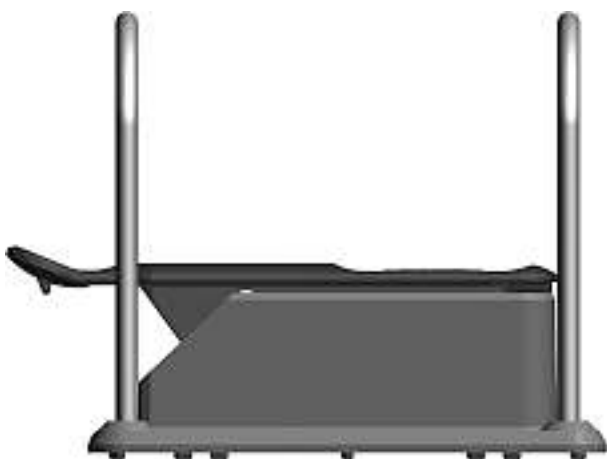
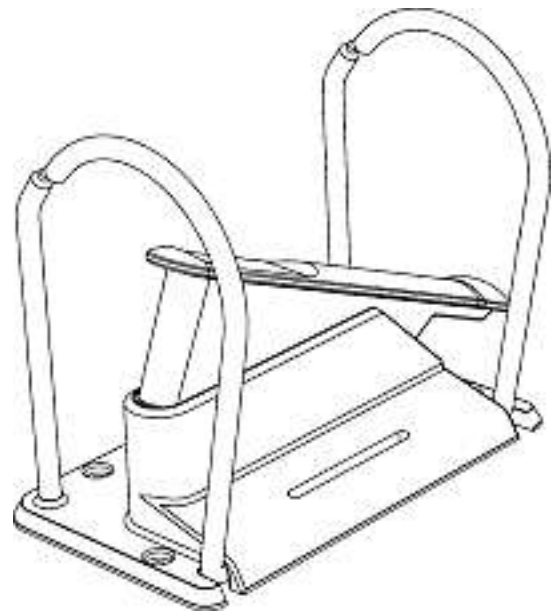

7

Cl. 20-03 132 016 07.07.2005  
 1 Design – Türschild  
 Hinterleger: Rita Weder, Aarburgerstrasse 78, 4600 Olten

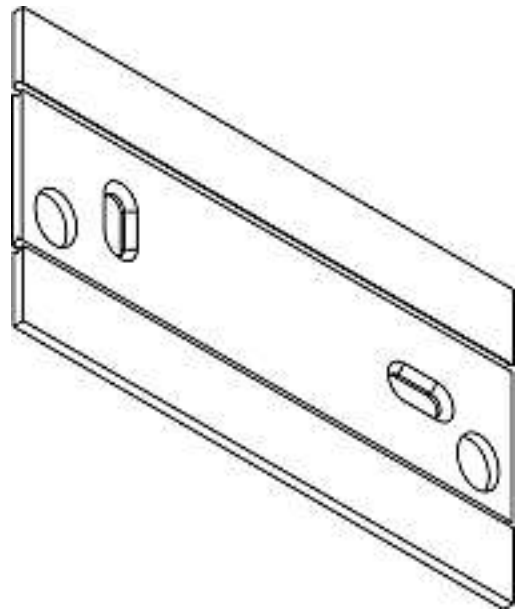
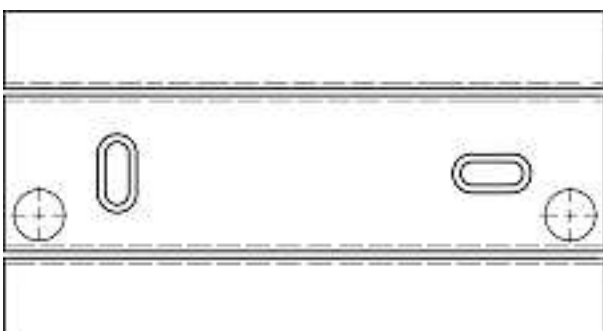

Gertrud W2

Cl. 25-01 132 017 07.07.2005  
 2 Design – Bodenplanken  
 Hinterleger: Werzalit AG + Co. KG, Gronauer Strasse 70,  
 Oberstenfeld, DE  
 Designer: Matthias Schulte, Oberstenfeld  
 Vertreter: A. Braun, Braun, Héritier, Eschmann AG,  
 Patentanwälte, 4051 Basel  
 Priorität: EM, 13.01.2005



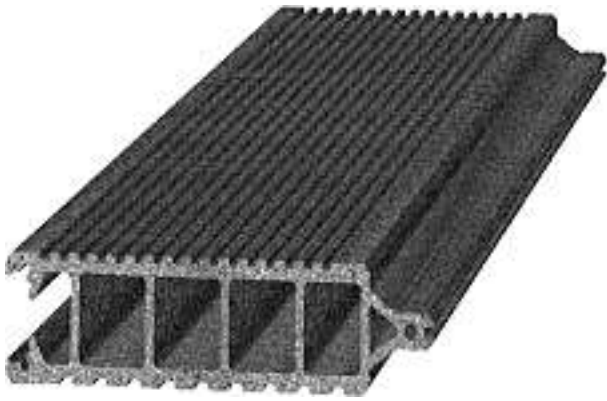

1

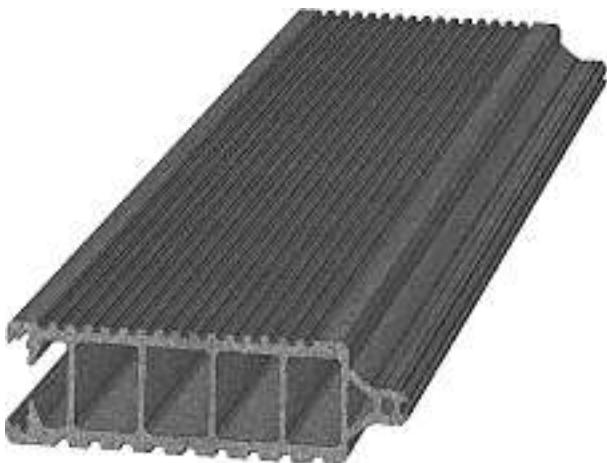
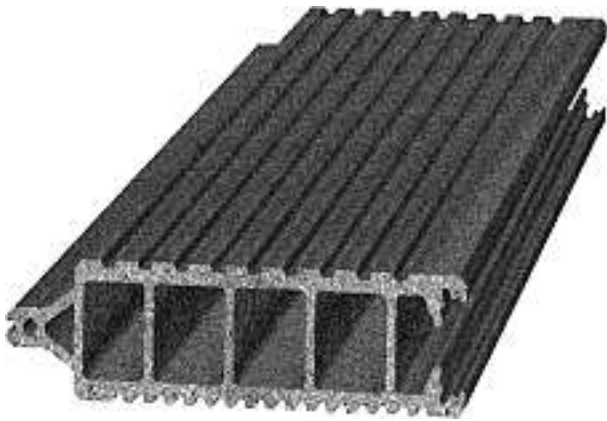

2

Cl. 25-02 132 018 21.06.2005

1 Design – Aufzugstürschwelle

Hinterleger: INVENTIO AG, Seestrasse 55, 6052 Hergiswil NW  
 Designer: Stefano Menchini, Camorino; Guntram Begle,  
 Küssnacht am Rigi

Beschreibung des Designs: Zwischen den beiden Türführungsnuten des Kabinentür-Schwellenprofils ist eine weitere Nut angeordnet. An den Enden dieser Nut befinden sich zylinderförmige Halterungen. An diesen Halterungen angeschlossen ist je eine LED, welche Licht in das Nutinnere emittiert. Durch die rohrförmige Linse in der Nut wird das Licht der LED's gleichmässig verteilt nach oben gestrahlt. Sowohl die Linse als auch die LED's sind durch eine transparente Abdeckung geschützt.

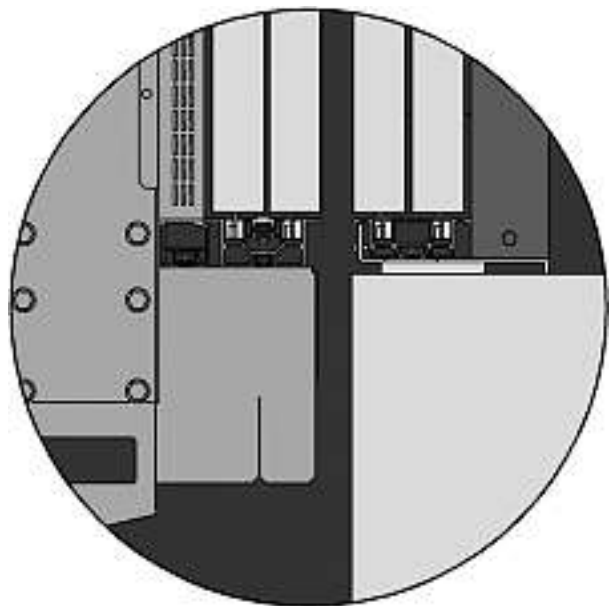
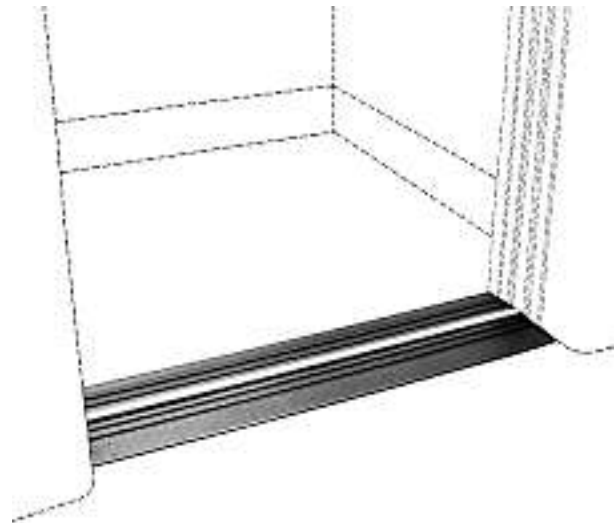

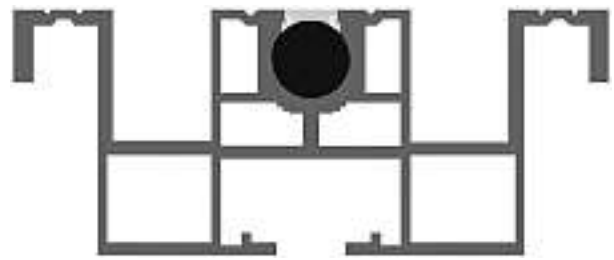
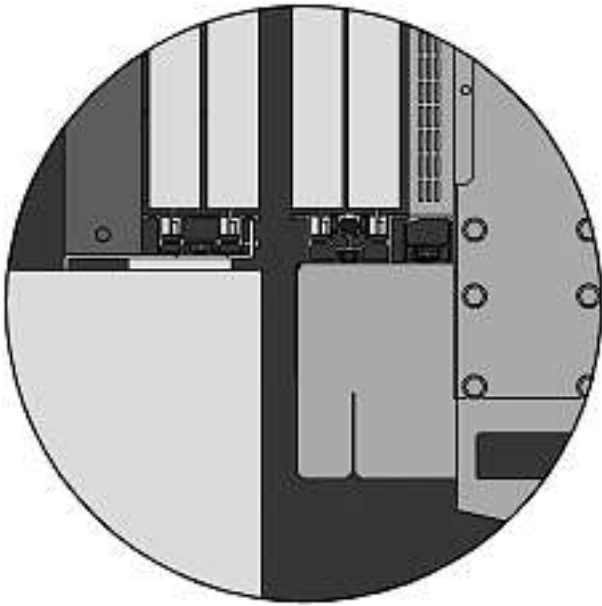

ID32.1CH

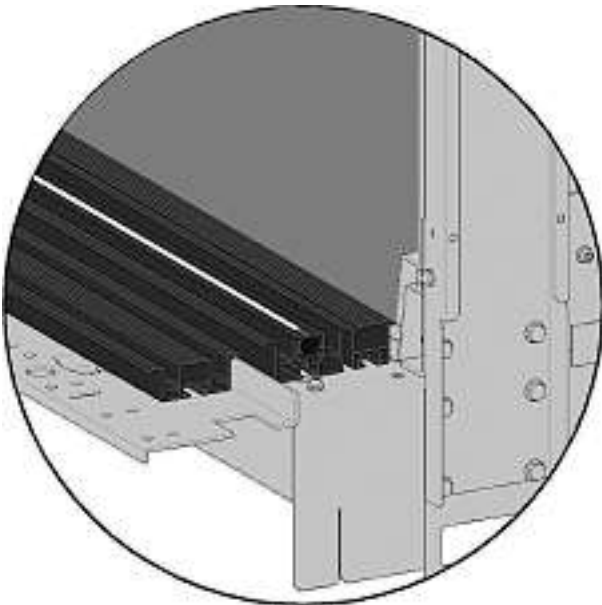

Cl. 25-02 **132 019** 08.07.2005  
2 Design – Fenster-Sichtschutz  
Hinterleger: Emanuel Kägi, Lächlerstrasse 24, 8634  
Hombrechtikon

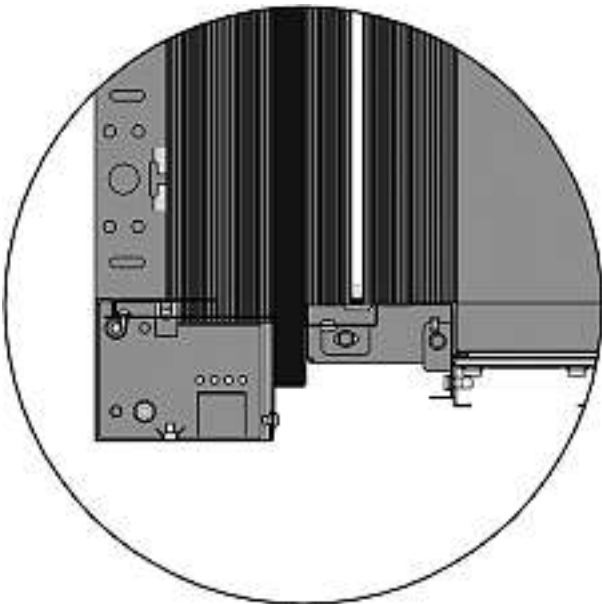

Jade/1

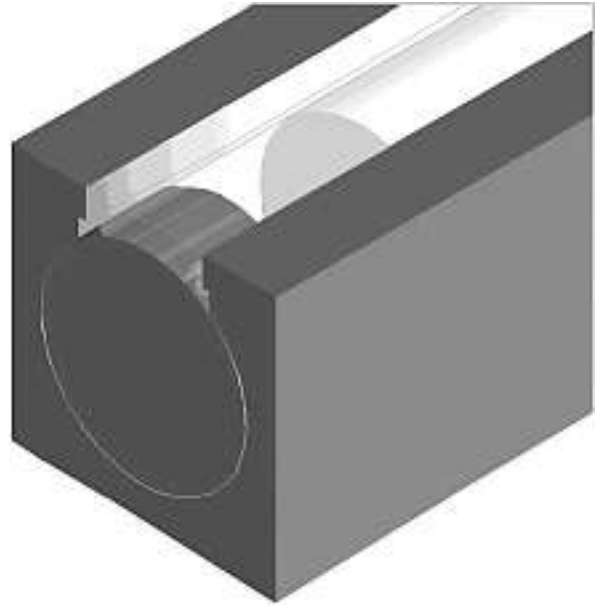

Jade/2

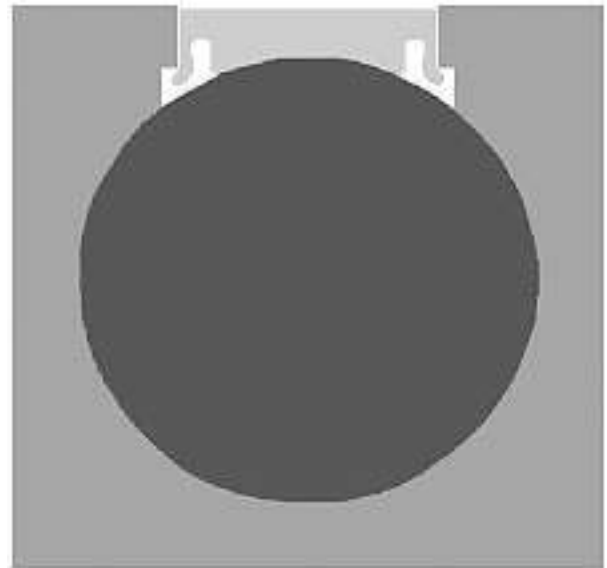

Cl. 26-05                      **132 020**                      21.06.2005  
 1 Design – Lichtmodul mit Träger  
 Hinterleger: INVENTIO AG, Seestrasse 55, 6052 Hergiswil NW  
 Designer: Stefano Menchini, Camorino; Guntram Begle, Küssnacht am Rigi  
 Beschreibung des Designs: An den beiden Kanalenden des Lichtmodul-Trägers befinden sich zylinderförmige Halterungen. An diesen Halterungen angeschlossen ist je eine LED, welche Licht in das Kanalinnere emittiert. Durch die rohrförmige Linse, welche im Kanal des Lichtmodul-Trägers liegt, wird das Licht der LED's gleichmässig verteilt nach oben gestrahlt. Sowohl die Linse als auch die LED's sind durch eine transparente Abdeckung geschützt.

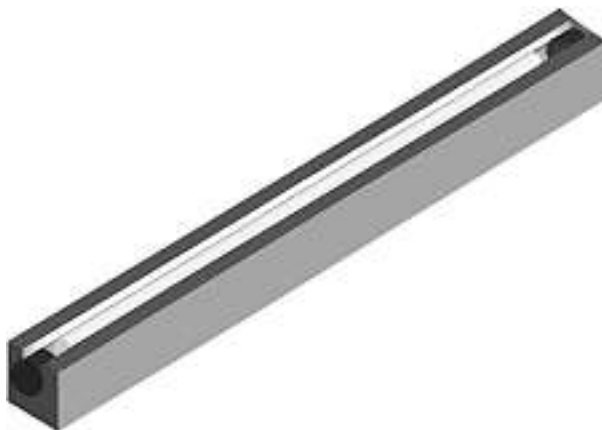



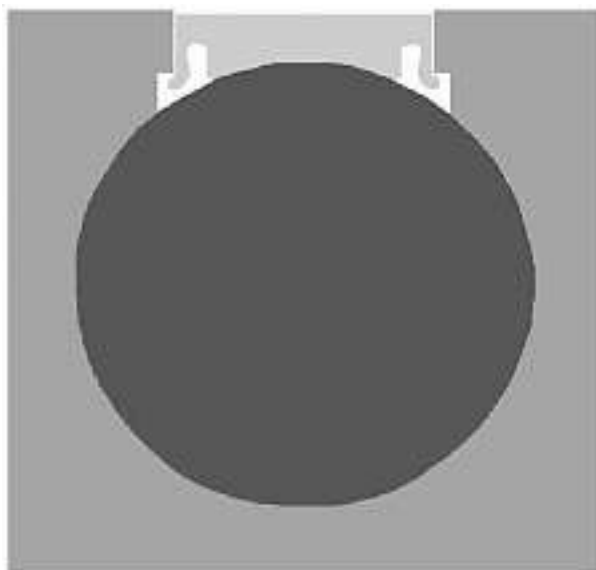

ID32.0CH



Le32 Kaspar 236



Le33 Kaspar 455

Cl. 26-05 **132 022** 30.06.2005  
 2 Design – Leuchtobjekte  
 Hinterleger: Bruno Müller, Ramisbühl 221, 4713 Matzendorf



Cl. 26-05 **132 021** 24.06.2005  
 2 Design – Pendelleuchten  
 Hinterleger: NEUE WERKSTATT GMBH, Oberer Deutweg 1, 8400 Winterthur  
 Designer: Andreas Giupponi, Zürich; Christoph Dietlicher, Zürich; Thomas Drack, Winterthur

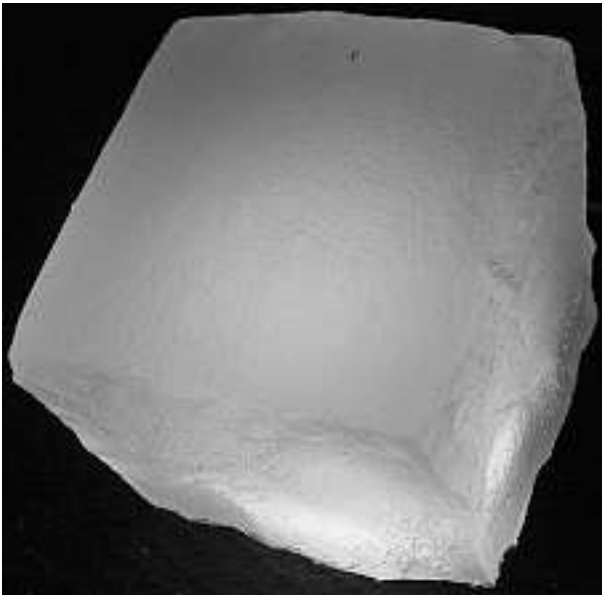

01-05/1



01-05/2

Cl. 26-05 132 023 13.07.2005  
 3 Design – Einbauleuchten  
 Hinterleger: Zumtobel Staff GmbH & Co. KG,  
 Grevenmarschstrasse 74-78, 32657 Lemgo, DE  
 Designer: Chris Redfern, Mailand  
 Vertreter: A. Braun, Braun, Héritier, Eschmann AG,  
 Patentanwälte, 4051 Basel  
 Priorität: EM, 07.02.2005; EM, 07.02.2005; EM, 07.02.2005

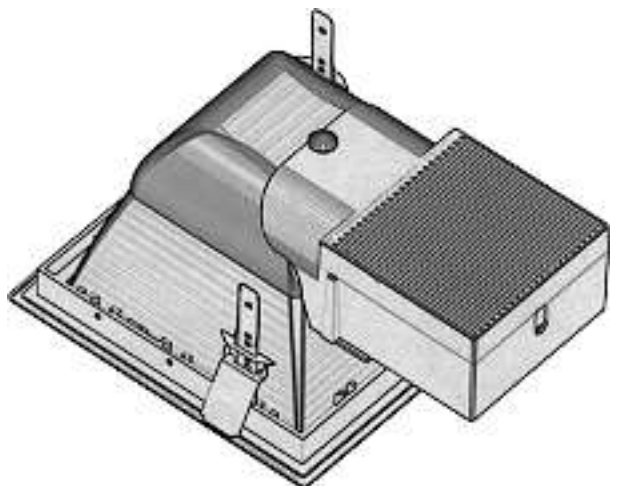
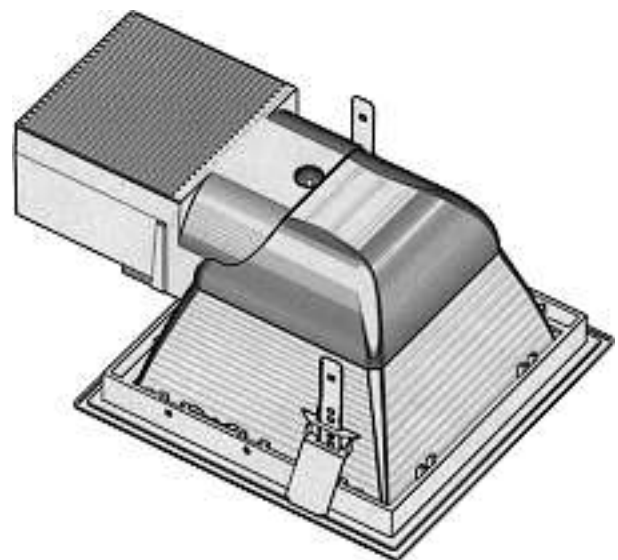
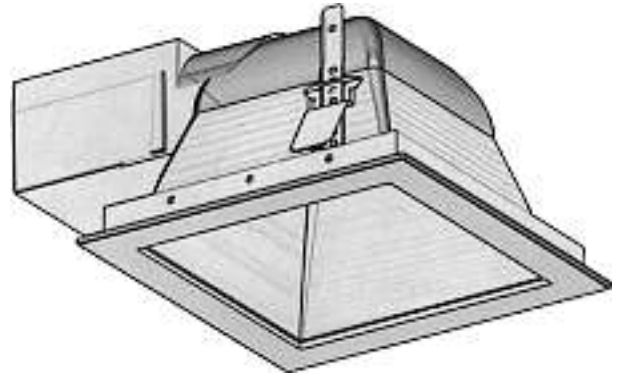

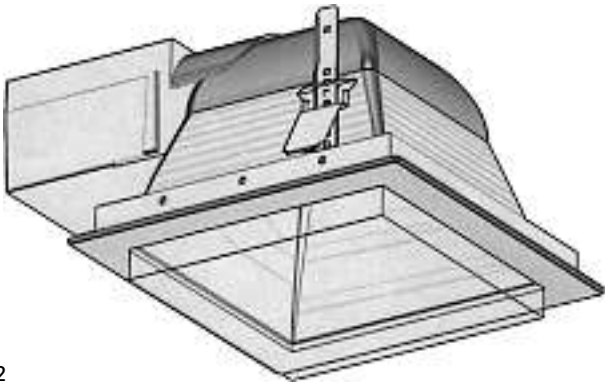

2

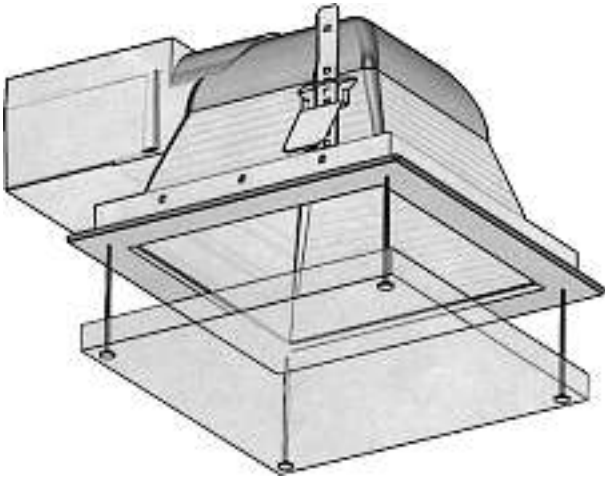

3

Cl. 26-05                      **132 024**                      18.07.2005  
 1 Design – Stehleuchte  
 Hinterleger: Zumtobel Staff GmbH & Co. KG,  
 Grevenmarschstrasse 74-78, 32657 Lemgo, DE  
 Designer: Katharina Goetz-Schaefer, Bad Salzflun  
 Vertreter: A. Braun, Braun, Héritier, Eschmann AG,  
 Patentanwälte, 4051 Basel  
 Priorität: EM, 16.02.2005

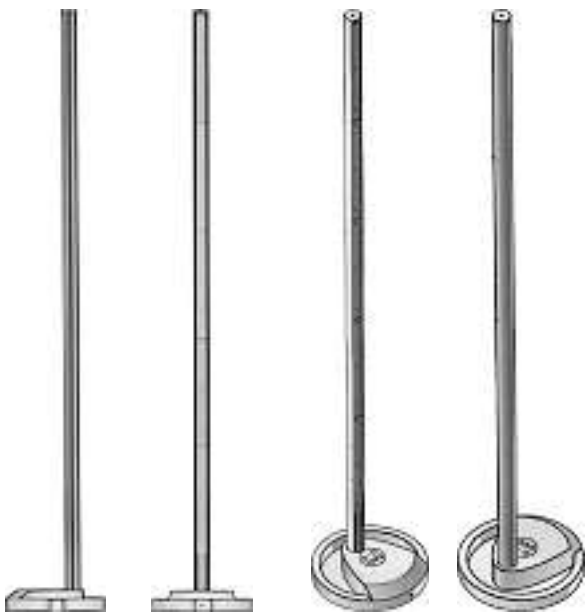

D. 53/2005

Cl. 26-06                      **132 025**                      18.07.2005  
 8 design – gruppi ottici e fanaleria per autoveicolo  
 Depositante: Honda Motor Co., Ltd., No. 1-1, 2-chome,  
 Minami-aoyama, Minato-ku, Tokyo, JP  
 Designer: Jiro Ikeda, Saitama; Yukio Taneoka, Saitama;  
 Tatsuya Oda, Saitama; Jun Nakahara, Saitama  
 Mandatario: Fiammenghi-Fiammenghi, 6900 Lugano  
 Priorità: JP, 19.01.2005; JP, 19.01.2005; JP, 19.01.2005;  
 JP, 19.01.2005; JP, 19.01.2005; JP, 19.01.2005; JP, 19.01.2005;  
 JP, 19.01.2005





453/1

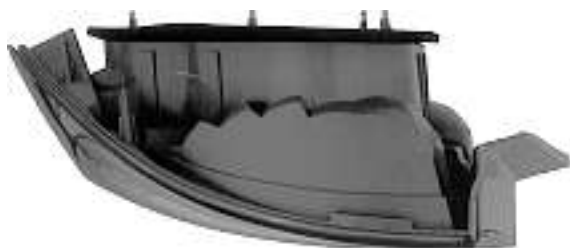

453/2

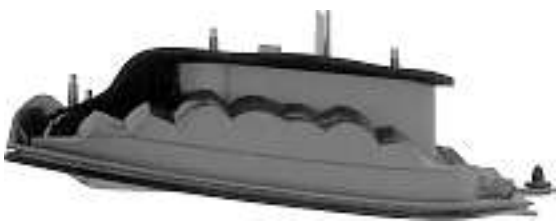
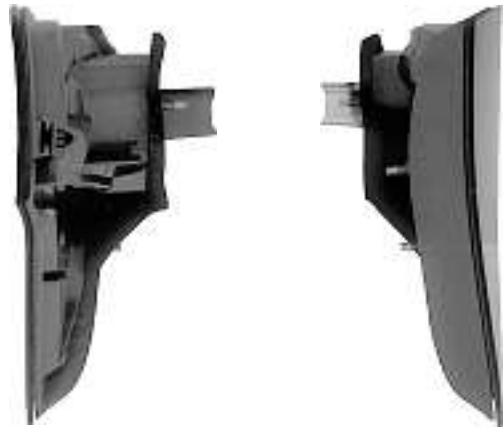

453/3



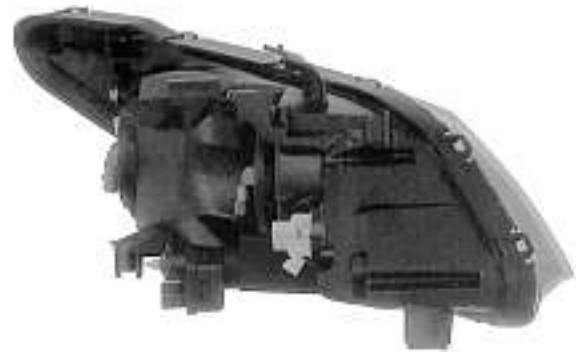

453/4

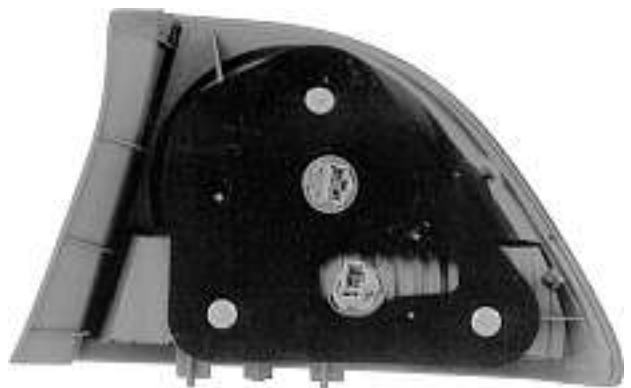



453/5



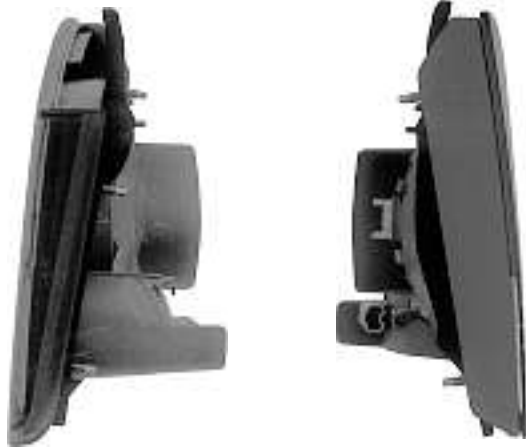





453/7





453/8

Cl. 99-00                      132 026                      01.07.2005  
2 Design – Sarg  
Hinterleger: Andreas Spiegel, Hansaring 77, Köln, DE  
Vertreter: Riederer Hasler & Partner Patentanwälte AG,  
7310 Bad Ragaz  
Priorität: EM, 24.01.2005



1





2

**Verlängerungen  
Prolongations  
Prolongazioni**

118 362 Cl. 09-03 1 Design

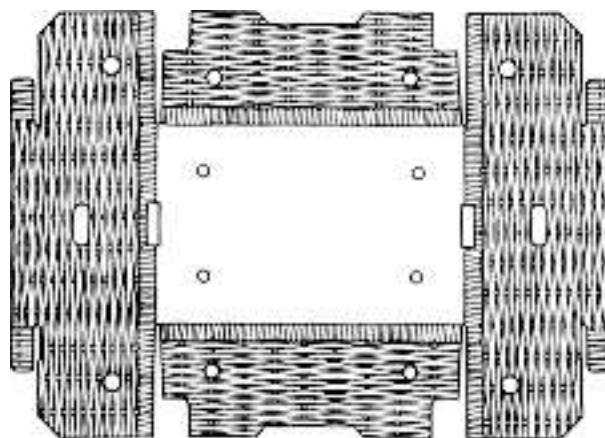

1

118 416 Cl. 04-02 1 design

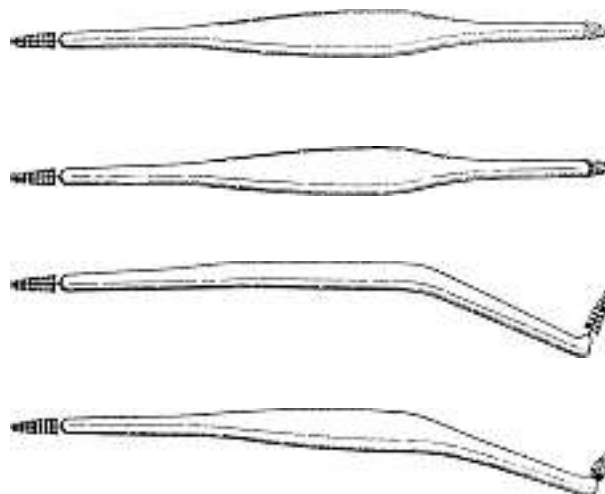

1

- 122 027 Cl. 02-06 2 Design
- 122 559 Cl. 09-03 1 Design
- 122 561 Cl. 10-01 1 Design
- 122 618 Cl. 21-01 8 Design
- 122 673 Cl. 01-01 1 design
- 122 702 Cl. 10-02 1 Design
- 122 712 Cl. 21-04 2 Design
- 122 904 Cl. 26-04 1 Design
- 122 910 Cl. 04-02 3 Design
- 127 214 Cl. 07-01 2 Design
- 127 227 Cl. 16-99 1 Design
- 127 273 Cl. 28-03 2 Design
- 127 276 Cl. 03-01 1 design
- 127 306 Cl. 21-03 3 Design
- 127 310 Cl. 25-01 8 Design
- 127 330 Cl. 06-99 24 Design
- 127 382 Cl. 14-01 1 design
- 127 401 Cl. 25-01 1 Design
- 127 458 Cl. 06-04 1 Design
- 127 464 Cl. 10-05 2 Design
- 127 480 Cl. 24-02 8 Design
- 127 491 Cl. 03-01 2 Design
- 127 532 Cl. 06-03 8 Design
- 127 549 Cl. 11-02 1 Design

127 550	Cl.	11-02	1 Design
127 588	Cl.	09-01	1 Design
127 597	Cl.	19-02	1 Design
127 723	Cl.	19-06	3 design
127 724	Cl.	19-06	2 design

126 744	Cl.	26-05	1 Design
126 757	Cl.	07-01	1 Design
126 763	Cl.	09-03	2 design
126 782	Cl.	24-01	1 Design
126 819	Cl.	19-08	1 Design
126 820	Cl.	19-08	1 Design
126 910	Cl.	23-04	1 design
126 911	Cl.	23-04	1 design
126 953	Cl.	21-01	1 Design

## Mutationen Modifications Modificazioni

### 122 600

Namensänderung  
Hinterleger: Etter Söhne AG, Chollerstrasse 4, 6300 Zug

### 122 673

Changement du nom  
Déposant: Françoise Revelly-Bugnon, Rue de la Berra 52,  
1630 Bulle

### 127 169

Namensänderung  
Hinterleger: Kummler + Matter AG, Oltnerstrasse 63,  
5013 Niedergösgen

### 130 313

Übertragung  
Hinterleger: Swisray International, Inc.,  
1180 McLester Street,  
Unit #2, Elizabeth, NJ 07201, US  
Vertreter: Hepp Wenger Ryffel AG, 9500 Wil SG

### 131 494

Übertragung  
Hinterleger: SWISSDONUTS GMBH, Schmidstrasse 9,  
8570 Weinfelden  
Vertreter: Isler & Pedrazzini AG, 8023 Zürich

## Löschungen Radiations Radiazioni

117 964	Cl.	08-08	2 Design
117 971	Cl.	10-07	19 Design
117 983	Cl.	20-02	1 Design
118 037	Cl.	10-02	1 Design
122 053	Cl.	10-02	2 design
122 054	Cl.	10-02	20 Design
122 055	Cl.	10-02	1 design
122 056	Cl.	10-07	2 design
122 058	Cl.	14-01	1 Design
122 060	Cl.	18-04	30 Design
122 068	Cl.	23-02	2 Design
122 071	Cl.	26-05	1 Design
122 086	Cl.	09-05	9 Design
122 092	Cl.	12-11	1 Design
122 143	Cl.	26-02	2 design
122 235	Cl.	19-07	2 Design
126 683	Cl.	09-05	2 Design
126 699	Cl.	26-05	1 Design
126 701	Cl.	02-04	1 Design
126 703	Cl.	06-01	5 Design
126 704	Cl.	06-01	1 Design
126 705	Cl.	06-01	1 Design
126 708	Cl.	06-03	2 Design
126 712	Cl.	06-06	1 Design
126 713	Cl.	06-11	1 Design
126 718	Cl.	08-05	1 Design
126 722	Cl.	10-02	1 design
126 730	Cl.	14-02	1 Design
126 733	Cl.	14-03	1 design
126 737	Cl.	19-03	1 Design
126 738	Cl.	19-08	1 Design
126 739	Cl.	20-03	1 design
126 742	Cl.	21-02	3 Design
126 743	Cl.	26-01	1 Design