

Nationale Hinterlegungen

In der folgenden Liste werden die beim Eidgenössischen Institut für Geistiges Eigentum hinterlegten Designs publiziert. Dabei sind der Reihe nach angegeben:

- internationale Klassenangaben
- Hinterlegungsnummer
- Hinterlegungsdatum
- Allenfalls Aufschub der Veröffentlichung
- Anzahl der hinterlegten Designs
- Bezeichnung
- Name und Wohnsitz des Hinterlegers oder der Hinterlegerin
- gegebenenfalls Name und Wohnsitz des Designers oder der Designerin
- Name und Geschäftssitz des allfälligen Vertreters oder der Vertreterin
- gegebenenfalls Prioritätsangaben
- gegebenenfalls Beschreibungstext
- Ordnungsnummer
- Reproduktion des Designs

Internationale Hinterlegungen

Die bei der Weltorganisation für geistiges Eigentum in Genf hinterlegten Muster und Modelle mit Benennung Schweiz geniessen den gleichen Schutz wie national hinterlegte Designs. Sie werden jeweils im Blatt «Bulletin des dessins et modèles internationaux» veröffentlicht. Dieses Publikationsorgan ist deshalb für eine vollständige Recherche unbedingt beizuziehen.

Topographien

Angaben über die vom Eidgenössischen Institut für Geistiges Eigentum eingetragenen Topographien von Halbleitererzeugnissen werden in folgender Anordnung aufgeführt:

- Eintragungsnummer
- Anmeldedatum
- Bezeichnung
- Name und Wohnsitz des Anmelders oder der Anmelderin
- gegebenenfalls Name und Wohnsitz des Herstellers oder der Herstellerin
- Name und Geschäftssitz des oder der allfälligen Bevollmächtigten
- Datum und Ort einer allfälligen ersten geschäftlichen Verbreitung der Topographie

Dépôts nationaux

Les designs déposés à l'Institut Fédéral de la Propriété Intellectuelle sont publiés dans la liste qui suit. Les indications y relatives sont mentionnées dans cet ordre:

- indications des classes internationales
- numéro de dépôt
- date de dépôt
- le cas échéant, ajournement de la publication
- nombre des designs déposés
- désignation
- nom et domicile du/de la déposant/e
- le cas échéant, nom et domicile du/de la designer
- nom et domicile de l'éventuel/le mandataire
- le cas échéant, indication de priorité
- le cas échéant, description du design
- numéro attribué à chaque design
- reproduction du design

Dépôts internationaux

Les dessins et modèles déposés à l'Organisation Mondiale de la Propriété Intellectuelle à Genève qui désignent la Suisse jouissent de la même protection que les dépôts nationaux. Ils sont chaque fois publiés dans la feuille «Bulletin des dessins et modèles internationaux». Pour une recherche complète, il est indispensable de consulter ledit organe de publication.

Topographies

Les indications concernant les topographies des produits semi-conducteurs, enregistrées par l'Institut Fédéral de la Propriété Intellectuelle, sont énumérées dans l'ordre suivant:

- numéro d'enregistrement
- date de dépôt
- désignation
- nom et domicile du/de la déposant/e
- le cas échéant, nom et domicile du/de la producteur/trice
- nom et domicile de l'éventuel/le mandataire
- date et lieu d'une éventuelle première mise en circulation de la topographie

Depositi nazionali

Nella lista seguente vengono pubblicati i design depositati presso l'Istituto Federale della Proprietà Intellettuale. Sono menzionati nel seguente ordine:

- indicazioni delle classi internazionali
- numero di deposito
- data del deposito
- se del caso, indicazione che la pubblicazione è stata differita
- numero dei design depositati
- designazione
- nome e domicilio del depositante
- se del caso, nome e domicilio del designer
- nome e sede di un eventuale mandataro
- se del caso, indicazioni di priorità
- se del caso, descrizione del design
- numero d'ordine
- riproduzione del design

Depositi internazionali

I disegni e modelli depositati presso l'Organizzazione Mondiale della Proprietà Intellettuale a Ginevra con denominazione Svizzera godono della medesima protezione del deposito nazionale. Essi vengono pubblicati ogni volta nel foglio «Bulletin des dessins et modèles internationaux». Quest'organo di pubblicazione è da consultare se si vuole effettuare una ricerca completa.

Topografie

Le indicazioni concernenti le topografie di prodotti a semiconduttori depositati presso l'Istituto Federale della Proprietà Intellettuale sono menzionate nell'ordine seguente:

- numero di registrazione
- data del deposito
- designazione
- nome e domicilio del/la richiedente
- se del caso, nome e domicilio del/la produttore/trice
- nome e sede di un eventuale mandataro
- data e luogo di un'eventuale prima messa in circolazione della topografia

**Hinterlegungen
Dépôts
Deposit**

Cl. 23-03 **130 113** 28.10.2003
1 Design – Ofen
André Riemens, Gartenstrasse 4, 8902 Urdorf und
Gabriela Vetsch, Gartenstrasse 4, 8902 Urdorf.
Vertr.: André Riemens, Urdorf
Aufgeschobene Publikation

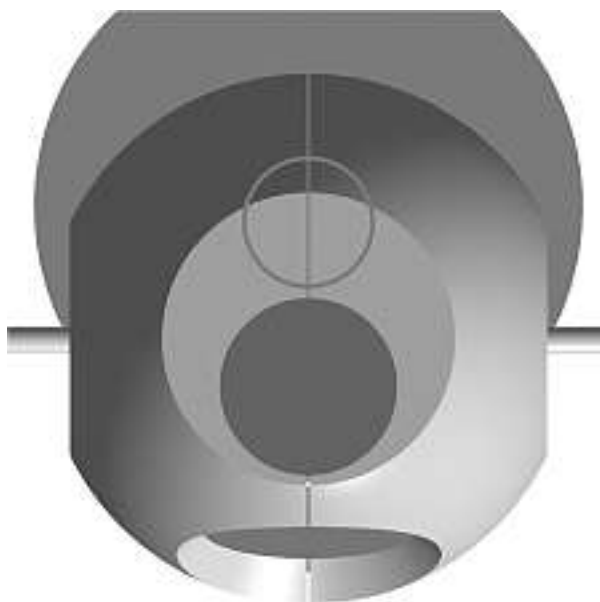
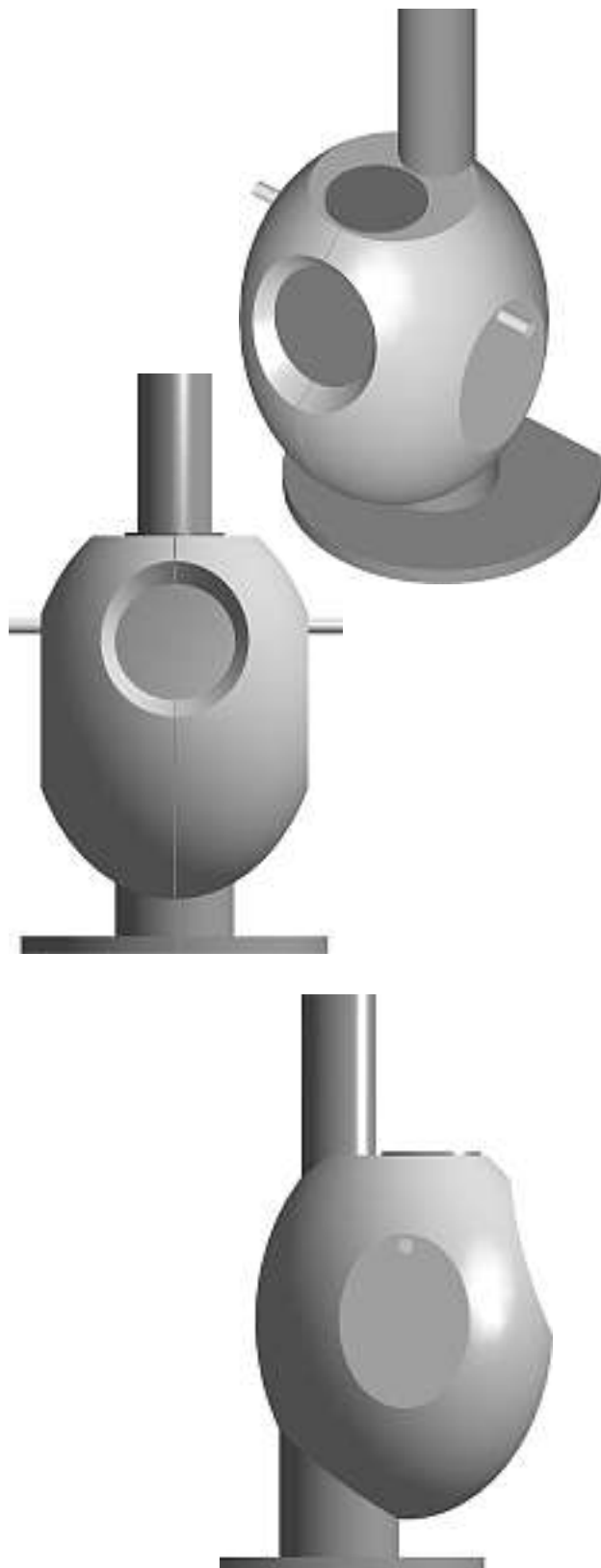

2050

Cl. 2-02 **130 326** 12.01.2004
1 Design – Poncho
Sabrina Sigg, Innere Meriweg, 3718 Kandersteg





mapeau



3505-CH-2-DESIGN

Cl. 2-06 130 327 28.11.2003
 1 Design – Sporthandschuh
 Reusch International Licence GmbH & Co. KG, Metzinger
 Strasse 75, Metzingen (DE). Rechtsnachfolgerin des
 Designers Jürg Buchmeier, Valencia.
 Vertr.: Mattli Hew Meisser Weinmann, Davos Platz



Cl. 3-01 130 328 05.12.2003
 1 Design – Tasche
 Priska Fels, Oelestrasse 16, 3800 Matten b. Interlaken



pfefferland

Cl. 3-01 130 329 16.12.2003
 3 Designs – Tasche, Necessaire, Etui
 Irene Sulser, Seestrasse 213, 8802 Kilchberg ZH



Einkaufstasche



Stadtplan-Necessaire



Stadtplan-Etui

Cl. 3-01 130 330 17.12.2003
 1 Design – Schlüsselanhänger
 Aurema SA, Jurastrasse 74, 2540 Grenchen. Rechtsnachfolgerin der Designerin Ursula von Burg, Grenchen



Rubber-Crystal-Keyholder-1217

Cl. 3-01 130 331 19.12.2003
 1 Design – Beutel
 Stokke Gruppen AS, Hahjem, Skodje (NO). Rechtsnachfolgerin der Designerin Hilde Angelfoss Oxseth, Alesund.
 Vertr.: Frei Patentanwaltsbüro, Zürich
 Prior.: Norwegen 03.07.2003





D0092CH

Cl. 3-01 130 332 22.01.2004
 3 Designs – Taschen
 TUI AG, Karl-Wiechert-Allee 4, Hannover (DE). Rechtsnachfolgerin des Designers Guido Maria Kretschmer, Münster.
 Vertr.: Hans Rudolf Gachnang, Frauenfeld
 Prior.: EM 23.07.2003



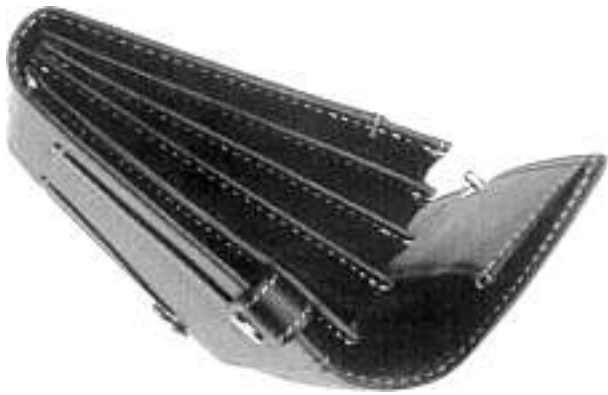

1

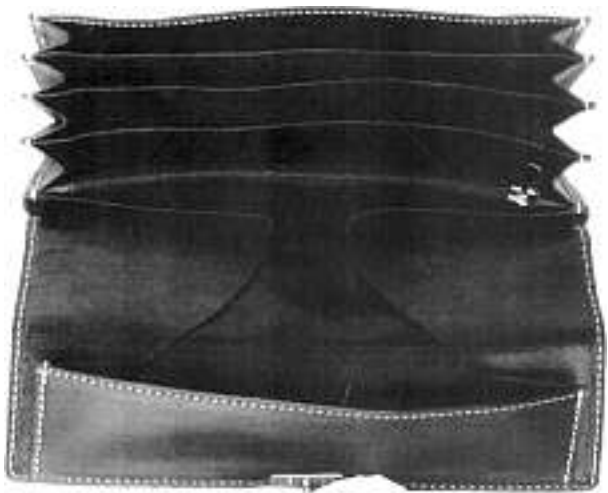





Cl. 4-02 130 333 13.02.2004
1 Design – Zahnbürste
GlaxoSmithKline Consumer Healthcare GmbH & Co. KG,
Bussmatten 1, Bühl (DE). Rechtsnachfolgerin des
Designers Matthias Georgi, Buehl.
Vertr.: Isler & Pedrazzini AG, Zürich
Prior.: Grossbritannien 15.08.2003

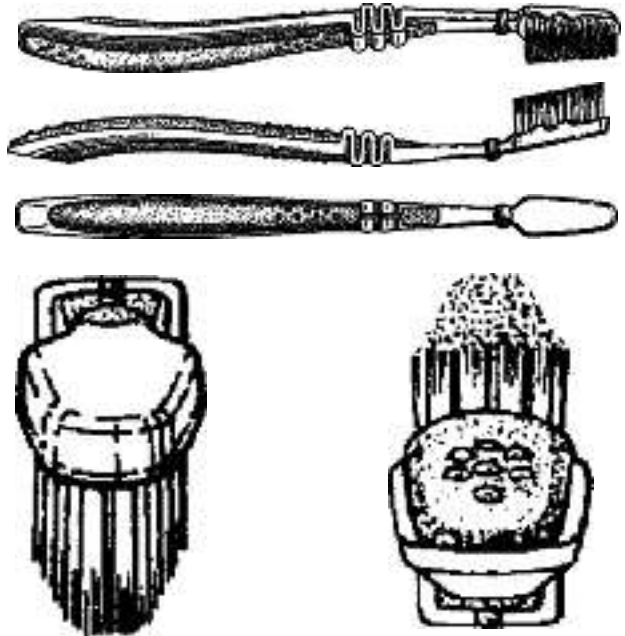

M12881

Cl. 4-02 130 334 18.02.2004
1 Design – Bürste
Wen-D Enterprises LLC, P.O. Box 771847, Steamboat
Springs/CO (US). Rechtsnachfolgerin des Designers
David Puckett, Haden.
Vertr.: E. Blum & Co., Zürich
Prior.: USA 18.08.2003

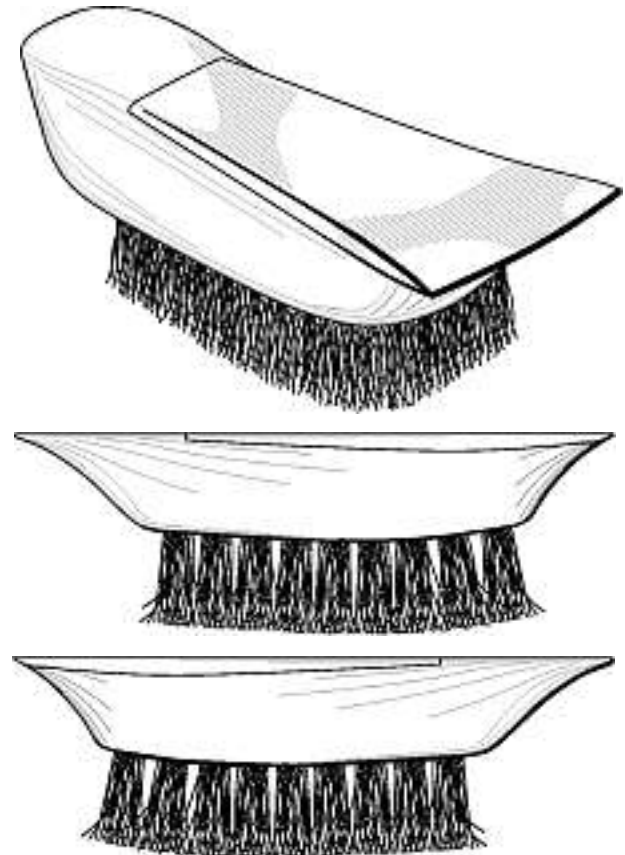

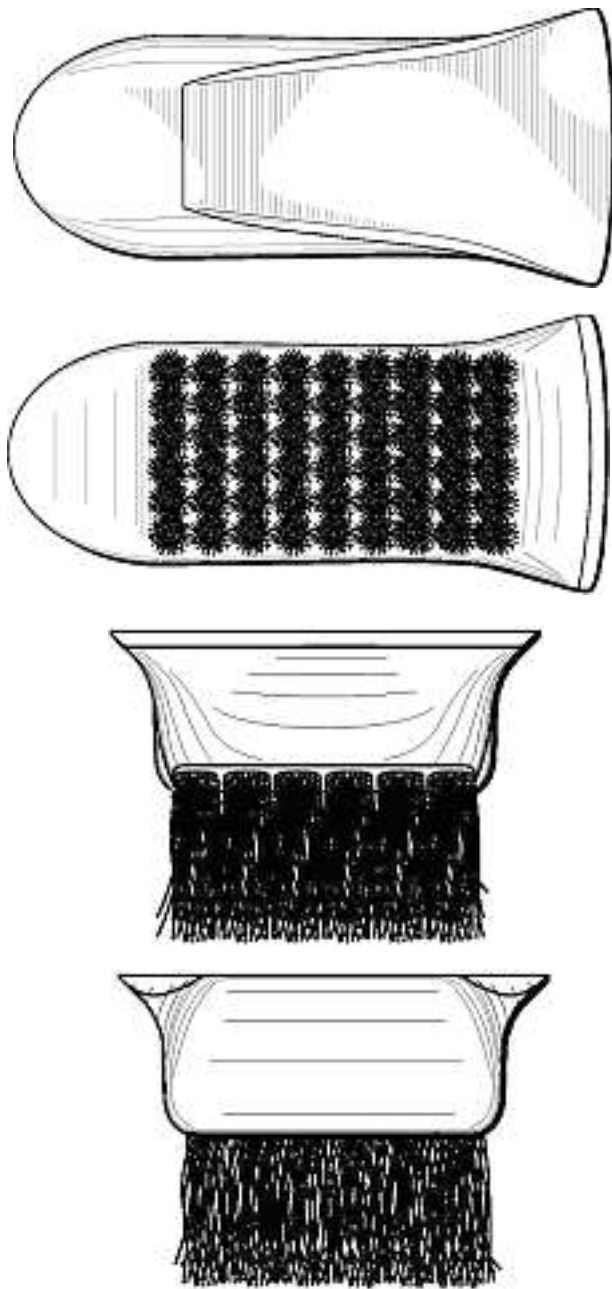

A-2004/1007



D0091CH-1

Cl. 6-01 130 335 19.12.2003
 2 Designs – Kindersitz
 Stokke Gruppen AS, Hahjem, Skodje (NO). Rechtsnachfolgerin der Designerin Hilde Angelfoss Oxseth, Alesund.
 Vertr.: Frei Patentanwaltsbüro, Zürich
 Prior.: Norwegen 03.07.2003





D0091CH-2

Cl. 6-01 **130 336** 05.01.2004
2 Designs – Sessel, Eckessel
Andreas Brinkmann, Auenwiesenstrasse 7, 8363 Bichelsee



Wings 1





Wings 2

Cl. 6-01 **130 338** 14.01.2004
 1 Design – Polstermöbel
 Intertime AG, Polstermöbelfabrik, Brühlstrasse 21,
 5304 Endingen. Rechtsnachfolgerin des Designers
 Johannes Weibel, Untersiggenthal



2470

Cl. 6-01 **130 337** 07.01.2004
 2 Designs – Liege
 Fabian Schwaerzler, Hondrichstrasse 40, 3700 Spiez



romancouch1



romancouch2

Cl. 6-01 **130 339** 14.01.2004
 2 Designs – Polstermöbel
 Intertime AG, Polstermöbelfabrik, Brühlstrasse 21,
 5304 Endingen. Rechtsnachfolgerin des Designers
 Johannes Weibel, Untersiggenthal





2480



2485

Cl. 6-01 130 340 26.01.2004
2 Designs – Barhocker
Eduard Buff, Technikumstrasse 52, 8400 Winterthur



Barhocker 4



Barhocker 5



Cl. 6-03 130 341 04.12.2003
1 Design – Tisch
Vitra Patente AG, Klüfenfeldstrasse 22, 4132 Muttenz.
Rechtsnachfolgerin des Designers Christoph Ingenhoven,
Düsseldorf





1

Cl. 6-03 **130 342** 03.12.2003
 1 Design – Möbelbemusterung
 Ralph Gehrig, Riehenteichstrasse 56, 4058 Basel.
 Vertr.: Urs Glarner Training GmbH, Basel

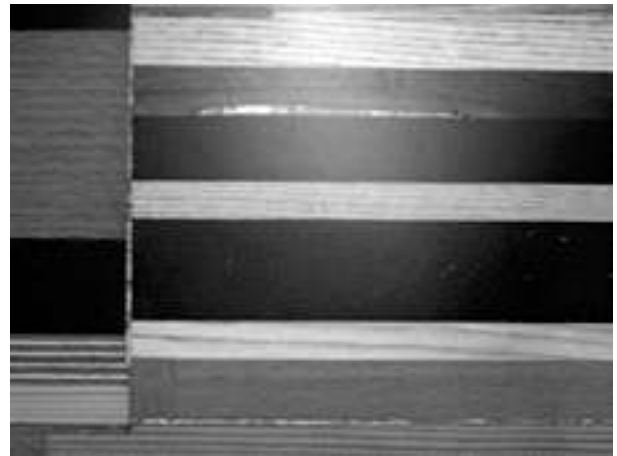
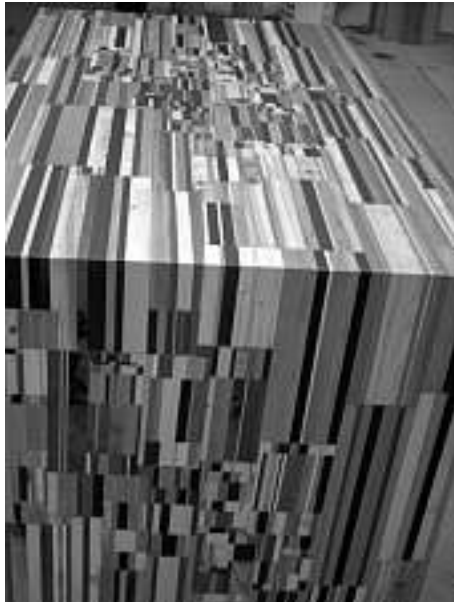

Phoenix

Cl. 6-03 **130 343** 18.12.2003
 1 Design – Tisch
 Mobimex AG, Birren 19, 5703 Seon. Rechtsnachfolgerin
 des Designers Dante Bonuccelli, Milano



Wangentisch TIX

Cl. 6-03 130 344 05.01.2004
2 Designs - Tisch
HMS Event Service GmbH, Austrasse 141, Heilbronn (DE).
Rechtsnachfolgerin des Designers Klaus Hampp, Heilbronn.
Vertr.: Isler & Pedrazzini AG, Zürich
Prior.: Deutschland 09.07.2003



M12867/1

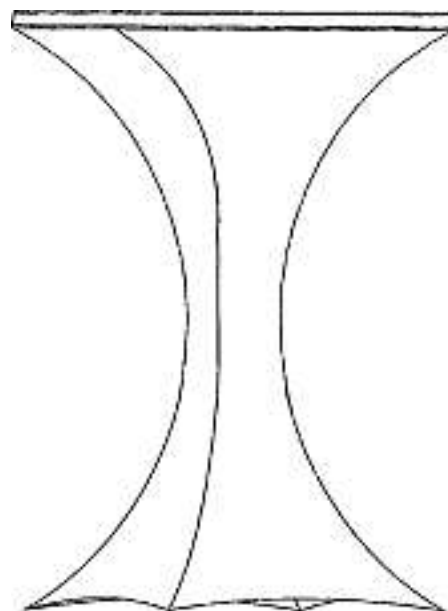
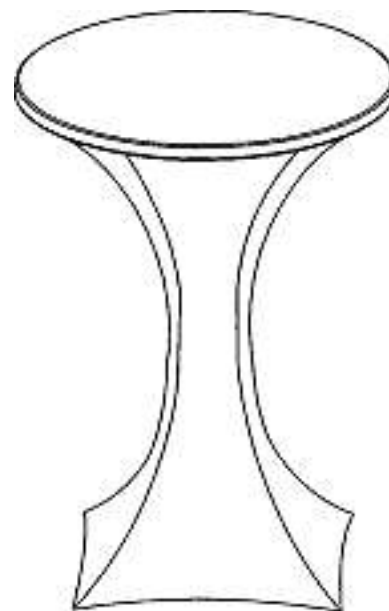

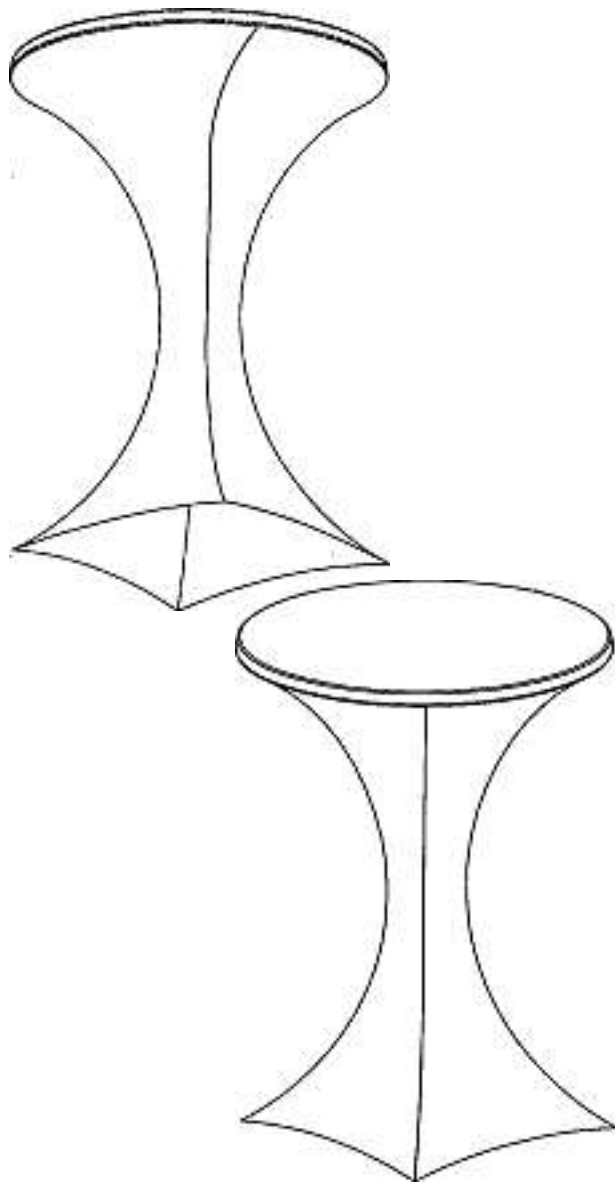

M12867/2

Cl. 6-04 130 345 18.12.2003
 1 Design – Regal
 Bruno Messerli, Moosacker 134, 4587 Aetingen



Event-Regal



Cl. 6-04 130 346 18.12.2003
 1 Design – Regal
 Bruno Messerli, Moosacker 134, 4587 Aetingen



PB-Regal

Cl. 6-05 130 347 04.12.2003
 1 Design – Universalmöbel
 Kurt Spalinger, via Buonamano 19, 6612 Ascona





Cl. 6-05 130 348 12.01.2004
1 Design – Sitz- und Stehtisch
Merwag Gibswil AG, Industrie Eschmatt, 8498 Gibswil-Ried.
Rechtsnachfolgerin des Designers Renato Wehrli, Turbenthal.
Vertr.: IP&T Rentsch und Partner, Zürich

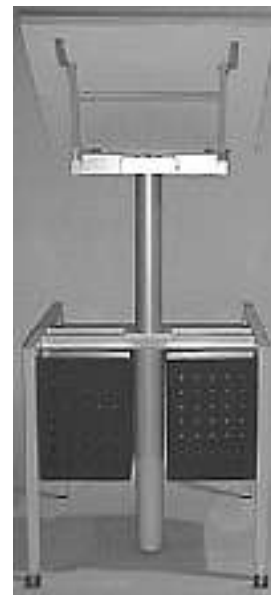
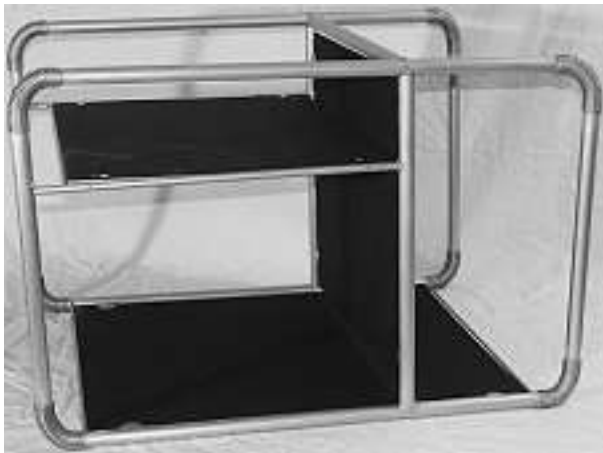



D1630CH00

Cl. 7-01 130 349 10.12.2003
1 Design – Behälter
Tchibo Frisch-Röst-Kaffee GmbH, Überseering 18, Hamburg
(DE). Rechtsnachfolgerin des Designers Karl-Heinz Landwehr,
Hamburg.
Vertr.: E. Blum & Co., Zürich



A-2003/1060

Cl. 7-01 130 350 26.12.2003
1 Design – Schale
David Weisser, Ottostrasse 17, 8005 Zürich





OTTO 171

Cl. 7-02 **130 351** 05.12.2003
 1 Design – Gartencheminée
 Nouvel AG, Triengen, Industrie Grund, 6234 Triengen.
 Rechtsnachfolgerin des Designers Werner Bähler, Safnern



303364

Cl. 7-02 130 352 09.12.2003
 1 design – machine à café
 Domteknika S.A., chemin de Saint-Joux 16b,
 2520 La Neuveville. Ayant cause du designer Jean-Luc
 Thuliez, Le Landeron.
 Mand.: Cabinet Roland Nithardt, Conseils en Propriété
 Industrielle SA, Yverdon-les-Bains
 Description du design: Tête de la machine et grille en métal,
 reste de la machine en matières plastiques



12-2003

Cl. 7-02 130 353 19.12.2003
 2 Designs – Grilltoaster
 Breville Pty Ltd, Building 2, Port Air Industrial Estate,
 1A Hale Street, Botany, NSW (AU). Rechtsnachfolgerin der
 Designer Bryan McHutchison, Kellyville und Mario Barker,
 Annandale.
 Vertr.: Keller & Partner Patentanwälte AG, Bern
 Prior.: Australien 02.07.2003, 02.07.2003

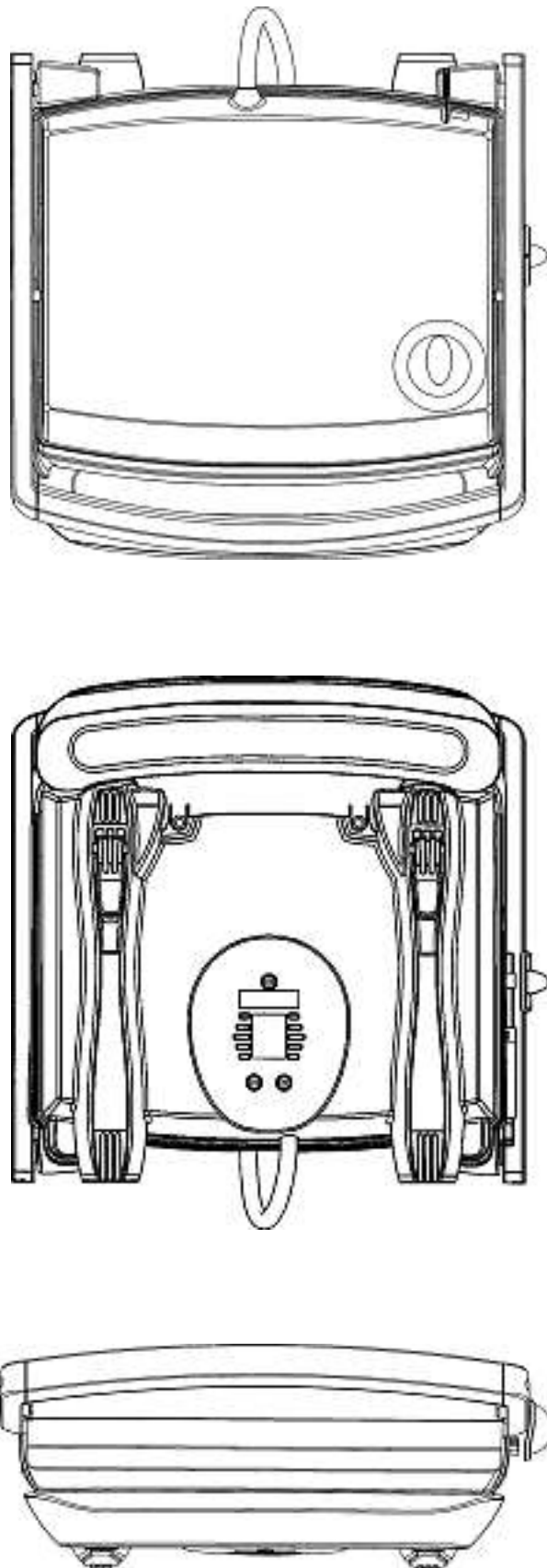

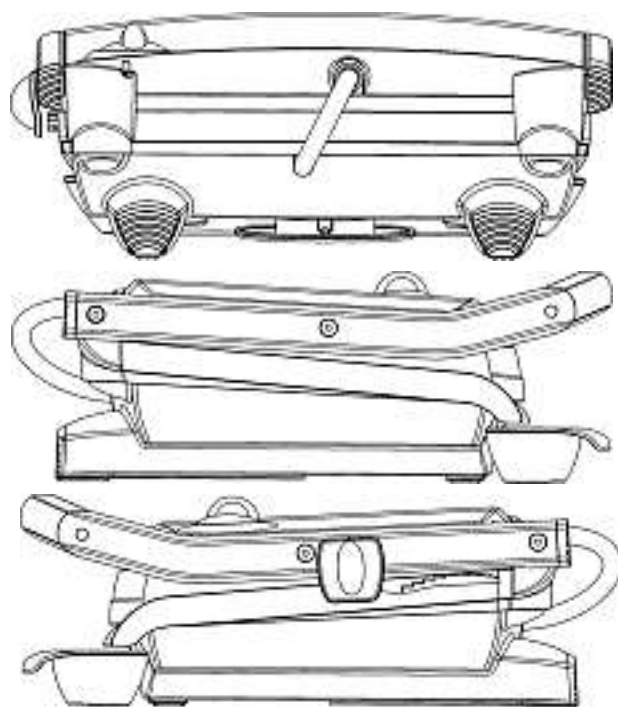



2

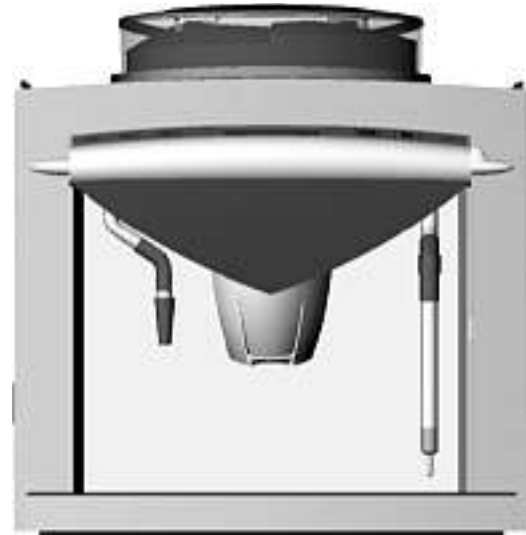

Cl. 7-02 **130 354** 09.01.2004
1 Design – Kaffeemaschine
Steiner AG Weggis, Röhrlistrasse 22, 6353 Weggis.
Rechtsnachfolgerin des Designers Hubert Bruttin, Venthône.
Vertr.: Luchs & Partner, Zürich



Tiger 2003

Cl. 9-07 130 355 09.12.2003
 2 Designs – Drehverschluss
 Semadeni AG, Tägerlistrasse 35-39, 3072 Ostermundigen.
 Rechtsnachfolgerin des Designers Patrick Semadeni,
 Muri b. Bern



Gewürzverschluss klein

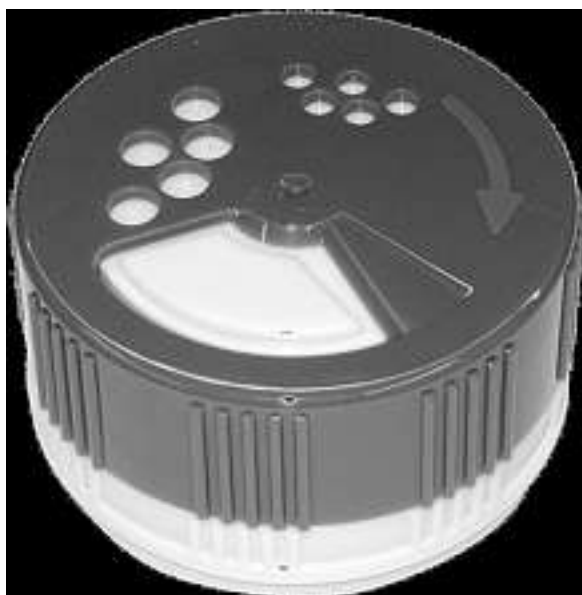

Gewürzverschluss gross

Cl. 10-02 130 356 17.12.2003
 1 Design – Armbanduhr
 Aurema SA, Jurastrasse 74, 2540 Grenchen. Rechtsnach-
 folgerin der Designerin Ursula von Burg, Grenchen



Parallel-Crystal-Watch 1217

Cl. 10-02 130 357 17.12.2003
 1 Design – Armbanduhr
 Aurema SA, Jurastrasse 74, 2540 Grenchen. Rechtsnach-
 folgerin der Designerin Ursula von Burg, Grenchen



Rubber-Crystal-Watch-1217

Cl. 10-02 130 358 17.12.2003
 1 Design – Armbanduhr
 Roland Schilling, Mittelstrasse 20, 2502 Biel





1

Cl. 10-05 130 359 10.12.2003
2 Designs – Sensoren
Bürkert Werke GmbH & Co. KG, Christian-Bürkert-Strasse 13-17,
Ingelfingen (DE). Rechtsnachfolgerin des Designers
Bernd Rottermann, Birkenau.
Vertr.: Troesch Scheidegger Werner AG, Zumikon.
Prior.: Deutschland 13.06.2003



D300023CH-1



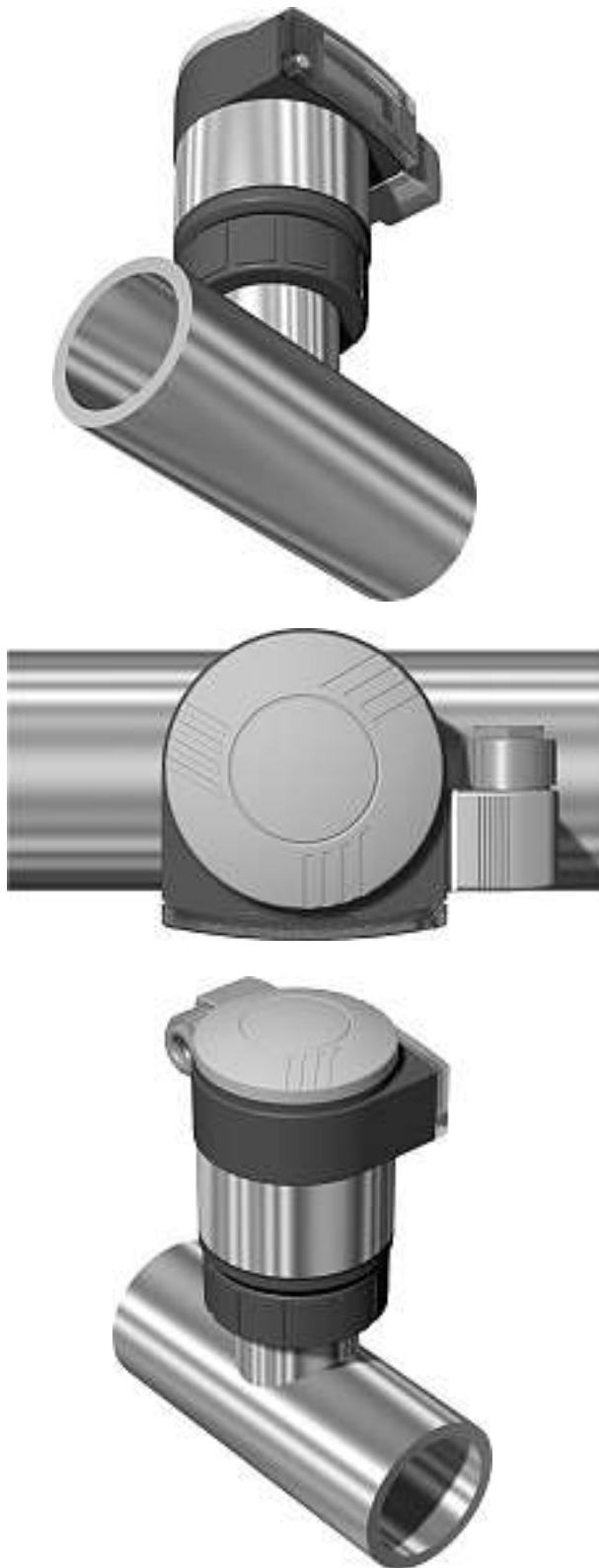

D300023CH-2

Cl. 11-01 130 360 12.12.2003
 1 Design – Schmuck
 Yvonne Meyer, Im Steinacker 2, 4142 Münchenstein



Handschmuck1

Cl. 11-01 130 361 17.12.2003
 3 Designs – Armband, Koller, Ring
 Aurema SA, Jurastrasse 74, 2540 Grenchen. Rechtsnachfolgerin der Designerin Ursula von Burg, Grenchen



Rubber-Crystal-Bracelet-1217



Rubber-Crystal-Necklace-1217



Rubber-Crystal-Ring-1217

Cl. 11-02 130 362 04.12.2003
 1 Design – Windlicht
 Stephan Geiser, Worbstrasse 312b, 3073 Gümligen





windlicht-2003

Cl. 11-02 **130 363** 15.12.2003
 1 Design – Windlicht
 Konrad Affolter, Bühlstrasse 46, 3012 Bern



1

Cl. 11-05 **130 364** 10.12.2003
 1 Design – Leuchtscheibe
 Elektro Brönnimann AG, Neumattstrasse 6, 4450 Sissach.
 Rechtsnachfolgerin des Designers Pascal Benz, Rünenberg





FCB-Leuchtscheibe



Cl. 12-12 **130 365** 19.12.2003
 3 Designs – Kinderwagen und Teile davon
 Stokke Gruppen AS, Hahjem, Skodje (NO). Rechtsnachfolgerin der Designer Bjorn Refsum, Alesund und Hilde Angelfoss Oxseth, Alesund.
 Vertr.: Frei Patentanwaltsbüro, Zürich
 Prior.: Norwegen 03.07.2003



D0090CH-1



D0090CH-2



D0090CH-3



Cl. 12-13 **130 366** 23.12.2003
1 Design – Raupenfahrzeug
Ulrich Gertsch, Ziegeleistrasse 32c, Postfach 54, 3612 Steffisburg

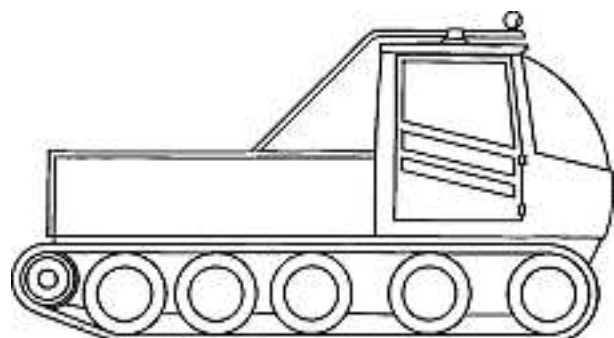

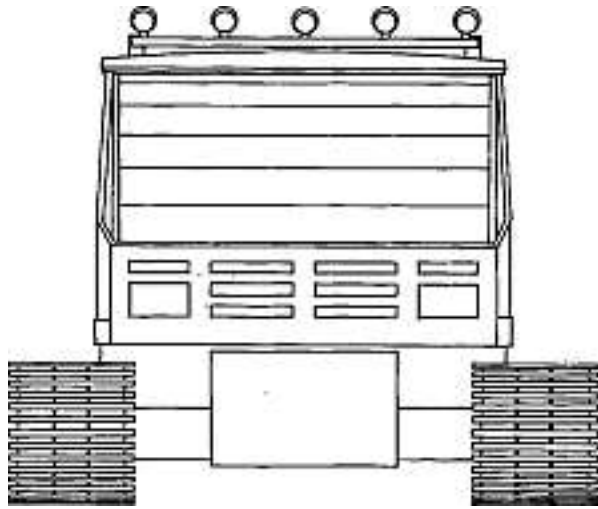

Cl. 12-15 **130 367** 20.02.2004
1 design – pneu pour véhicule automobile
The Yokohama Rubber Co., Ltd, 36-11, Shimbashi 5-chome,
Minato-ku, Tokyo (JP). Ayant cause des designers Kenichiro
Sugitani, Kanagawa-ken; Yukihiro Ohki, Kanagawa-ken;
Hirohisa Hazama, Kanagawa-ken et Kenichiro Endo, Tokyo.
Mand.: Novagraaf International SA, Les Avanchets
Prior.: Japon 11.09.2003

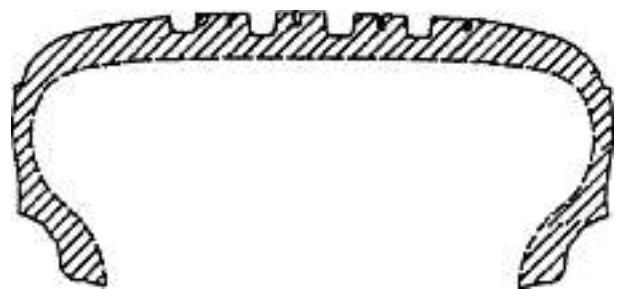
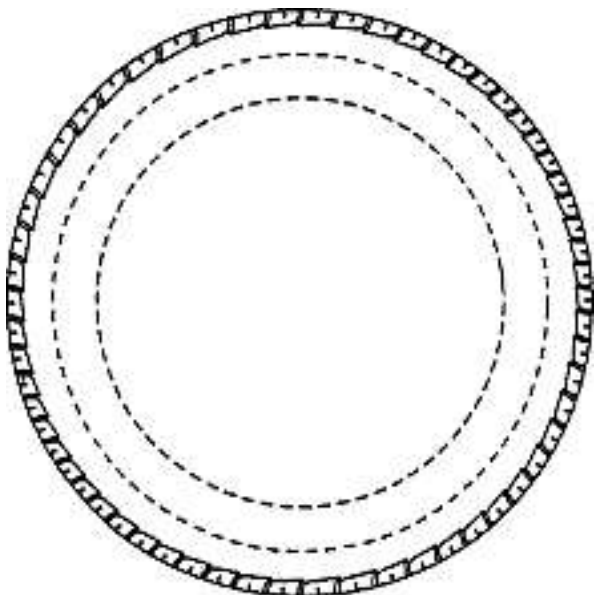
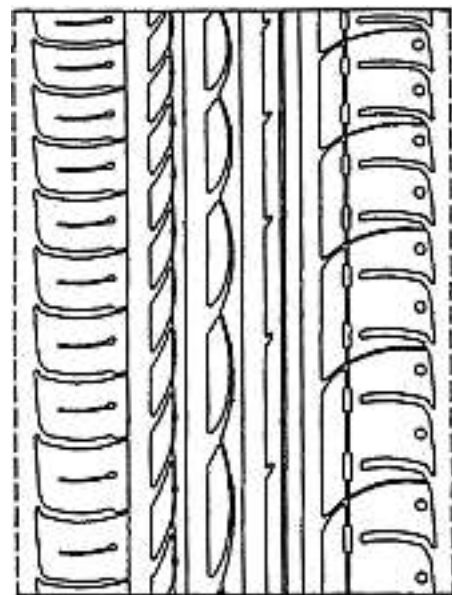
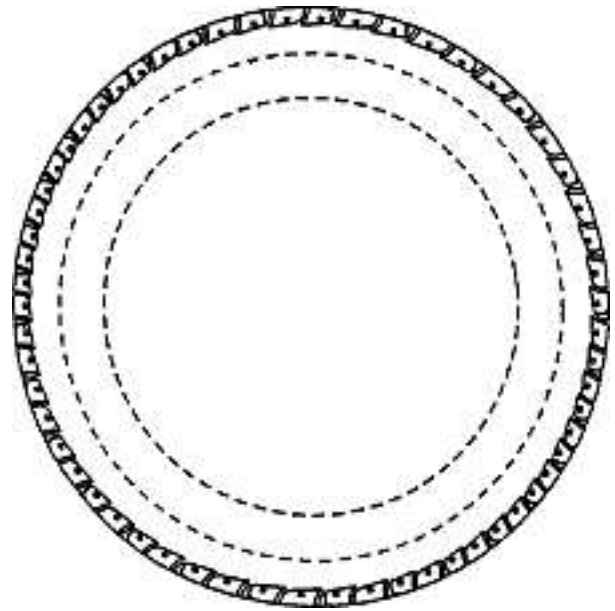

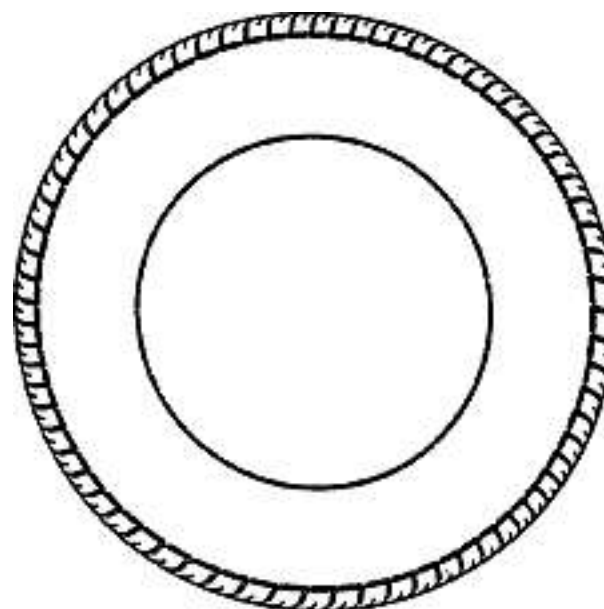
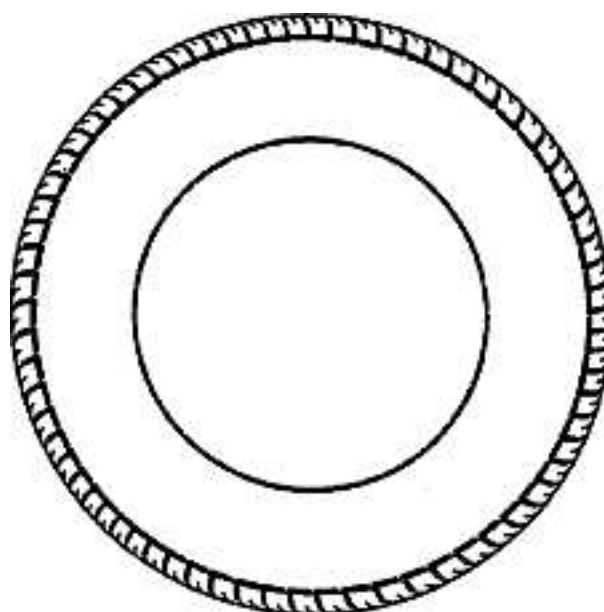
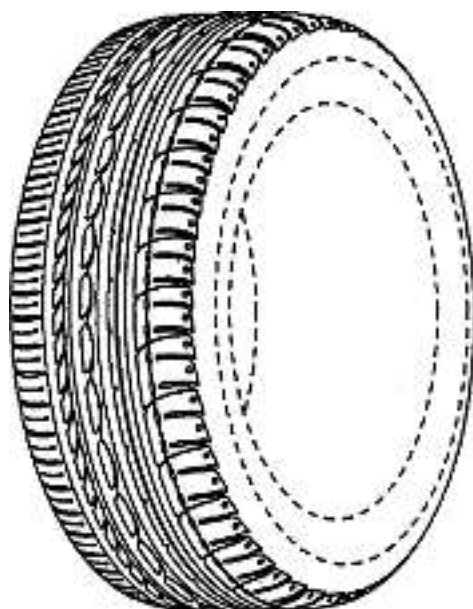
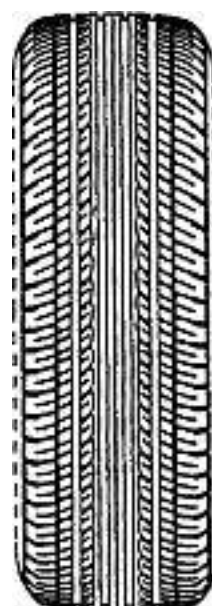
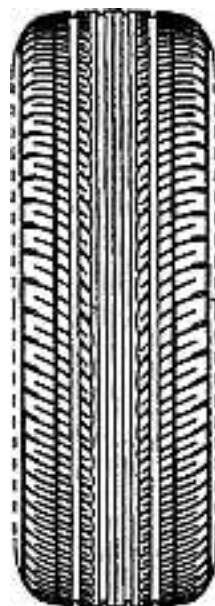
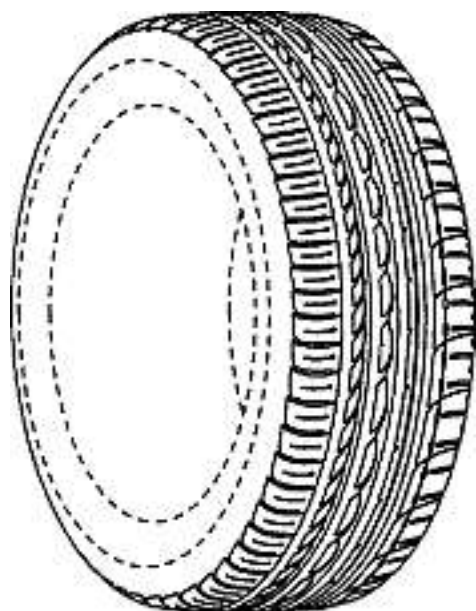

MB 51235

Cl. 12-15 **130 368** 20.02.2004
1 design – pneu pour véhicule automobile
The Yokohama Rubber Co., Ltd, 36-11, Shimbashi 5-chome,
Minato-ku, Tokyo (JP). Ayant cause des designers Kenji
Yamane, Kanagawa-ken; Hirohisa Hazama, Kanagawa-ken;
Izumi Kuramochi, Tokyo et Hiroshi Tokizaki, Tokyo.
Mand.: Novagraaf International SA, Les Avanchets
Prior.: Japon 11.09.2003

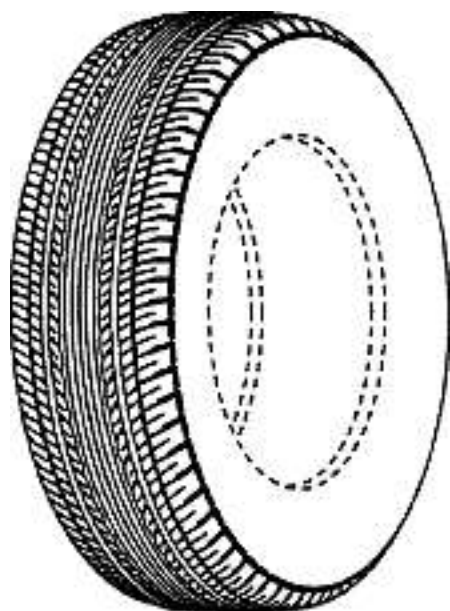
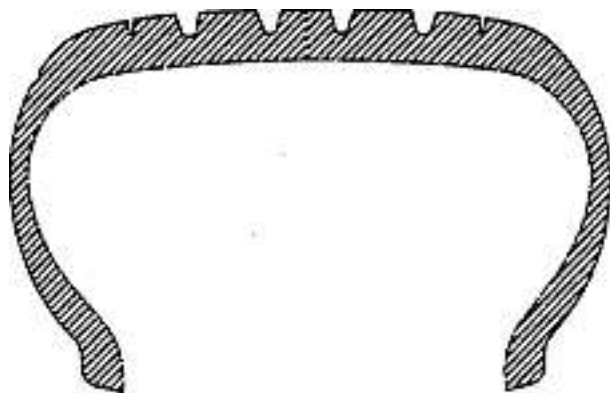
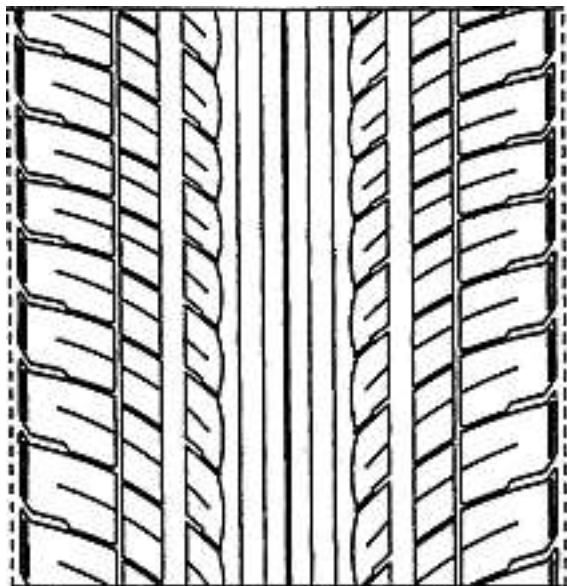

Cl. 12-15

130 369

20.02.2004

1 design – pneu pour véhicule automobile
 The Yokohama Rubber Co., Ltd, 36-11, Shimbashi 5-chome,
 Minato-ku, Tokyo (JP). Ayant cause des designers Kenichiro
 Sugitani, Kanagawa-ken; Yukihiro Ohki, Kanagawa-ken;
 Hirohisa Hazama, Kanagawa-ken et Kenichiro Endo, Tokyo.
 Mand.: Novagraaf International SA, Les Avanchets
 Prior.: Japon 11.09.2003

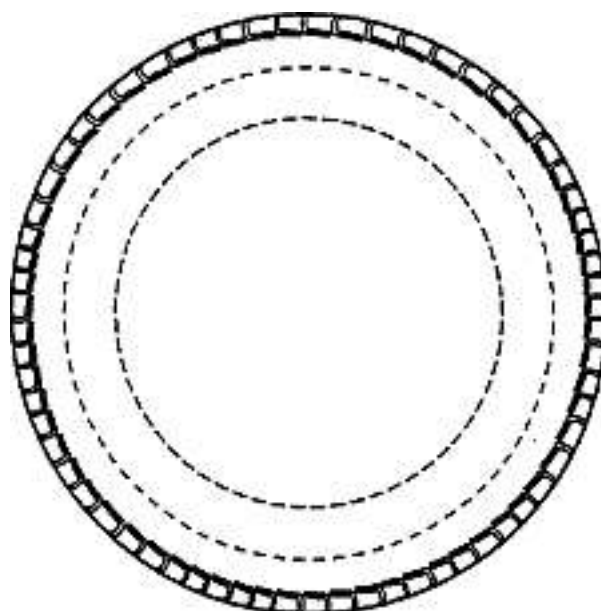
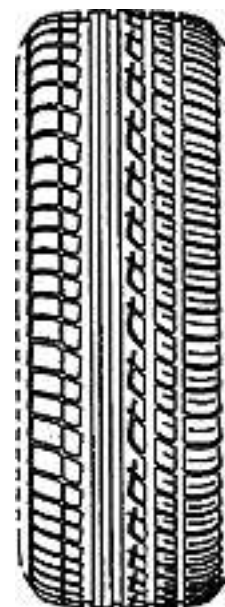
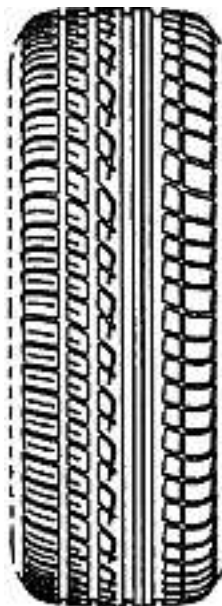

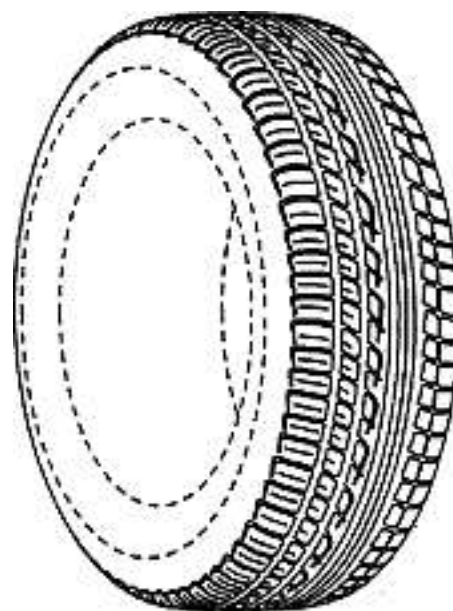
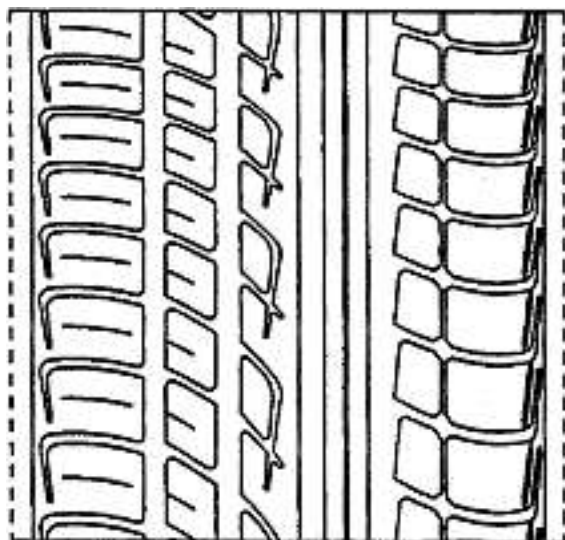
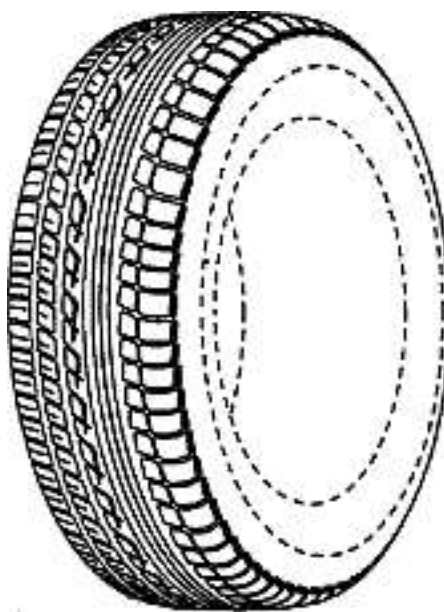
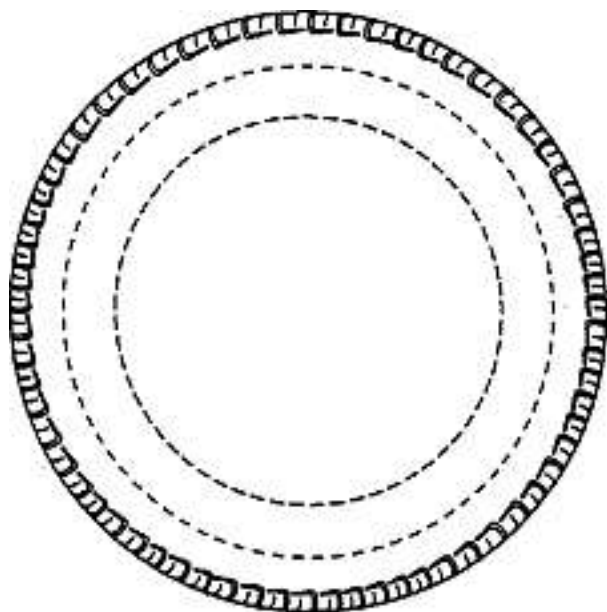

MB 51237

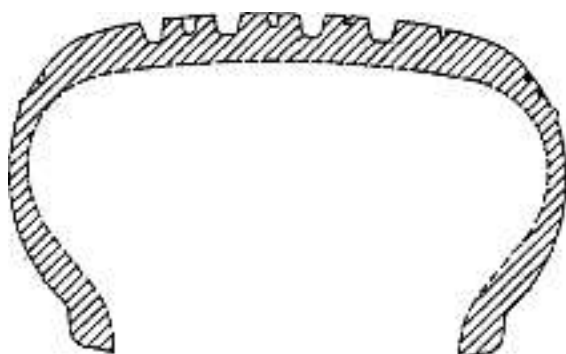

Cl. 12-16 **130 370** 04.02.2004
1 Design – Rad für ein Kraftfahrzeug
Dr.Ing. h.c.F. Porsche Aktiengesellschaft, Porscheplatz 1,
Stuttgart (DE). Rechtsnachfolgerin des Designers
Matthias Kulla, Leonberg.
Vertr.: Isler & Pedrazzini AG, Zürich
Prior.: Deutschland 08.08.2003



M12879



Cl. 12-16 **130 371** 04.02.2004
 1 Design – Rad für ein Kraftfahrzeug
 Dr.Ing. h.c.F. Porsche Aktiengesellschaft, Porscheplatz 1,
 Stuttgart (DE). Rechtsnachfolgerin des Designers
 Matthias Kulla, Leonberg.
 Vertr.: Isler & Pedrazzini AG, Zürich
 Prior.: Deutschland 08.08.2003



M12877



Cl. 14-04 **130 372** 05.02.2004
1 Design – Bildschirmanzeige
OPENLIMIT Holding AG, Zugerstrasse 76b, 6341 Baar.
Rechtsnachfolgerin des Designers Thomas Joss, Zürich.
Vertr.: Froriep Renggli, Zürich



10004374

Cl. 15-05 **130 373** 14.01.2004
 1 Design – Kleinteilewäscher
 Frey-Kunststoffe AG, Furtbachstrasse 13, 8107 Buchs ZH.
 Rechtsnachfolgerin des Designers Bruno Spadin, Oberägeri



1

Cl. 15-06 **130 374** 13.01.2004
 1 Design – Druckarm
 Trützschler GmbH & Co. KG, Duvenstrasse 82-92,
 Mönchengladbach (DE). Rechtsnachfolgerin der Designer
 Rino Bossy, Wülfrath und Armin Leder, Mönchengladbach.
 Vertr.: A. Braun, Braun, Héritier, Eschmann AG, Basel.
 Prior.: Deutschland 14.07.2003, 14.07.2003, 18.11.2003



D. 4/2004

Cl. 19-02 **130 375** 20.02.2004
 1 Design – Mehrzweck-Handgerät
 C Tech AG, Engadinstrasse 2, 7001 Chur. Rechtsnach-
 folgerin des Designers Hanspeter Leins, Nagold.
 Vertr.: E. Blum & Co., Zürich
 Prior.: EM 29.08.2003

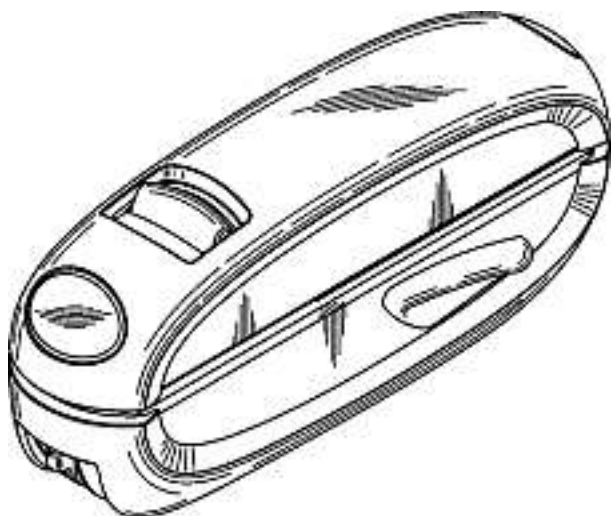

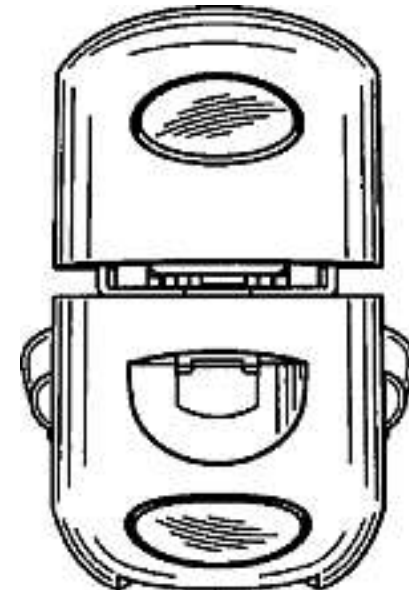
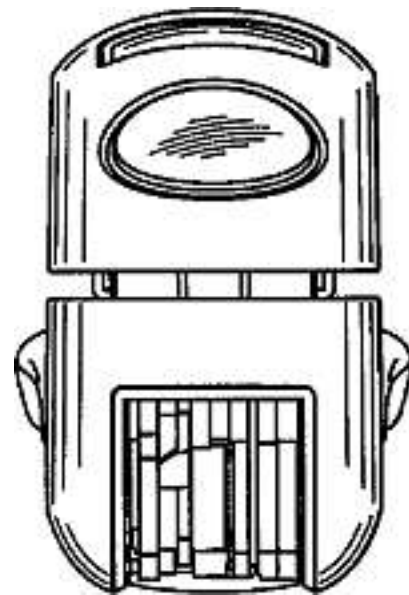
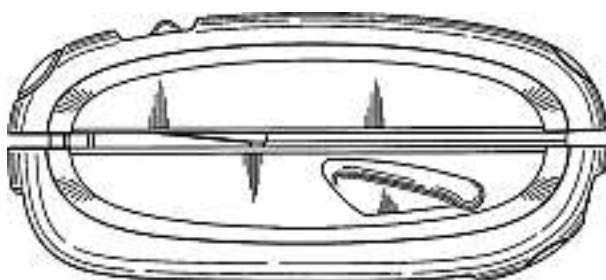
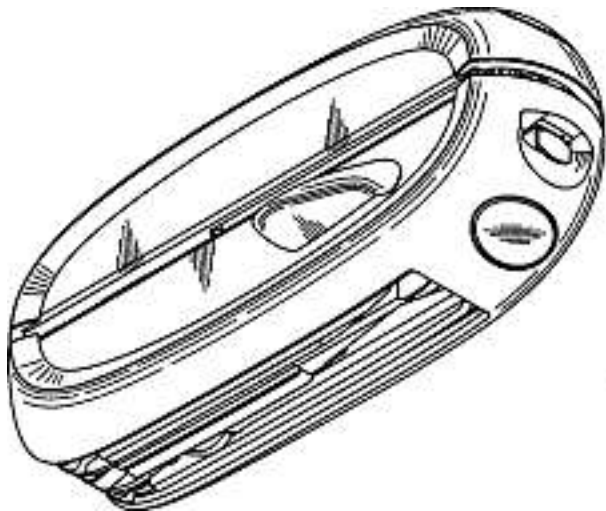
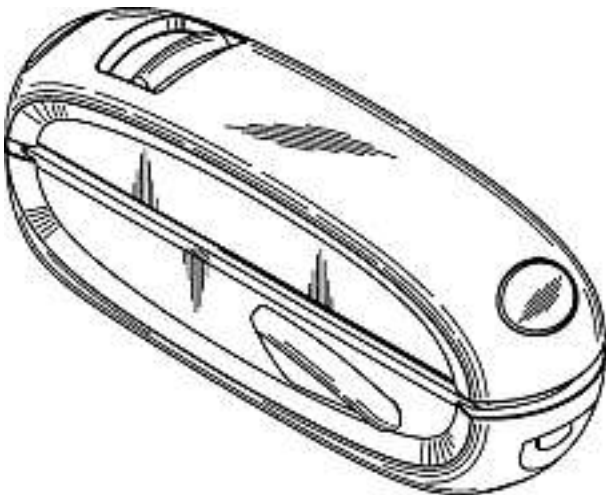
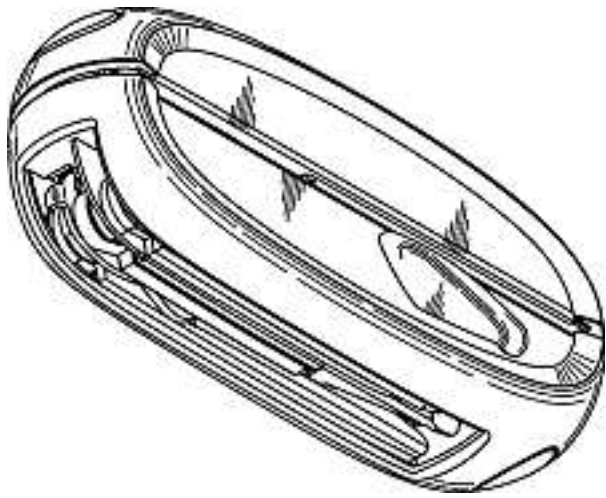

A-2004/1008

Cl. 20-02 130 376 19.12.2003
2 designs – présentoirs
Pozzo di Borgo Styling SA, Quai Perdonnet 34, 1800 Vevey.
Ayant cause du designer Pascal Pozzo di Borgo, Vevey

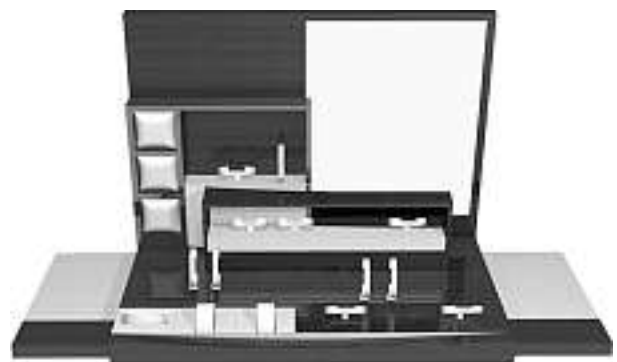

LOPOZZO0001

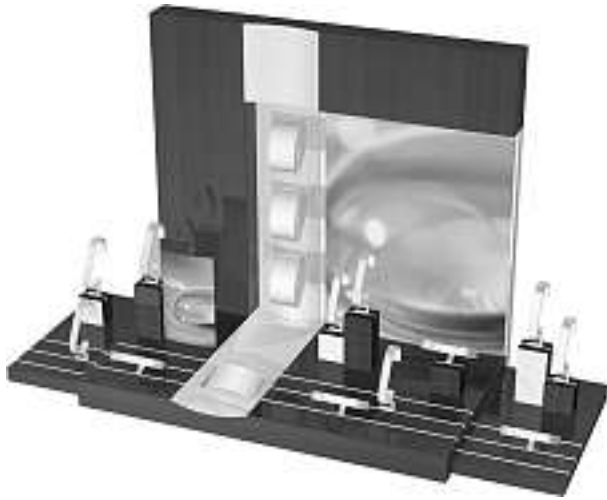

LOPOZZO0002

Cl. 21-01 **130 377** 18.12.2003
 1 Design – Spielzeug
 VELE Marketing SA, Bottmingerstrasse 59, 4102 Binningen.
 Rechtsnachfolgerin des Designers Alex Hochstrasser, Zürich



AP_SCR_04



Cl. 21-02 **130 378** 28.11.2003
 1 Design – Sportball
 Reusch International Licence GmbH & Co. KG, Metzinger
 Strasse 75, Metzingen (DE). Rechtsnachfolgerin des
 Designers Jürg Buchmeier, Valencia.
 Vertr.: Mattli Hew Meisser Weinmann, Davos Platz





3505-CH-21-DESIGN

Cl. 23-01, 02 **130 379** 04.12.2003
21 Designs – Armaturen, Seifenhalter, Badtuchhalter
Jado AG, Paul-Ehrlich-Strasse 5, Rödermark (DE). Rechts-
nachfolgerin der Designer Achim Pohl, Darmstadt und
Thomas Fiegl, Darmstadt.
Vertr.: ServoPatent GmbH, Zürich



1



2



3



4



5



6



7



8



9



10



11



12



13



14



15



16



17



18



19





20



21

Cl. 23-01, 02 **130 380** 04.12.2003
28 Designs – Armaturen, Seifenhalter, Badtuchhalter
Jado AG, Paul-Ehrlich-Strasse 5, Rödermark (DE). Rechts-
nachfolgerin des Designers Matteo Thun, Mailand.
Vertr.: ServoPatent GmbH, Zürich



1



2



3



4



5

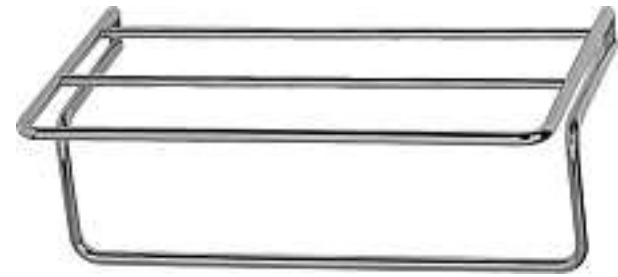

6



7



8



9



10



11



12



13



16



14



17



15



18



19



20



21



22



23



24



25



26



27



28

Cl. 23-01 130 381 10.12.2003
 8 Designs – Ventil
 Bürkert Werke GmbH & Co. KG, Christian-Bürkert-Strasse 13-17,
 Ingelfingen (DE). Rechtsnachfolgerin des Designers
 Bernd Rottermann, Birkenau.
 Vertr.: Troesch Scheidegger Werner AG, Zumikon
 Prior.: Deutschland 13.06.2003





D300024CH-1



D300024CH-2





D300024CH-3



D300024CH-4



D300024CH-5





D300024CH-6



D300024CH-7



D300024CH-8

Cl. 24-01 **130 382** 23.01.2004
1 design – prise pour fluide pour équipement médical
Trilux-Lenze GmbH & Co. KG, Heidestrasse 4, Arnberg (DE).
Ayant cause du designer Ulrich Zucker, Ehringshausen.
Mand.: Katzarov S.A., Genève
Prior.: EM 30.07.2003



14573/CH

Cl. 24-02 130 383 28.01.2004
1 Design – Inhalationsapparat
Meridica Limited, Cambridge Technology Centre, Melbourn/Herts
(GB). Rechtsnachfolgerin der Designer Martin Douglas Pearl,
Over; Andrew Mark Bryant, Bassingbourn cum Kneesworth und
Jonathan Hogwood, Melbourn.
Vertr.: Patentanwälte Schaad, Balass, Menzl & Partner AG,
Zürich
Prior.: EM 06.08.2003



1

Cl. 25-01 **130 384** 16.12.2003
 1 Design – Klemmkassette
 E. Pfister & Cie AG, Neue Winterthurerstrasse 20, 8305
 Dietlikon.
 Rechtsnachfolgerin des Designers Tobias E. Pfister,
 Boppelsen

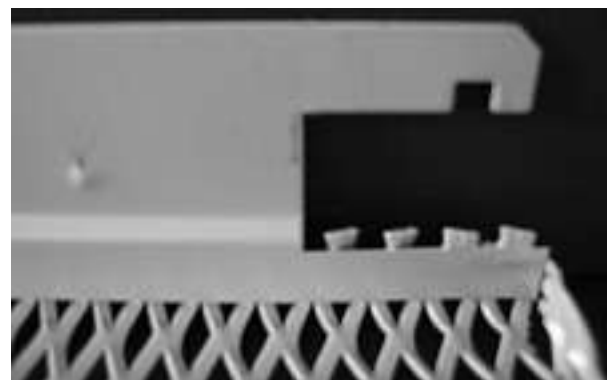
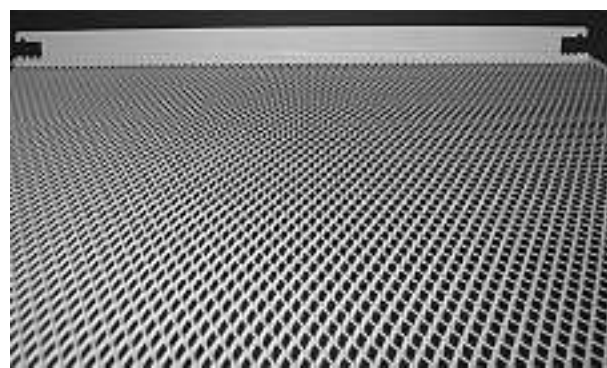

113-01-84007

Cl. 25-02 **130 385** 15.12.2003
 2 Designs – Schneefänger
 Ridem AG, Rinaustrasse 284, 4303 Kaiseraugst. Rechtsnach-
 folgerin des Designers Urs Ritter, Kaiseraugst.
 Vertr.: A. Braun, Braun, Héritier, Eschmann AG, Basel

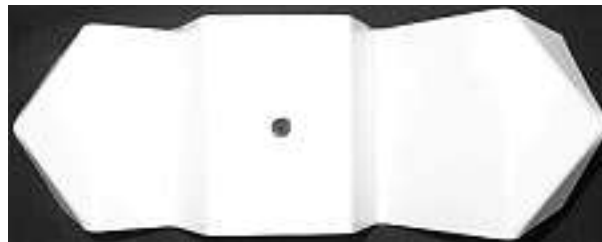

1



2

Cl. 25-02 130 386 18.02.2004
 1 Design – Kaminhut
 Ohnsorg Söhne AG, Knonauerstrasse 5, 6312 Steinhausen.
 Rechtsnachfolgerin des Designers Adrian Ohnsorg,
 Steinhausen.
 Vertr.: Rottmann, Zimmermann + Partner AG, Zürich



25648

Cl. 26-01 130 387 03.12.2003
 1 Design – Kerzenleuchter
 Michael Hübscher, St. Alban-Vorstadt 80, 4052 Basel



103.2003

Cl. 26-05 130 388 30.12.2003
1 design – lampe
Gabrielle Blättler, 10, rue de l'Ecole-de-Médecine,
1205 Genève

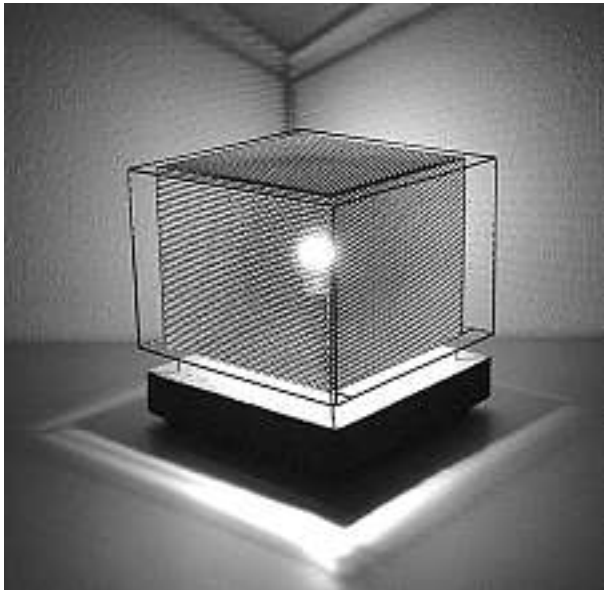
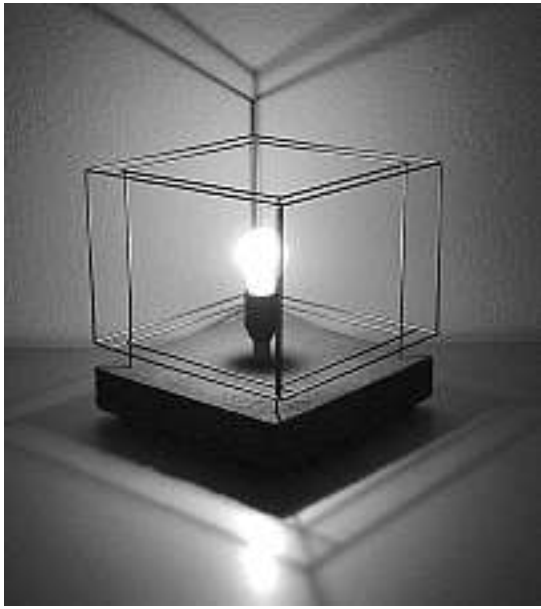

CUBO LIBRE

Cl. 26-05 130 389 07.01.2004
2 Designs – Leuchte
ProLux Licht AG, Hübelacherstrasse 15, Industrie Birrfeld
Nord, 5242 Lupfig. Rechtsnachfolgerin des Designers
Uli Sidler, Zürich



T 111-rund



T 111-tri



14504/CH-2

Cl. 26-05 **130 390** 13.02.2004
2 designs – éclairage
Trilux-Lenze GmbH & Co. KG, Heidestrasse 4,
Arnsberg (DE). Ayant cause du designer Ulrich Zucker,
Ehringshausen.
Mand.: Katzarov S.A., Genève
Prior.: EM 02.09.2003



14504/CH-1



**Verlängerungen
Prolongations
Prolongazioni**

117 205 Cl. 24-03 1 Design

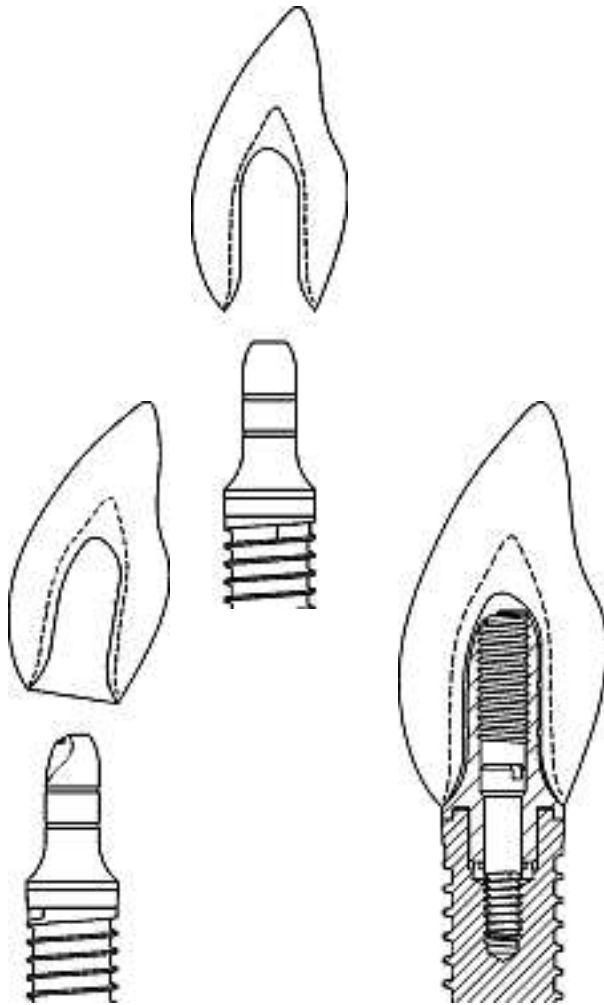

87

117 240 Cl. 6-03 2 Designs

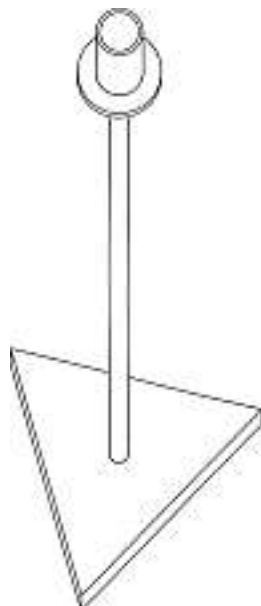

03

266

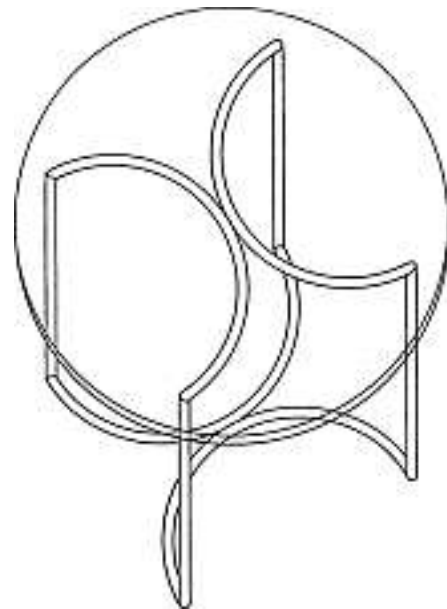

05

117 252 Cl. 10-04 2 Designs



1

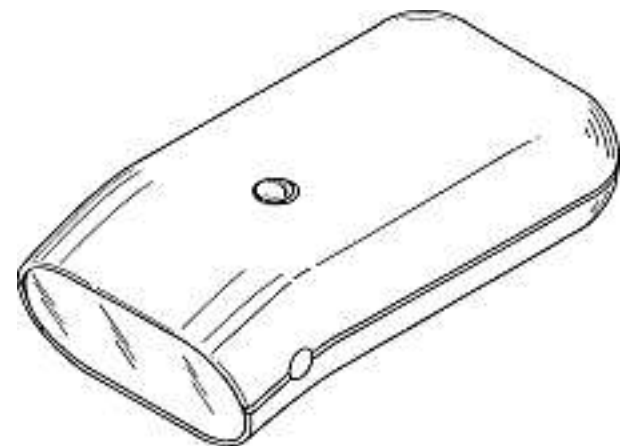
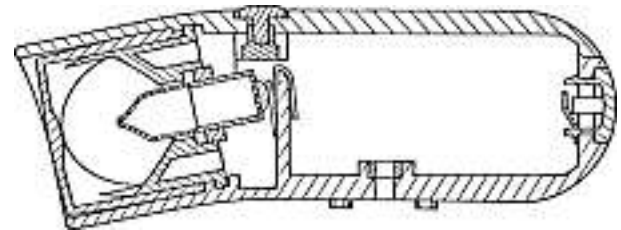
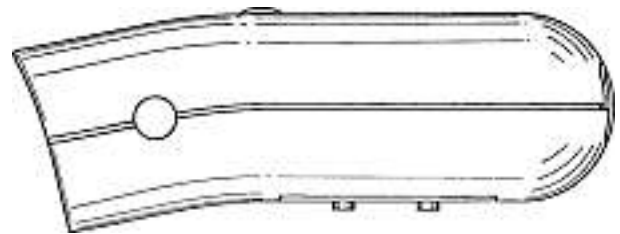
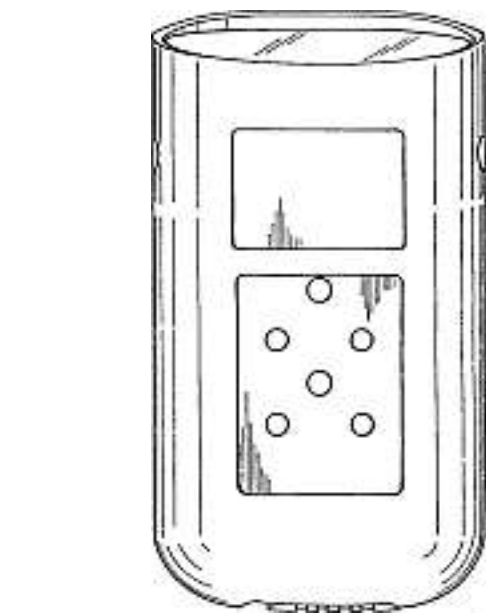
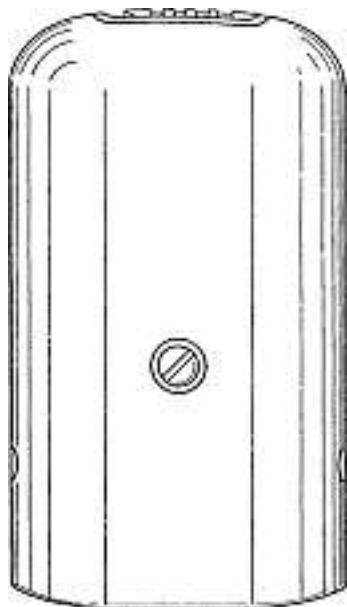
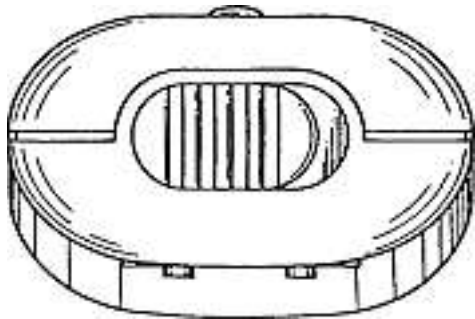
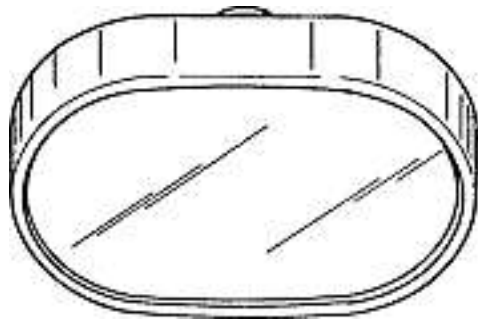

2

117 343 Cl. 10-01 1 Design

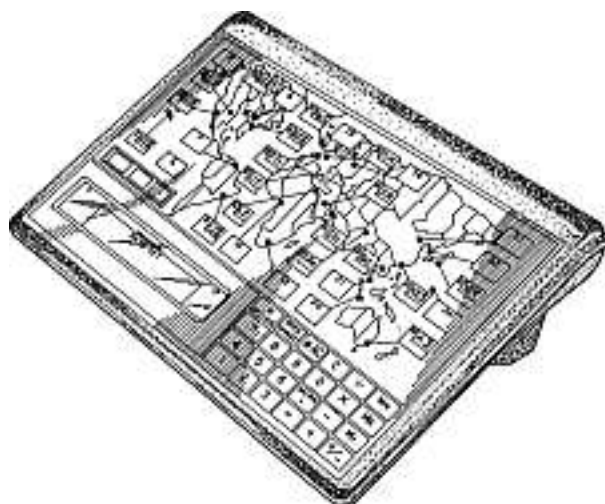
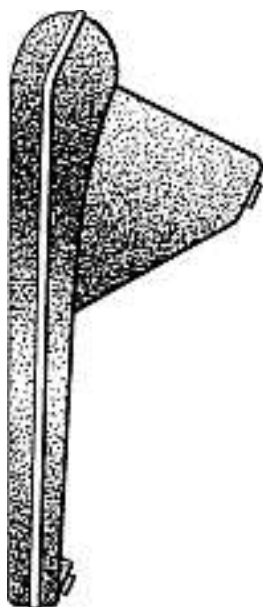
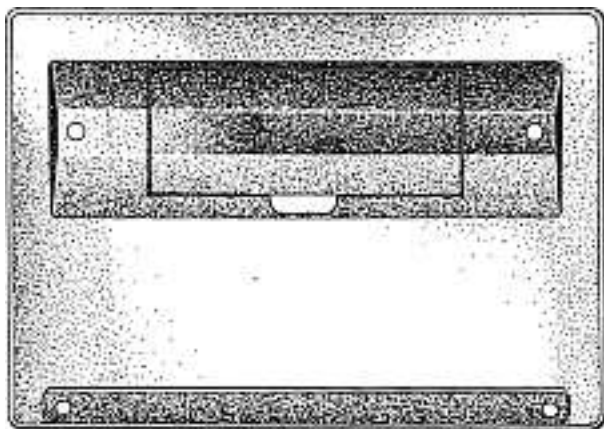
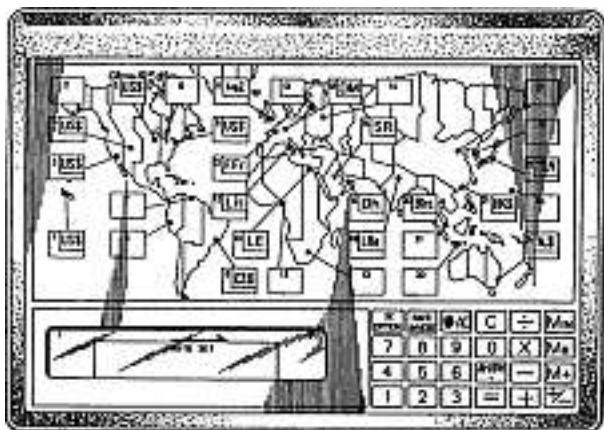

1

121 167	Cl.	25-02	1 Design
121 208	Cl.	15-03	1 Design
121 230	Cl.	15-07	1 Design
121 237	Cl.	2-07	3 Designs
121 268	Cl.	21-01	1 Design
121 441	Cl.	26-05	1 Design
125 719	Cl.	10-02	1 Design
125 794	Cl.	1-01	1 design
125 803	Cl.	7-01	1 Design
125 806	Cl.	8-08	1 Design
125 868	Cl.	26-02	1 Design
125 894	Cl.	14-02	2 Designs
125 895	Cl.	16-03	1 Design
125 979	Cl.	30-04	2 Designs
126 095	Cl.	6-06	1 Design
126 116	Cl.	13-03	1 Design
126 137	Cl.	26-02	1 design
126 145	Cl.	6-01	14 Designs
126 154	Cl.	9-01	2 designs
126 170	Cl.	24-99	1 Design
126 182	Cl.	7-01	6 Designs

Mutationen Modifications Modificazioni

117 205

Übertragung an: Thommen Medical AG, Hauptstrasse 87,
4437 Waldenburg

122 210

Namensänderung in: IVAC MEDICAL SYSTEMS, Inc.,
10300 Campus Point Drive, San Diego/CA (US).
Namensänderung in: IVAC Holdings, Inc., 10221 Wateridge
Circle, Building A, San Diego/CA (US).
Namensänderung in: ALARIS Medical Systems, Inc.,
10221 Wateridge Circle, Building A, San Diego/CA (US).
Namensänderung in: ALARIS Medical, Inc., 10221 Wateridge
Circle, San Diego/CA (US).
Namensänderung in: ALARIS Medical Systems, Inc.,
10221 Wateridge Circle, San Diego/CA (US)

122 211**122 212**

Namensänderung in: IVAC Holdings, Inc., 10221 Wateridge
Circle, Building A, San Diego/CA (US).
Namensänderung in: ALARIS Medical Systems, Inc.,
10221 Wateridge Circle, Building A, San Diego/CA (US).
Namensänderung in: ALARIS Medical, Inc., 10221 Wateridge
Circle, San Diego/CA (US).
Namensänderung in: ALARIS Medical Systems, Inc.,
10221 Wateridge Circle, San Diego/CA (US)

125 794

neuer Vertr.: Wild Schnyder AG, Zürich

129 791

Transmission à: Christian Noverraz, 37, avenue du Lignon,
Case postale 149, 1219 Le Lignon et Harun Ozdemir,
35, av. Pictet-de-Rochemont, 1207 Genève.
Mand.: Bugnion S.A., Genève 12 - Champel

Löschungen Radiations Radiazioni

116 839	Cl.	5-06	3	Designs
116 876	Cl.	31-00	1	Design
116 904	Cl.	20-03	1	Design
116 966	Cl.	18-01	1	Design
116 999	Cl.	9-01	1	Design
120 670	Cl.	9-03	1	Design
120 699	Cl.	10-07	1	Design
120 710	Cl.	27-06	1	design
125 273	Cl.	2-03	1	Design
125 280	Cl.	6-04	1	Design
125 283	Cl.	7-01	2	designs
125 294	Cl.	9-02	1	Design
125 296	Cl.	9-03	1	design
125 306	Cl.	12-11	1	Design
125 321	Cl.	2-02	7	designs
125 324	Cl.	5-05	2	Designs
125 328	Cl.	6-03	3	Designs
125 330	Cl.	6-09	5	Designs
125 331	Cl.	7-01	6	Designs
125 339	Cl.	12-08	1	design
125 340	Cl.	12-11	1	Design
125 342	Cl.	13-03	1	Design
125 343	Cl.	14-02	10	Designs
125 344	Cl.	14-03	1	design
125 345	Cl.	17-03	1	design
125 353	Cl.	21-02	1	Design
125 355	Cl.	23-03	1	Design
125 357	Cl.	24-04	1	Design
125 359	Cl.	25-02	1	Design
125 360	Cl.	27-05	1	design
125 364	Cl.	3-01	1	Design
125 381	Cl.	9-01	3	Designs
125 389	Cl.	10-02	1	design
125 393	Cl.	14-03	1	Design
125 394	Cl.	14-03	1	Design
125 434	Cl.	20-01	1	design
125 509	Cl.	24-02	1	Design

Berichtigungen Rectifications Correzioni

130 029

Berichtigung bei den Abbildungen: 3. Bild von Design 1 mit
2. Bild von Design 2 austauschen

130 052

Berichtigung Designer:
Sedat Parta, München