

## Nationale Hinterlegungen

In der folgenden Liste werden die beim Eidgenössischen Institut für Geistiges Eigentum hinterlegten Designs publiziert. Dabei sind der Reihe nach angegeben:

- internationale Klassenangaben
- Hinterlegungsnummer
- Hinterlegungsdatum
- Allenfalls Aufschub der Veröffentlichung
- Anzahl der hinterlegten Designs
- Bezeichnung
- Name und Wohnsitz des Hinterlegers oder der Hinterlegerin
- gegebenenfalls Name und Wohnsitz des Designers oder der Designerin
- Name und Geschäftssitz des allfälligen Vertreters oder der Vertreterin
- gegebenenfalls Prioritätsangaben
- gegebenenfalls Beschreibungstext
- Ordnungsnummer
- Reproduktion des Designs

## Internationale Hinterlegungen

Die bei der Weltorganisation für geistiges Eigentum in Genf hinterlegten Muster und Modelle mit Benennung Schweiz geniessen den gleichen Schutz wie national hinterlegte Designs. Sie werden jeweils im Blatt «Bulletin des dessins et modèles internationaux» veröffentlicht. Dieses Publikationsorgan ist deshalb für eine vollständige Recherche unbedingt beizuziehen.

## Topographien

Angaben über die vom Eidgenössischen Institut für Geistiges Eigentum eingetragenen Topographien von Halbleitererzeugnissen werden in folgender Anordnung aufgeführt:

- Eintragsnummer
- Anmeldedatum
- Bezeichnung
- Name und Wohnsitz des Anmelders oder der Anmelderin
- gegebenenfalls Name und Wohnsitz des Herstellers oder der Herstellerin
- Name und Geschäftssitz des oder der allfälligen Bevollmächtigten
- Datum und Ort einer allfälligen ersten geschäftlichen Verbreitung der Topographie

## Dépôts nationaux

Les designs déposés à l'Institut Fédéral de la Propriété Intellectuelle sont publiés dans la liste qui suit. Les indications y relatives sont mentionnées dans cet ordre:

- indications des classes internationales
- numéro de dépôt
- date de dépôt
- le cas échéant, ajournement de la publication
- nombre des designs déposés
- désignation
- nom et domicile du/de la déposant/e
- le cas échéant, nom et domicile du/de la designer
- nom et domicile de l'éventuel/le mandataire
- le cas échéant, indication de priorité
- le cas échéant, description du design
- numéro attribué à chaque design
- reproduction du design

## Dépôts internationaux

Les dessins et modèles déposés à l'Organisation Mondiale de la Propriété Intellectuelle à Genève qui désignent la Suisse jouissent de la même protection que les dépôts nationaux. Ils sont chaque fois publiés dans la feuille «Bulletin des dessins et modèles internationaux». Pour une recherche complète, il est indispensable de consulter ledit organe de publication.

## Topographies

Les indications concernant les topographies des produits semi-conducteurs, enregistrées par l'Institut Fédéral de la Propriété Intellectuelle, sont énumérées dans l'ordre suivant:

- numéro d'enregistrement
- date de dépôt
- désignation
- nom et domicile du/de la déposant/e
- le cas échéant, nom et domicile du/de la producteur/trice
- nom et domicile de l'éventuel/le mandataire
- date et lieu d'une éventuelle première mise en circulation de la topographie

## Depositi nazionali

Nella lista seguente vengono pubblicati i design depositati presso l'Istituto Federale della Proprietà Intellettuale. Sono menzionati nel seguente ordine:

- indicazioni delle classi internazionali
- numero di deposito
- data del deposito
- se del caso, indicazione che la pubblicazione è stata differita
- numero dei design depositati
- designazione
- nome e domicilio del depositante
- se del caso, nome e domicilio del designer
- nome e sede di un eventuale mandatario
- se del caso, indicazioni di priorità
- se del caso, descrizione del design
- numero d'ordine
- riproduzione del design

## Depositi internazionali

I disegni e modelli depositati presso l'Organizzazione Mondiale della Proprietà Intellettuale a Ginevra con denominazione Svizzera godono della medesima protezione del deposito nazionale. Essi vengono pubblicati ogni volta nel foglio «Bulletin des dessins et modèles internationaux». Quest'organo di pubblicazione è da consultare se si vuole effettuare una ricerca completa.

## Topografie

Le indicazioni concernenti le topografie di prodotti a semiconduttori depositati presso l'Istituto Federale della Proprietà Intellettuale sono menzionate nell'ordine seguente:

- numero di registrazione
- data del deposito
- designazione
- nome e domicilio del/la richiedente
- se del caso, nome e domicilio del/la produttore/trice
- nome e sede di un eventuale mandatario
- data e luogo di un'eventuale prima messa in circolazione della topografia

**Hinterlegungen**

**Dépôts  
Deposit**

Ende aufgeschobene Publikation:

Cl. 15-09 **130 876** 14.07.2004

1 Design – Extrusionsschweissgerät  
Hinterleger: LEISTER Process Technologies, Riedstrasse,  
6060 Sarnen

Designer: Giuseppe Di Miceli, Menziken  
Vertreter: ABACUS Patentanwälte, Klocke Späth Barth,  
8134 Adliswil

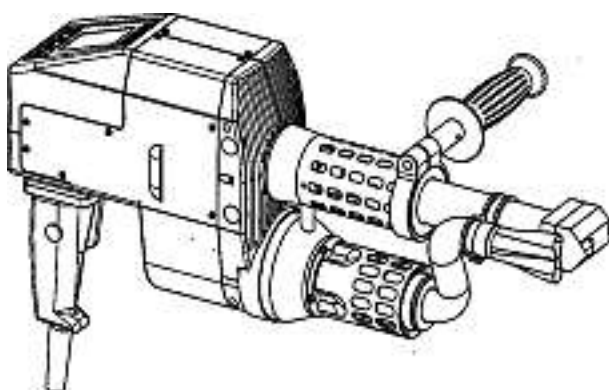
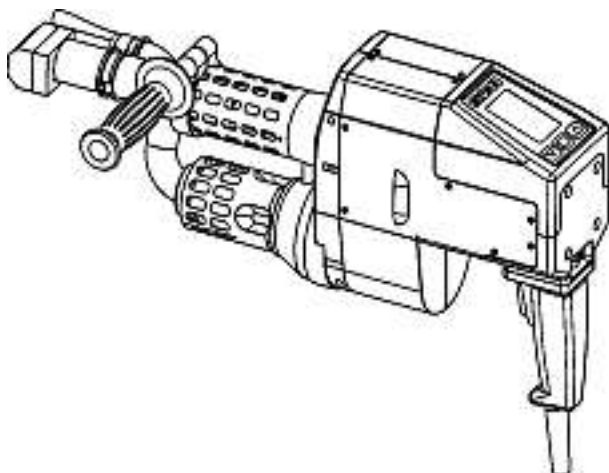

480 / 71 CH

Cl. 02-02 **131 062** 16.08.2004

11 design – dessin pour T-Shirts  
Déposant: Samir Hajoui, 29, rue Sainte Apolline, Paris, FR  
Mandataire: Jonas Messerli, 2000 Neuchâtel

I ♥  
CUT  
KILLER

Cut Killer

I ♥  
Fashion

Fashion

I ♥  
RAP

Rap

I ♥  
HIP HOP

Hip hop

I ♡  
HOUSE

House

I ♡  
LOVE

Love

I ♡  
SWISS  
HIP HOP

Swiss Hip Hop

I ♡  
RAGGA

Ragga

I ♡  
RNB

RNB

I ♡  
SCRATCH

Scratch

I ♡  
SEX

Sex

Cl. 02-02 131 063 27.08.2004  
4 design – veste, blouson, T-shirt, pull  
Déposant: Wydler S.A., 57, route d'Oron, 1615 Bossonnens  
Designer: Frédéric Wydler, Bossonnens





Veste MAST 2006



T-shirt MAST 2006



Blouson MAST 2006





Pull MAST 2006

Cl. 02-05 131 064 30.08.2004  
 1 Design – Kopftuch  
 Hinterleger: Regula Verdet-Fierz, Chasa 70, 7545 Guarda



Fluxfilz

Cl. 02-07 131 065 20.09.2004  
 1 Design – Gurt  
 Hinterleger: Lianel Spengler, Walchlistrasse 10, 8800 Thalwil;  
 Christian Aravena, Schwandenholzstrasse 184, 8046 Zürich;  
 Philipp Semmler, Forchstrasse 354, 8008 Zürich;  
 Patrick Schneider, Alte Landstrasse 95, 8803 Rüschlikon  
 Vertreter: Philipp Semmler, 8008 Zürich



1 Wave-Watcher belt

Cl. 03-01 131 066 05.09.2004  
 1 Design – Tasche  
 Hinterleger: Matthew Lee, Baselstrasse 6, 4202 Duggingen



MOTO AID

Cl. 03-01 **131 067** 22.09.2004  
 1 Design – Werkzeugtasche  
 Hinterleger: Michael Koch, Neumattstrasse 1, 4562 Biberist



Cl. 05-05 **131 068** 10.09.2004  
 21 Design – Gewebe (Textilien)  
 Hinterleger: Sonntex Freizeitprodukte GmbH,  
 Industriestrasse 20, Melsungen, DE  
 Designer: Sabine Ziegler, Gross-Gerau  
 Vertreter: Bovard AG, 3000 Bern 25  
 Priorität: EM, 11.03.2004  
 a (Siehe Farbteil in der Heftmitte)  
 b (Siehe Farbteil in der Heftmitte)  
 c (Siehe Farbteil in der Heftmitte)  
 d (Siehe Farbteil in der Heftmitte)  
 e (Siehe Farbteil in der Heftmitte)  
 f (Siehe Farbteil in der Heftmitte)  
 g (Siehe Farbteil in der Heftmitte)  
 h (Siehe Farbteil in der Heftmitte)  
 i (Siehe Farbteil in der Heftmitte)  
 j (Siehe Farbteil in der Heftmitte)  
 k (Siehe Farbteil in der Heftmitte)  
 l (Siehe Farbteil in der Heftmitte)  
 m (Siehe Farbteil in der Heftmitte)  
 n (Siehe Farbteil in der Heftmitte)  
 o (Siehe Farbteil in der Heftmitte)  
 p (Siehe Farbteil in der Heftmitte)  
 q (Siehe Farbteil in der Heftmitte)  
 r (Siehe Farbteil in der Heftmitte)  
 s (Siehe Farbteil in der Heftmitte)  
 t (Siehe Farbteil in der Heftmitte)  
 u (Siehe Farbteil in der Heftmitte)

Cl. 05-05 **131 069** 16.09.2004  
 4 Design – Gewebe (Textilien)  
 Hinterleger: Sonntex Freizeitprodukte GmbH,  
 Industriestrasse 20, Melsungen, DE  
 Designer: Sabine Ziegler, Gross-Gerau  
 Vertreter: Bovard AG, 3000 Bern 25  
 Priorität: EM, 19.03.2004  
 300423 - 1 (Siehe Farbteil in der Heftmitte)  
 300423 - 2 (Siehe Farbteil in der Heftmitte)  
 300423 - 3 (Siehe Farbteil in der Heftmitte)  
 300423 - 4 (Siehe Farbteil in der Heftmitte)

Cl. 06-01 **131 070** 09.09.2004  
 2 Design – Sitzmöbel  
 Hinterleger: MCA-Agentur Establishment, Industriestrasse 4,  
 Bendern-Gamprin, LI  
 Designer: Patrick Poltera, Bendern-Gamprin  
 Vertreter: Büchel, von Révy & Partner, Patentanwälte,  
 9500 Wil SG  
 K-D-50130-CH/1 (Siehe Farbteil in der Heftmitte)  
 K-D-50130-CH/2 (Siehe Farbteil in der Heftmitte)

Cl. 06-01 **131 071** 17.09.2004  
 2 Design – Stuhl, Hocker  
 Hinterleger: Patrick Urben, Sternengasse 23, Postfach 2154,  
 4001 Basel



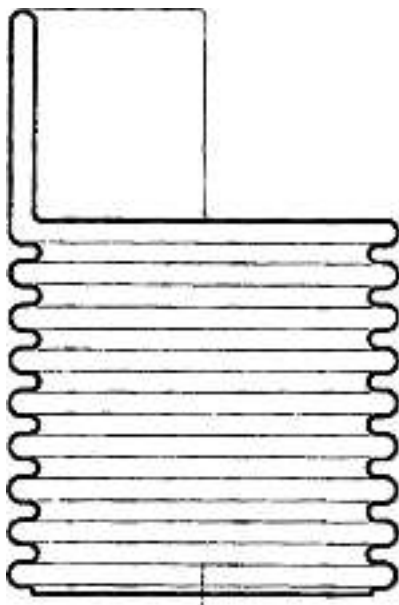
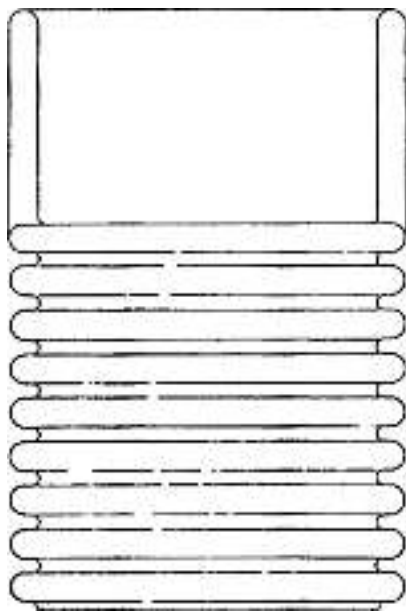
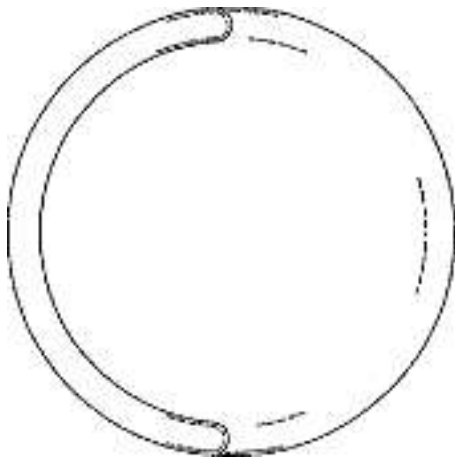

Pump-Stuhl

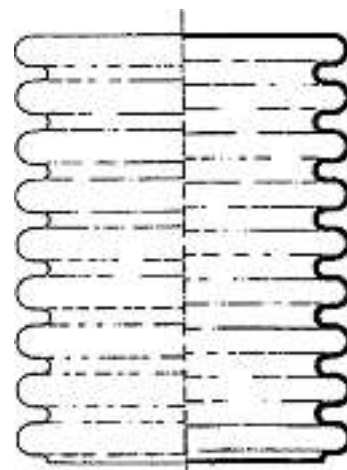
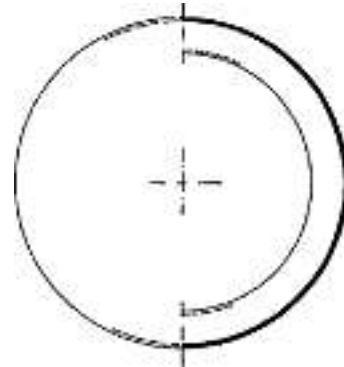
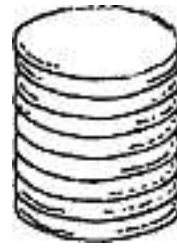

Pump-Hocker

Cl. 06-03 131 073 26.08.2004  
 1 Design – Tisch  
 Hinterleger: BrainStore AG, Aarbergstrasse 3-5, 2501 Biel  
 Designer: Markus Mettler, Biel



Tropfentisch

Cl. 06-03, 06-04 131 074 27.08.2004  
 3 Design – Tische und CD-Halter  
 Hinterleger: formanek.ch, Bürenweg 5/7, 4500 Solothurn  
 Designer: Marianne Formánek-Rufer, Solothurn;  
 Karel Formánek, Solothurn  
 Vertreter: Karel Formánek, 4500 Solothurn



04001



04002



04003

Cl. 06-03 131 075 23.09.2004  
 2 Design – Tische  
 Hinterleger: Roland Brunner, Seebaldematt 24,  
 6018 Buttisholz; Bruno Egli, Oberbueche, 6026 Rain  
 Vertreter: Roland Brunner, 6018 Buttisholz



001





002

Cl. 06-04      **131 076**      01.10.2004  
 33 Design – Schuhständer und Teile davon  
 Hinterleger: CSA Michael Furtner, Bahnhofstrasse 13,  
 6780 Schruns, AT  
 Designer: Hermann Thaler, Schruns  
 Vertreter: Isler & Pedrazzini AG, 8023 Zürich  
 Priorität: EM, 08.04.2004

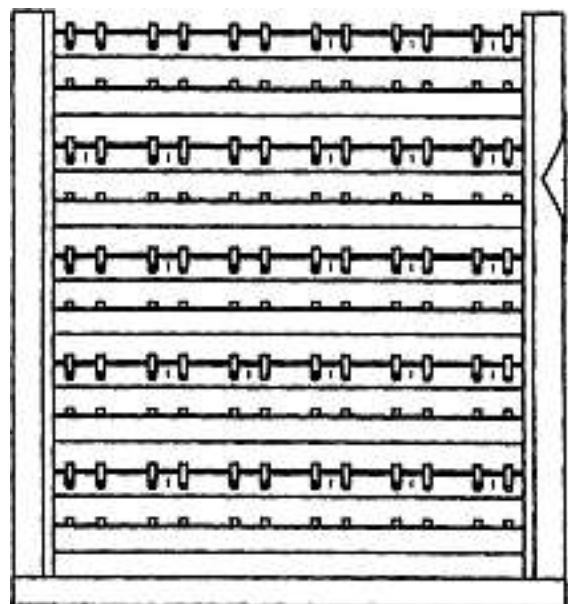
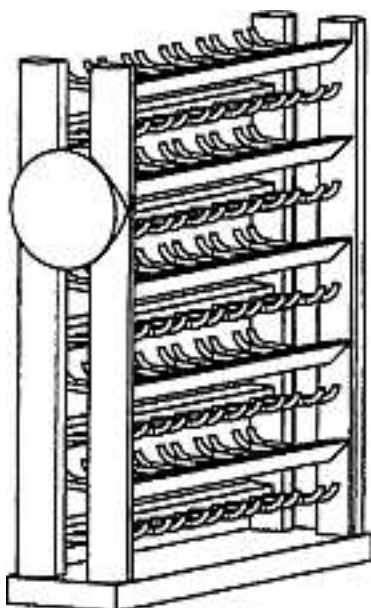
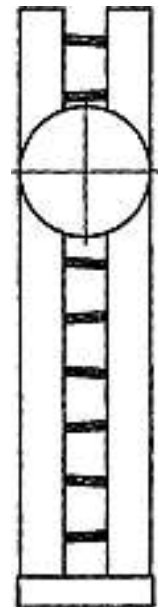
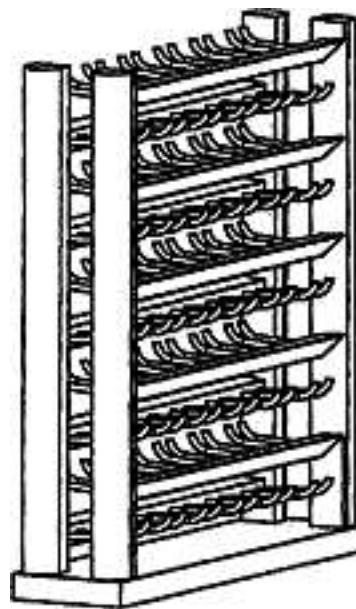
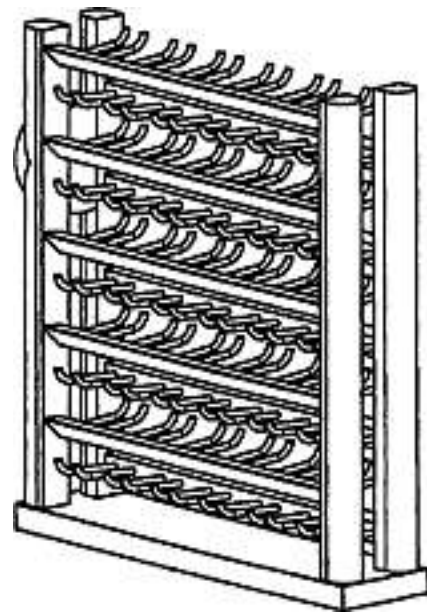



1

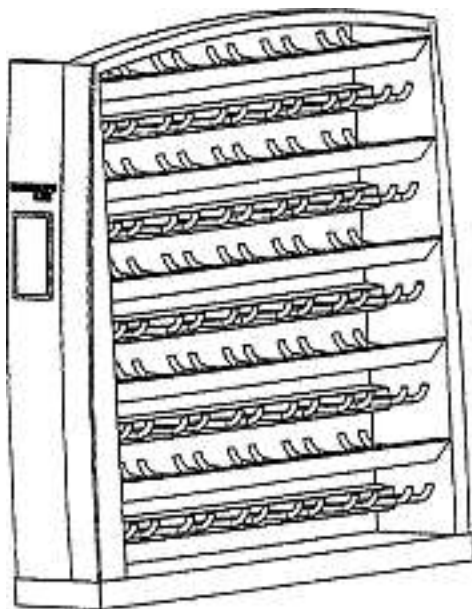
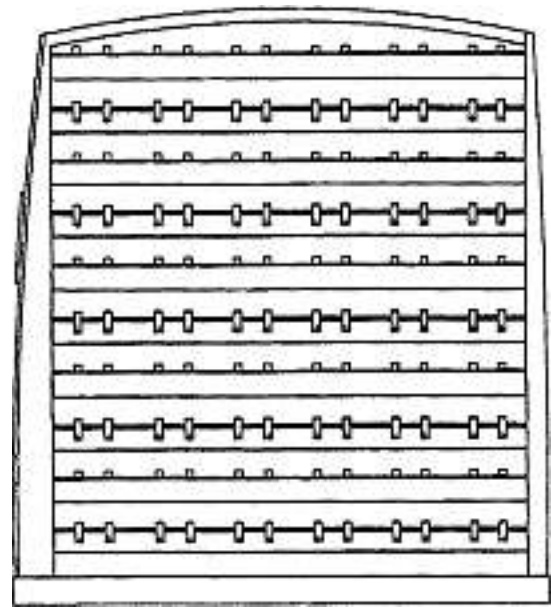

2

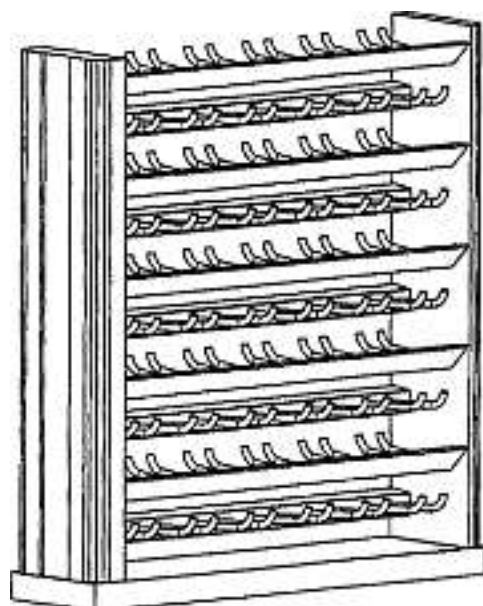
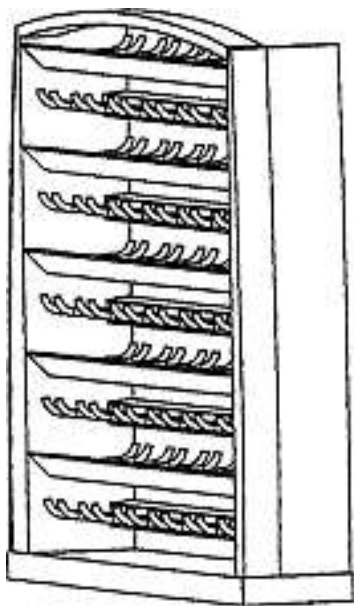

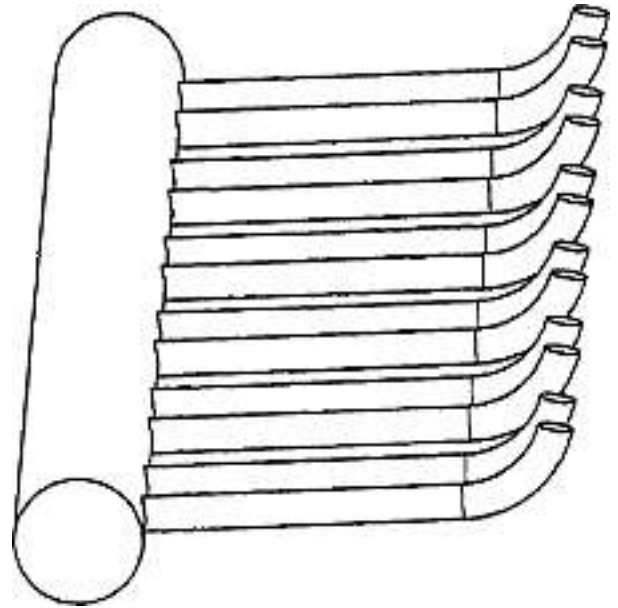
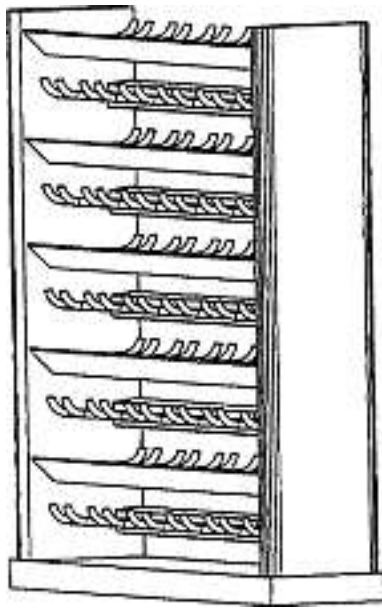

4

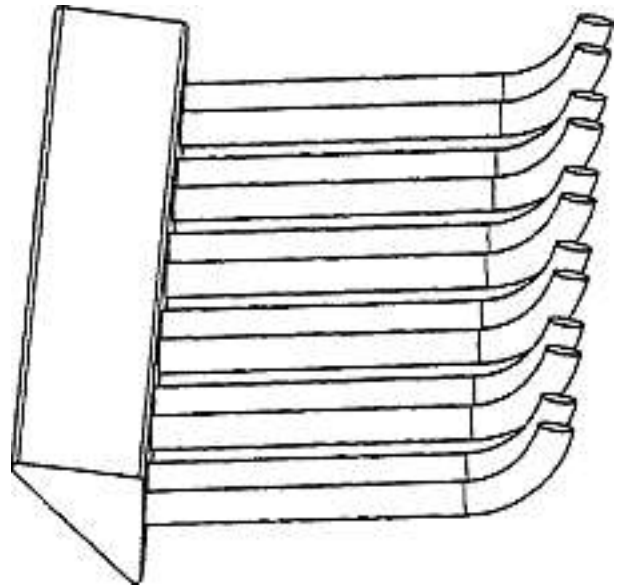
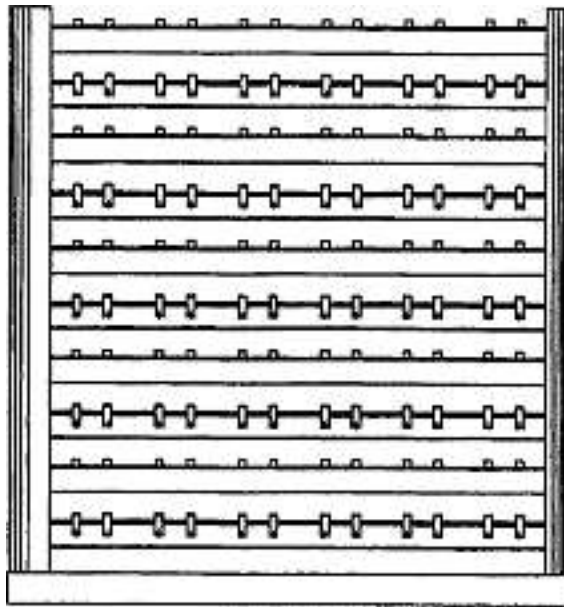

5



3

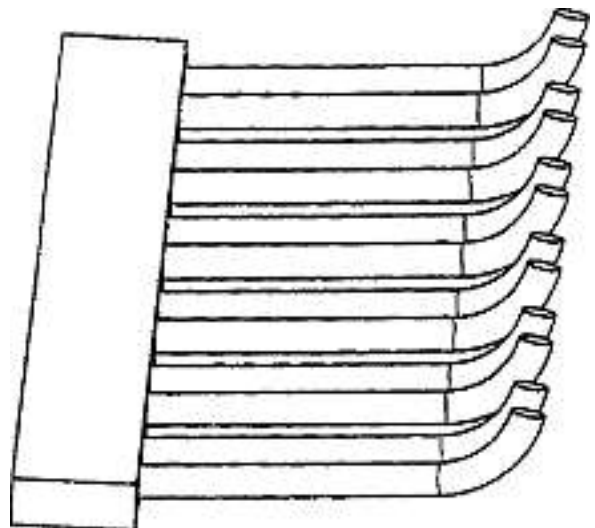

6

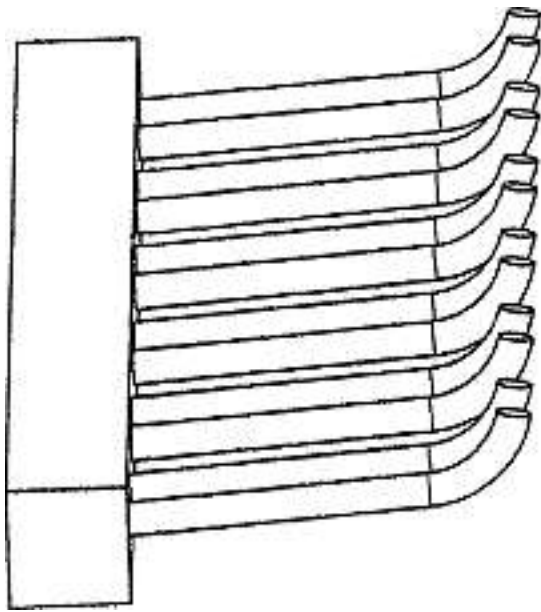

7

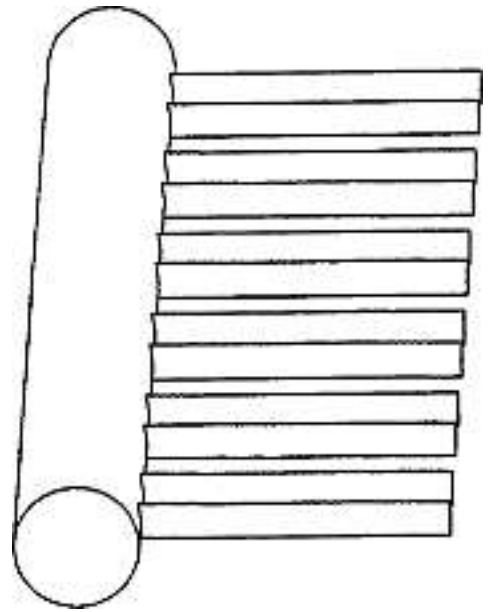

10

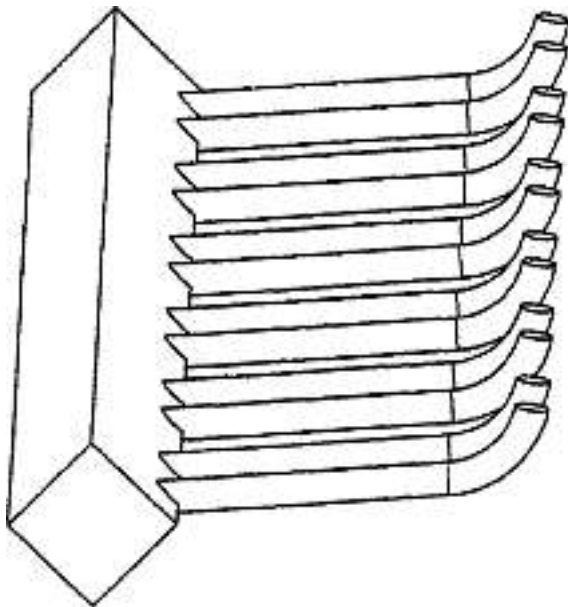

8

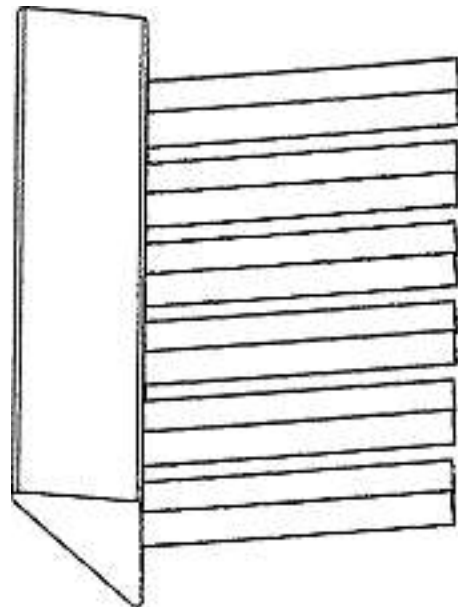

11

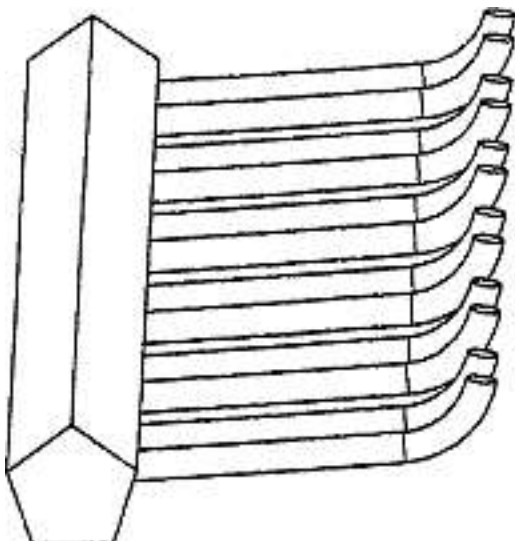

9

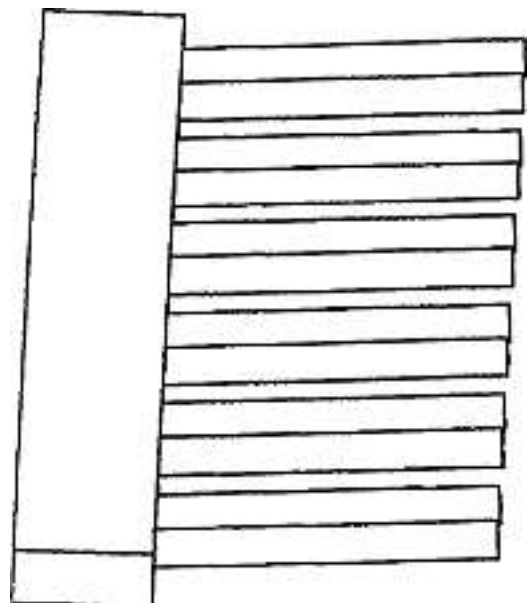

12

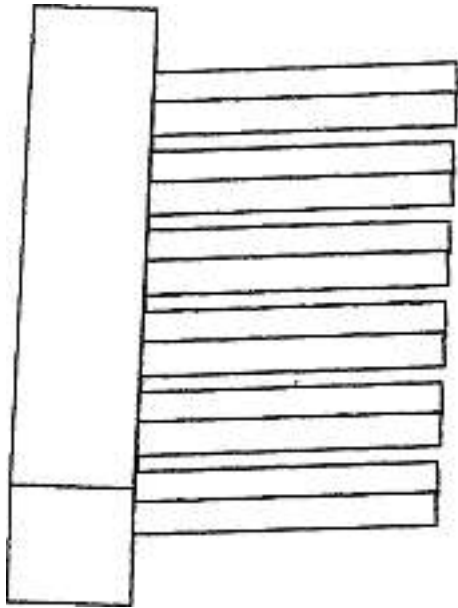

13

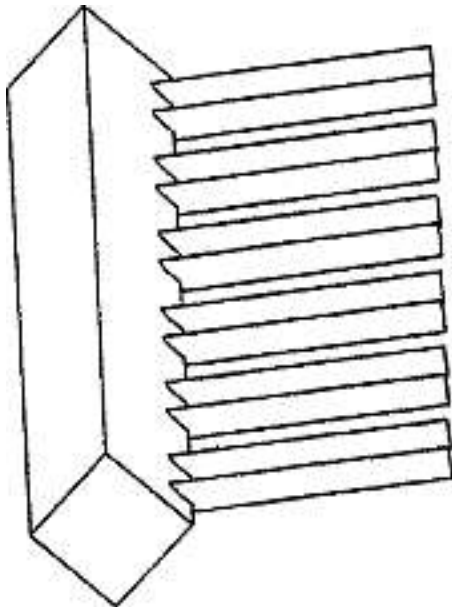

14

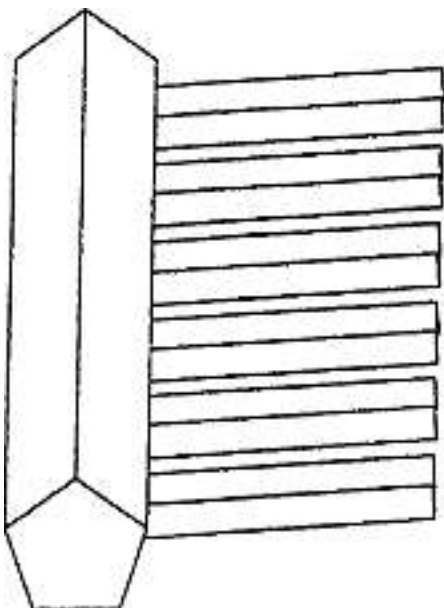

15

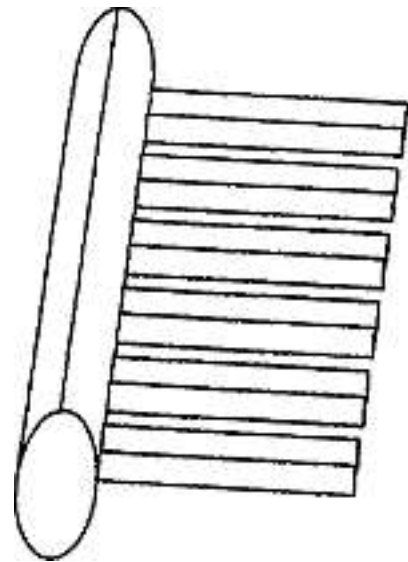

16

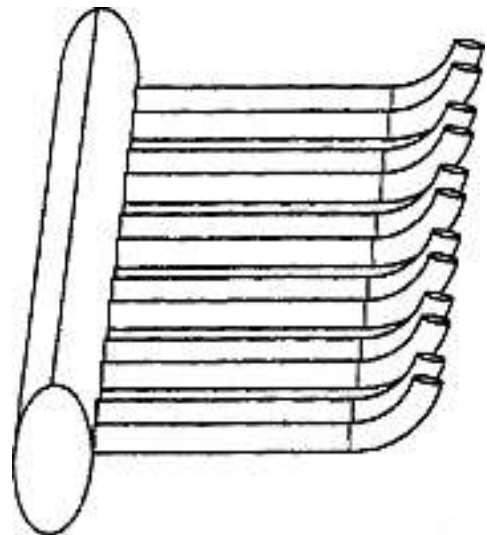

17

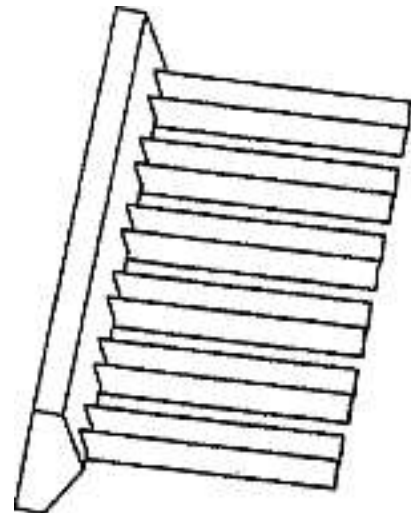

18

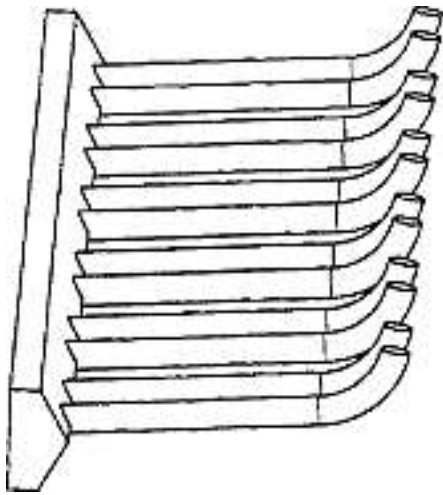

19

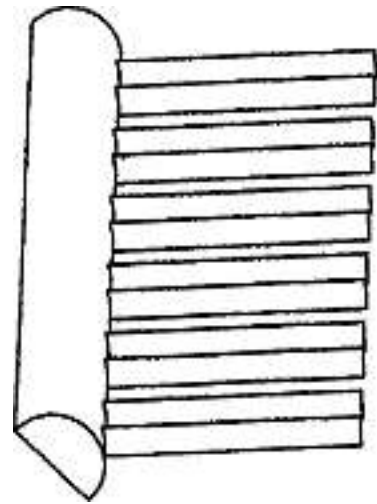

22

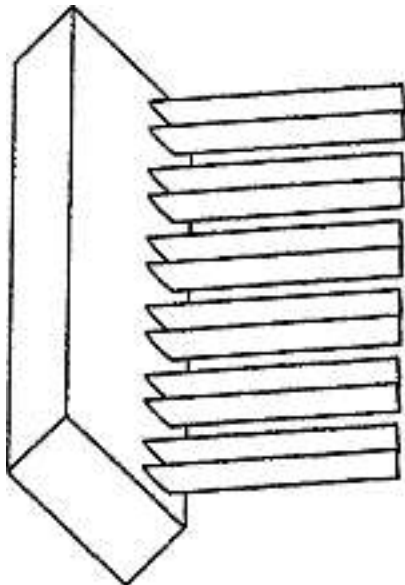

20

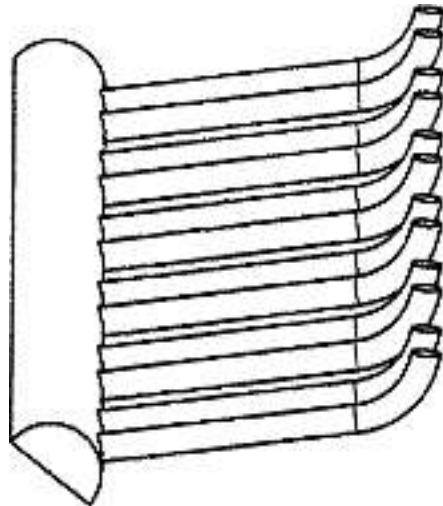

23

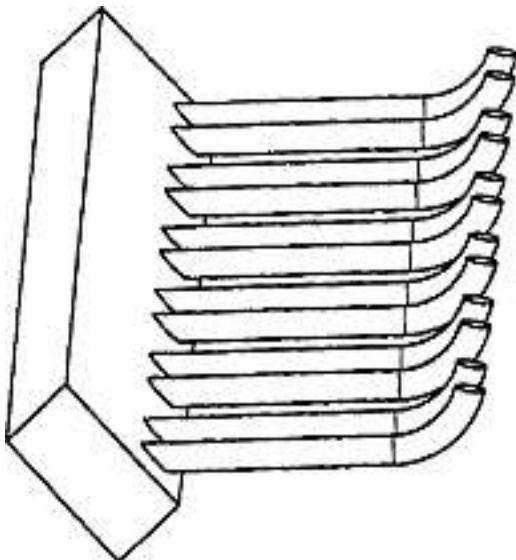

21

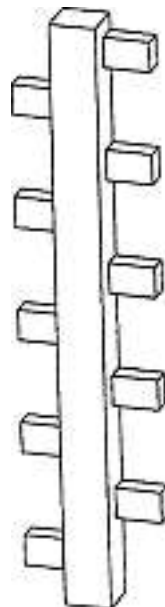

24

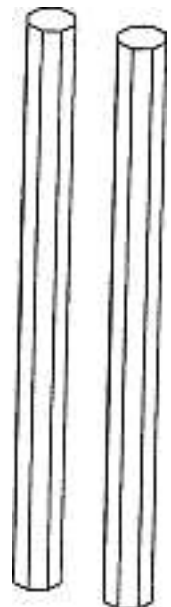

25

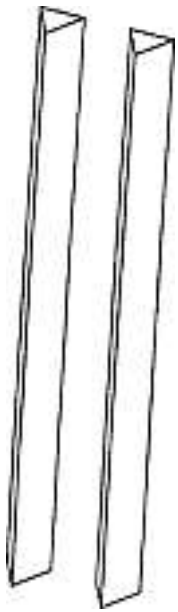

26

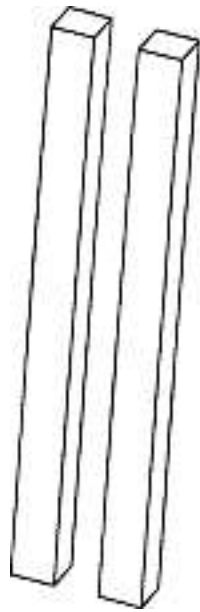

27



32

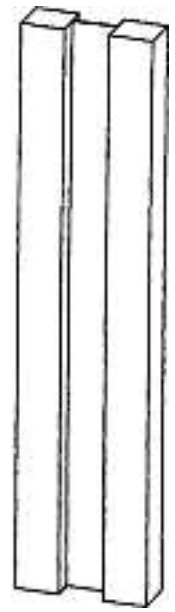

33

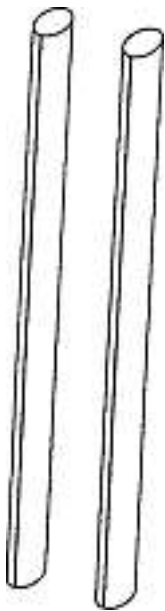

28



29



30



31

Cl. 06-07 131 077 22.09.2004  
2 Design – Bilderrahmen  
Hinterleger: Patrizia Haller, Feldeggstrasse 54, 8008 Zürich

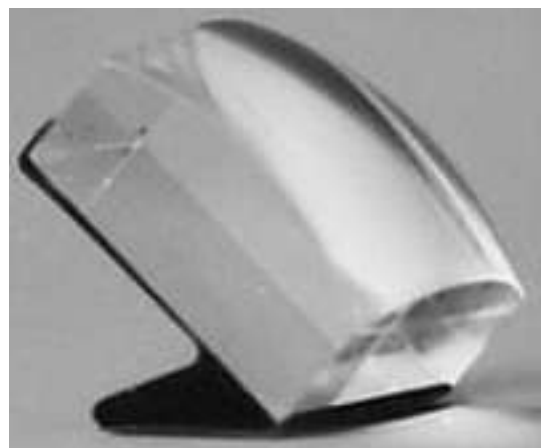

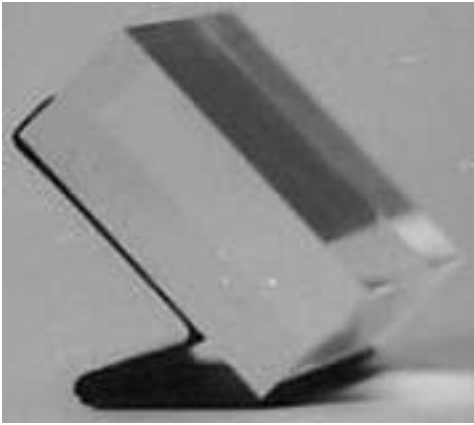

blow up



1



swimming pool

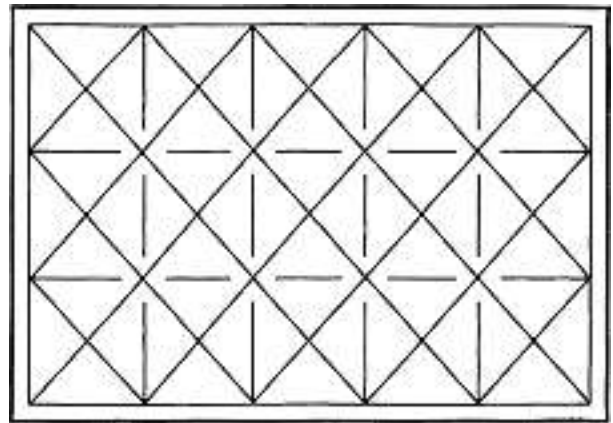

2

Cl. 06-13                      **131 078**                      09.09.2004  
23 Design – Absteppungen für Bettwaren  
Hinterleger: Thermobalance AG, Kaltenbacherstrasse 24,  
8260 Stein am Rhein  
Designer: Daniel Bernegger, Herisau  
Vertreter: Frei Patentanwaltsbüro AG, 8029 Zürich

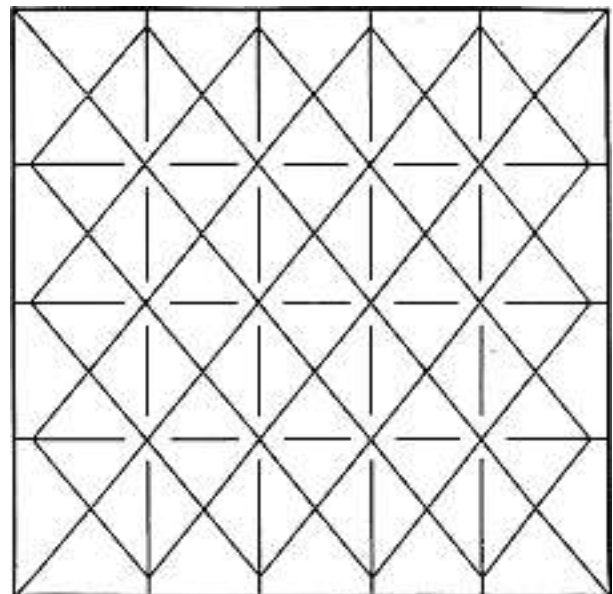
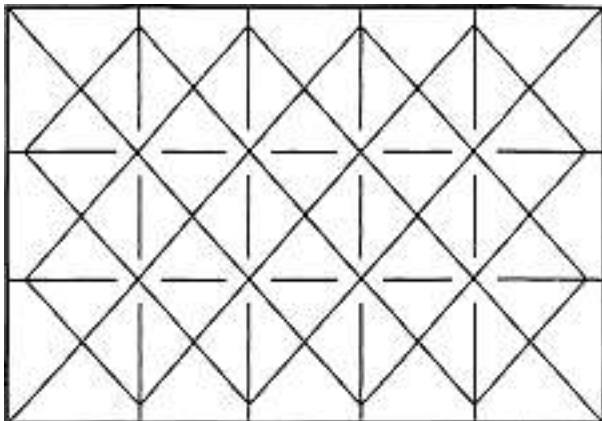

3



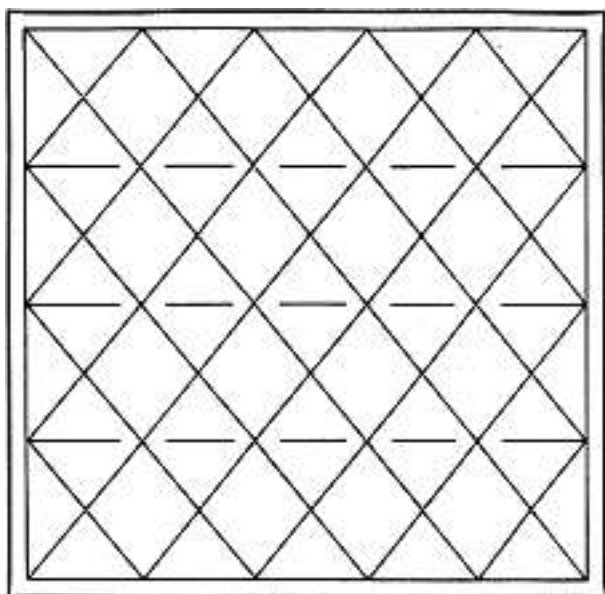

4



6

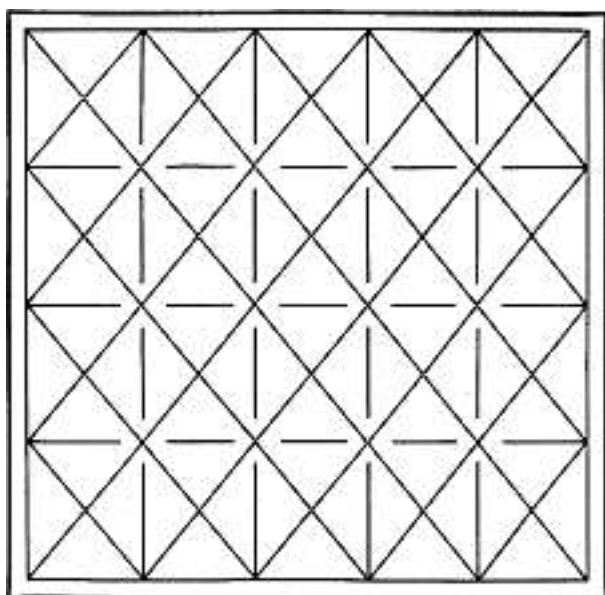

5

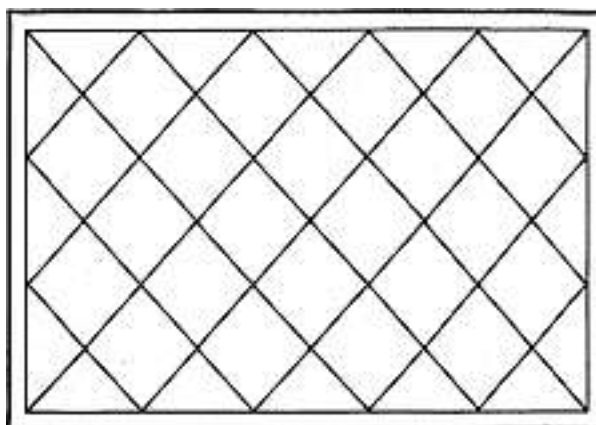

7

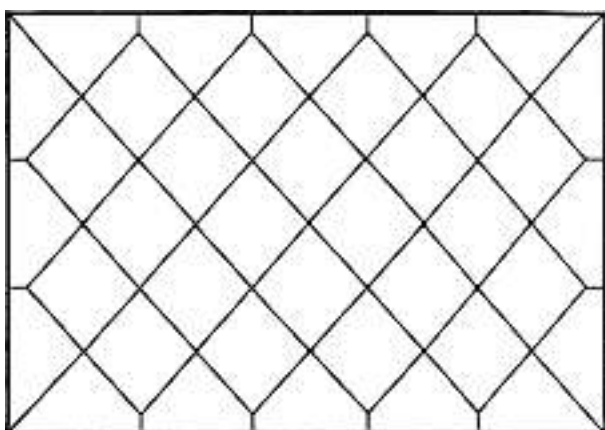

8

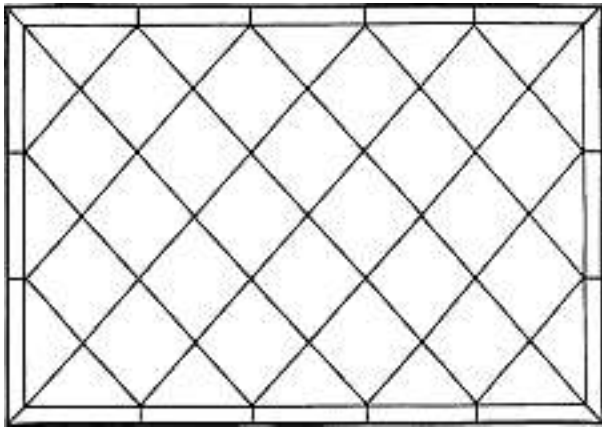

9

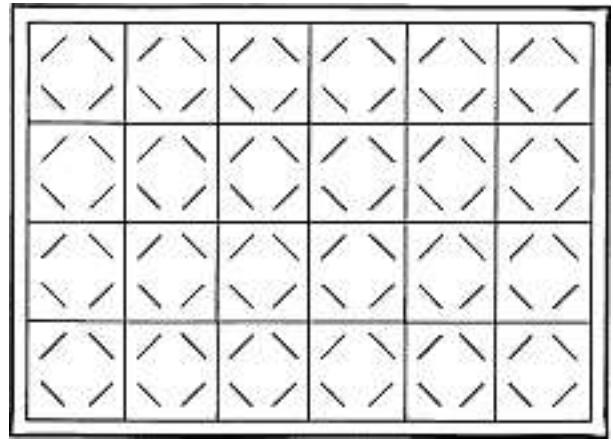

12

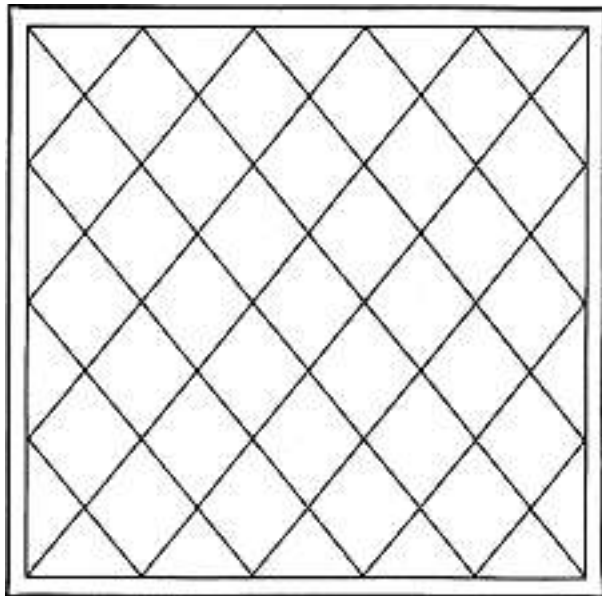

10

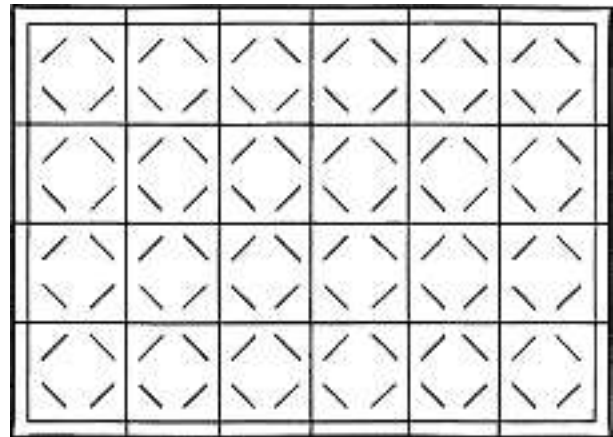

13

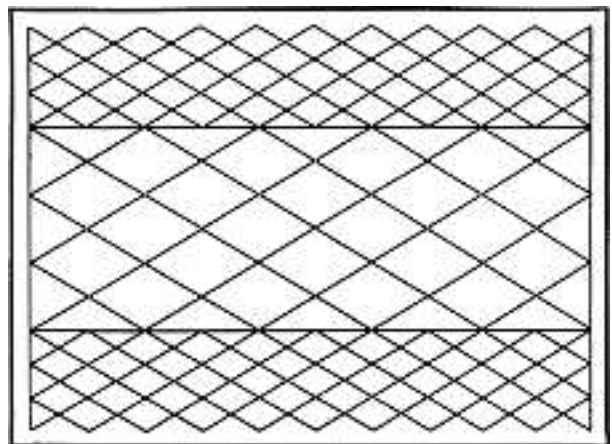

14

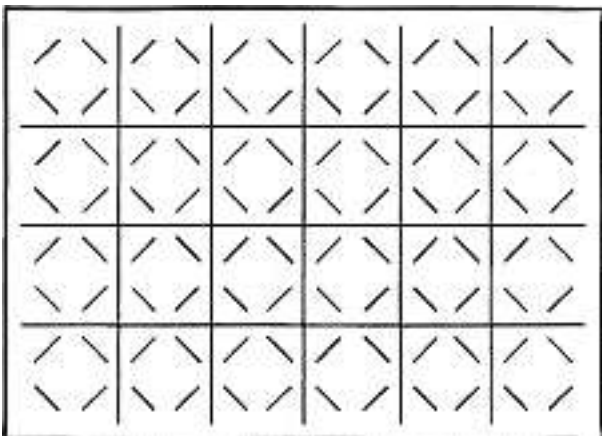

11

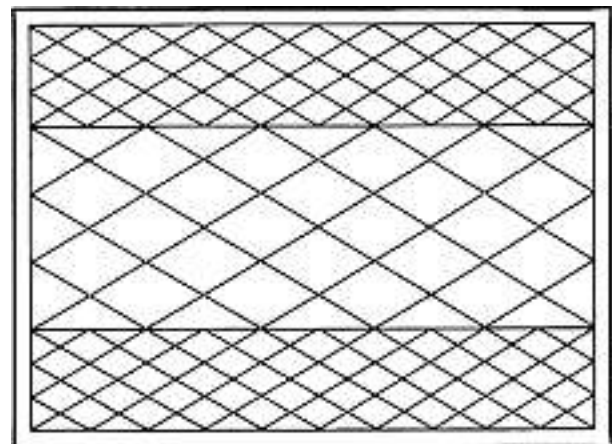

15

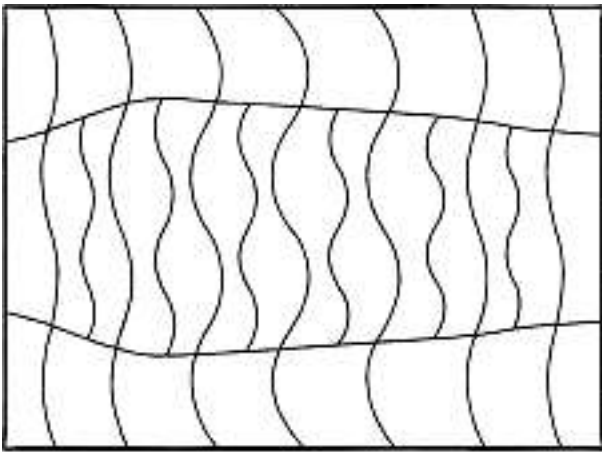

16

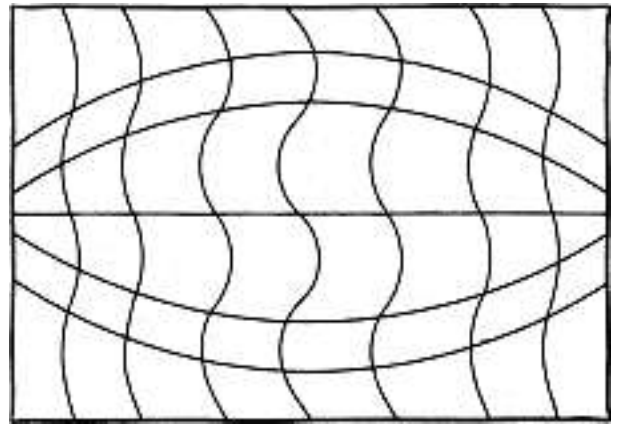

20

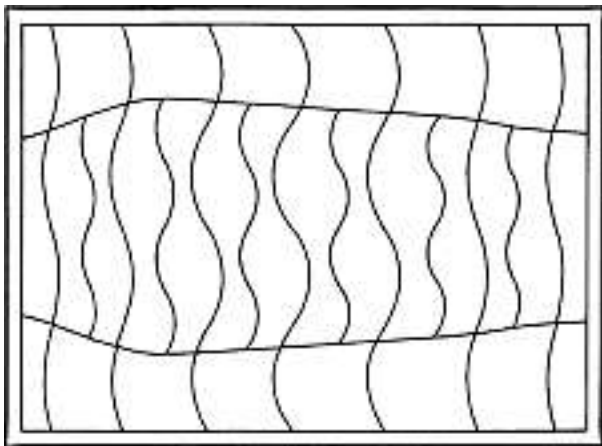

17

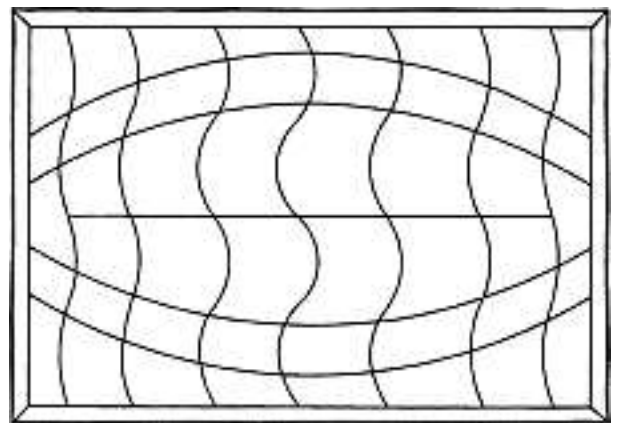

21

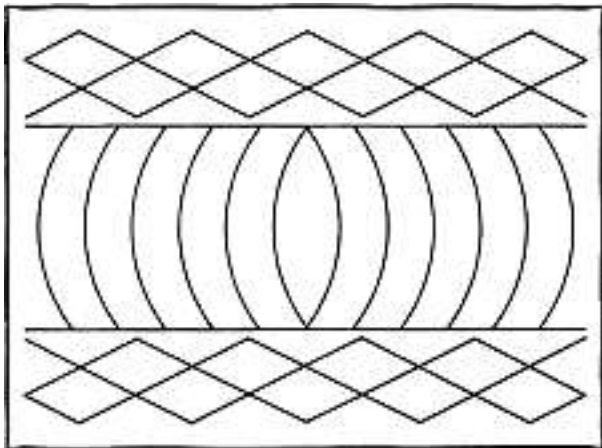

18

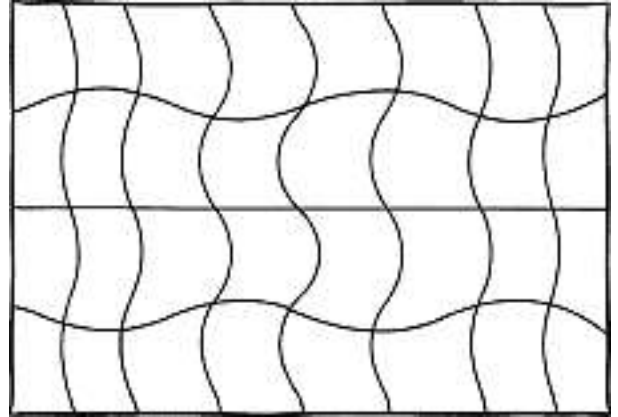

22

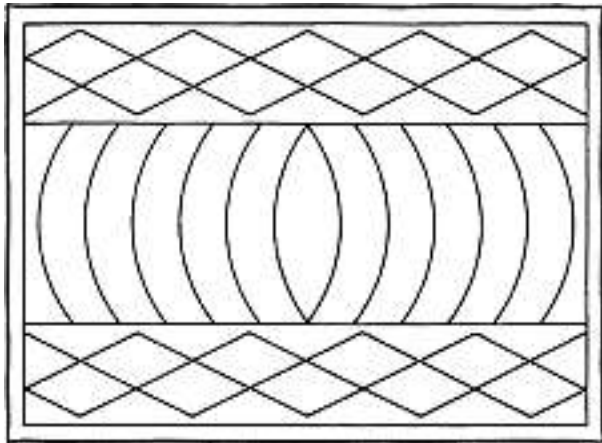

19

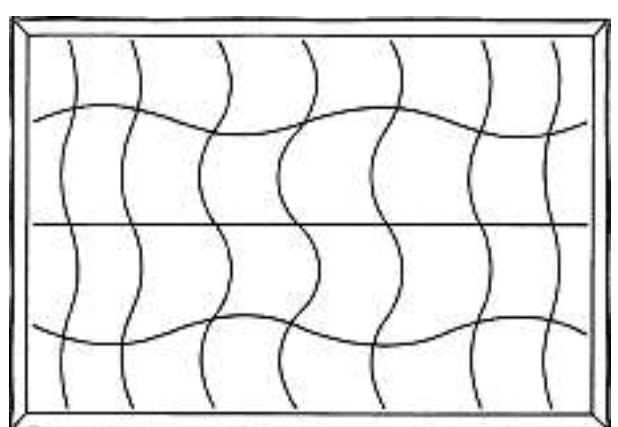

23

Cl. 06-13 131 079 28.09.2004  
 1 Design – Fix-Schlafdecke  
 Hinterleger: Flurina Vitali, Gäuggelistrasse 49, 7000 Chur

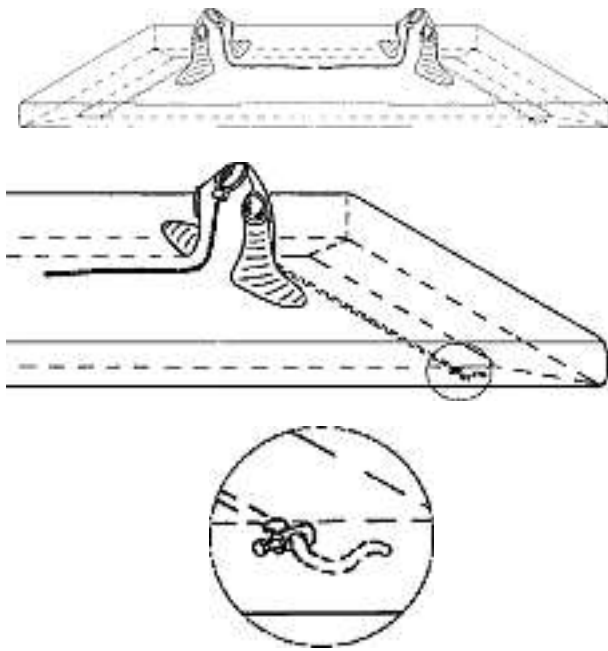

1

Cl. 07-06 131 081 16.09.2004  
 1 Design – Küchen-Zange  
 Hinterleger: Wietlisbach Industries, Ringweg 2, 5504 Othmarsingen  
 Designer: Beat Wietlisbach, Othmarsingen

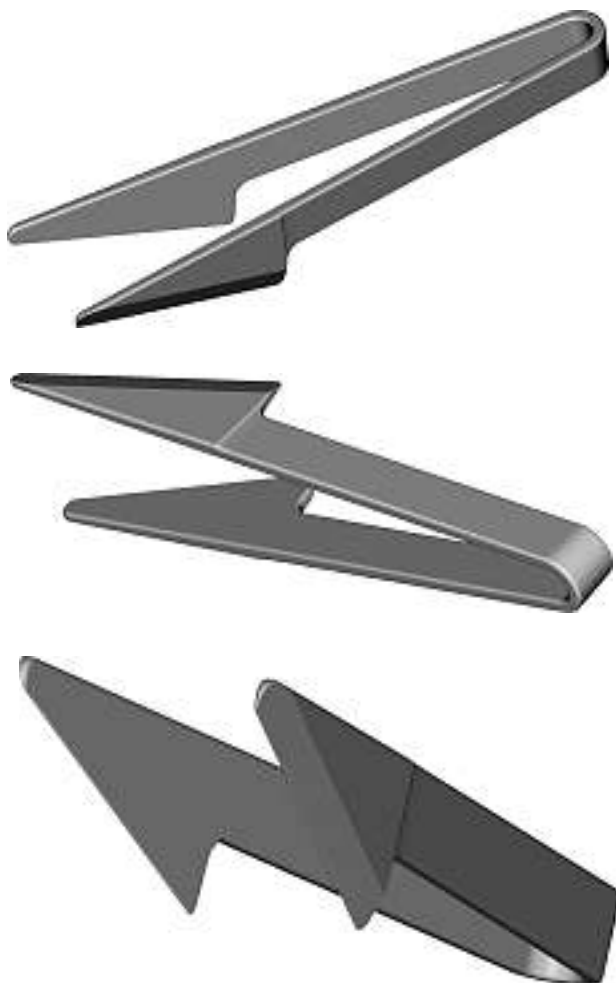

150904001

Cl. 08-99 131 083 15.09.2004  
 4 Design – Gitter  
 Hinterleger: Silvio Köng, Schoopacker 24, 8225 Siblingen;  
 Norbert Meier, Scheuermattweg 32, 4497 Rünenberg  
 Vertreter: Industrieberatung Maier AG, 4450 Sissach

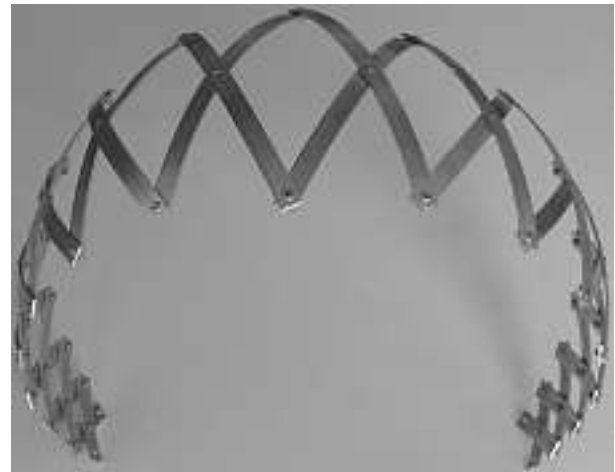

1



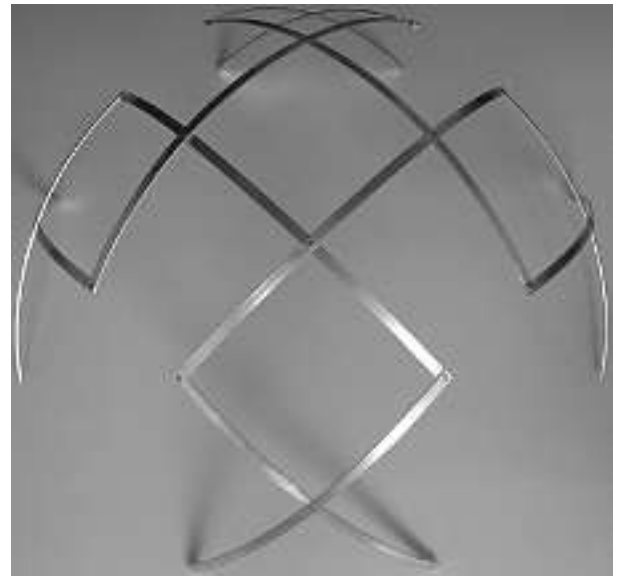
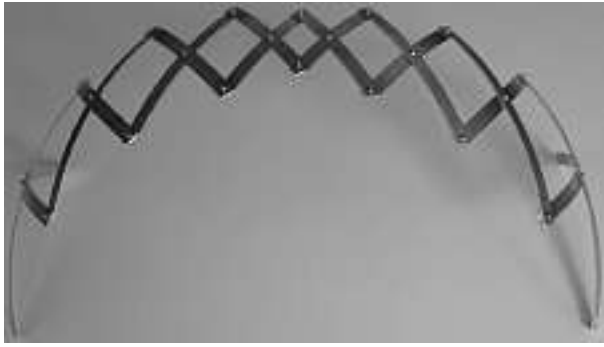

2

3

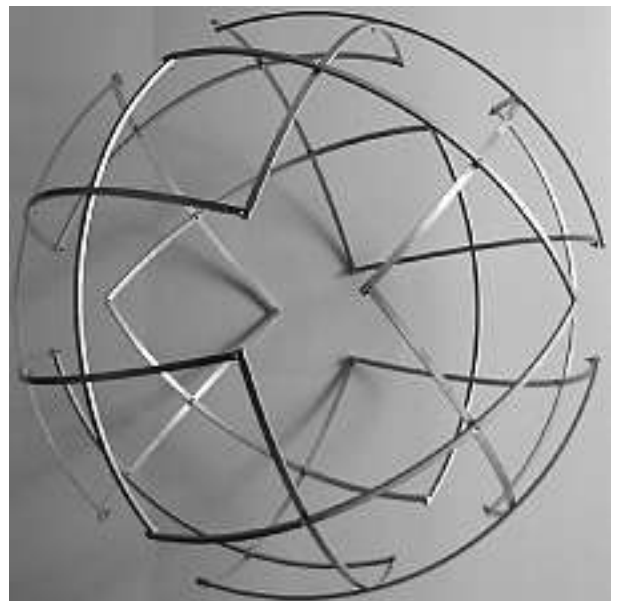

4

Cl. 09-01 131 084 26.08.2004  
 1 Design – Flasche  
 Hinterleger: Barry Callebaut Schweiz AG, Neugutstrasse 58,  
 8600 Dübendorf  
 Designer: Thomas Thomann, Wallbach



158098

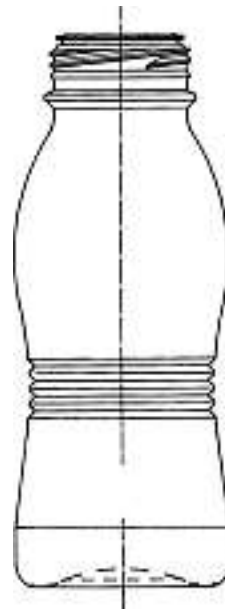

Cl. 09-01 131 086 07.10.2004  
 10 Design – Behälter  
 Hinterleger: Nussbaum Matzingen AG,  
 Frauenfelderstrasse 67, 9548 Matzingen  
 Designer: Andreas Germann, Scherzingen  
 Vertreter: Frei Patentanwaltsbüro, 8029 Zürich

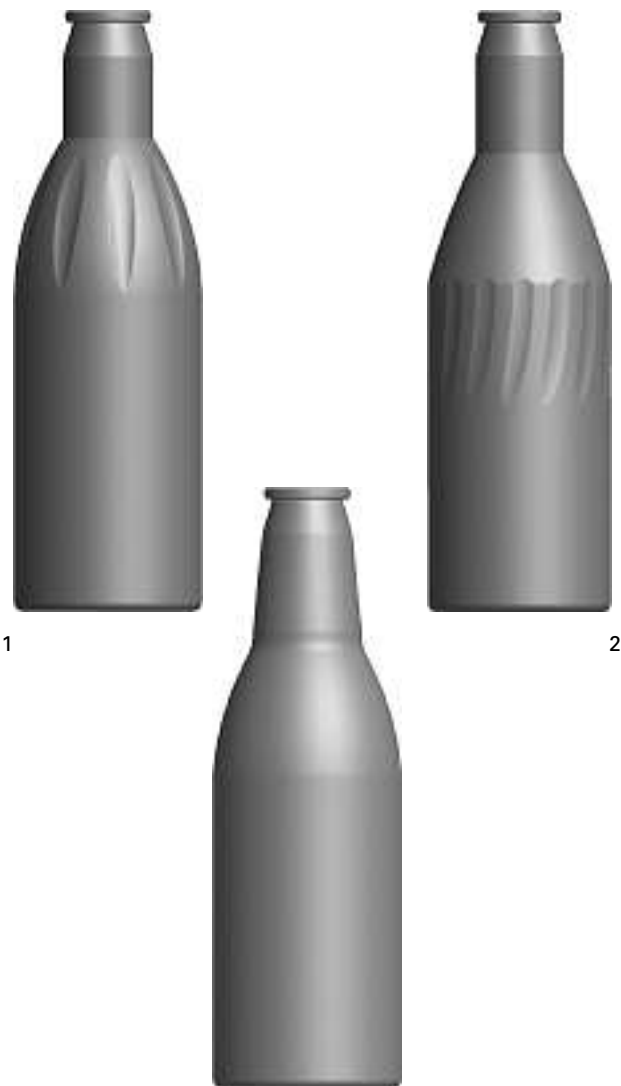

1

2

3

135.0850.00

Cl. 09-01 131 085 24.09.2004  
 3 Design – Flaschen  
 Hinterleger: AZM Aargauer Zentralmolkerei AG,  
 Obertelweg 2, 5034 Suhr  
 Designer: Robert Maerky, Winkel

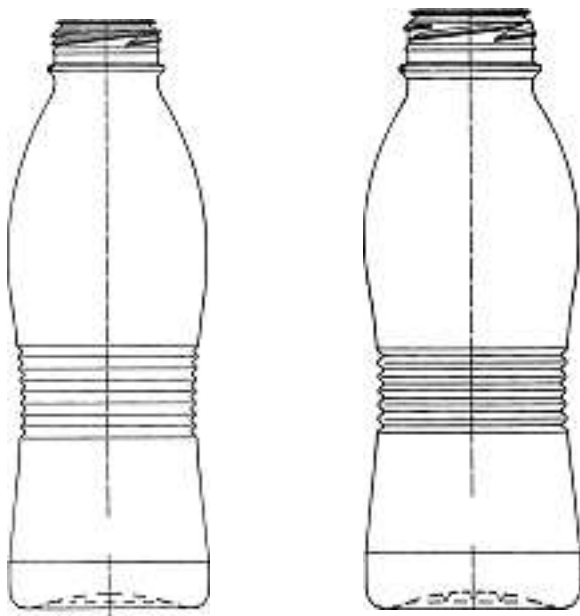

158106

157314



4



5



6



7



8



9



10

Cl. 09-07 131 087 26.08.2004  
1 Design – Flaschenverschluss  
Hinterleger: Barry Callebaut Schweiz AG, Neugutstrasse 58,  
8600 Dübendorf  
Designer: Thomas Thomann, Wallbach



310.0850.00

Cl. 10-03 131 088 22.09.2004  
 1 Design – Anhänger-Sonnenuhr  
 Hinterleger: Meister + Co AG, Hauptstrasse 66, 8832 Wollerau  
 Designer: Silvio Daldini, Kilchberg ZH; Thomas Geiser, Wollerau; Dieter Flehmer, Unteriberg; Marcus Siessegger, Wollerau



Nr. 1



Bracelet 101

Cl. 10-04 131 089 29.09.2004  
 1 Design – Mautgerät  
 Hinterleger: Siemens Aktiengesellschaft, Wittelsbacherplatz 2, München, DE  
 Designer: Ulrich Kraus, Villingen-Schwenningen  
 Vertreter: Siemens Schweiz AG, 8047 Zürich  
 Priorität: DE, 21.04.2004



2004M06416CH



Cl. 11-01 131 090 14.10.2004  
 5 Design – Armband (Schmuck)  
 Hinterleger: Ronzani & Ronzani, Hammerstrasse 58, 8032 Zürich  
 Designer: Caroline Ronzani, Zürich  
 Vertreter: Daniel Ronzani, 8032 Zürich





Bracelet 102



Bracelet 104



Bracelet 103





Bracelet 105

Cl. 14-04 **131 091** 21.09.2004

5 Design – Bildschirmelemente

Hinterleger: Tecan Trading AG, Seestrasse 103,  
8708 Männedorf

Designer: Jürgen Edelmeyer, Wiesbaden; Dusko Katona  
Lukic, Wiesbaden

Vertreter: OK pat AG, 6300 Zug



1



2



3



4



5

Cl. 14-99 **131 092** 06.10.2004

1 Design – Auflage für Laptop

Hinterleger: Inotop AG, Zürcherstrasse 51,  
8317 Tagelswangen

Designer: Ernst Scherrer, Greifensee

Vertreter: Patentanwälte Feldmann & Partner AG,  
8152 Glattbrugg



1

Cl. 16-06 **131 093** 27.09.2004

2 design – visionneuse de pierre précieuse

Déposant: Gersan Establishment, Aeulestrasse 5,  
9490 Vaduz, LI

Designer: Maxwell Ralph Willis, Henley On Thames

Mandataire: Bugnion S.A., 1211 Genève 12 – Champel

Priorité: EM, 14.04.2004

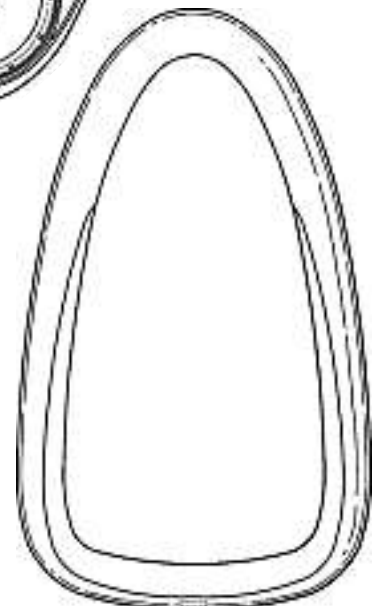

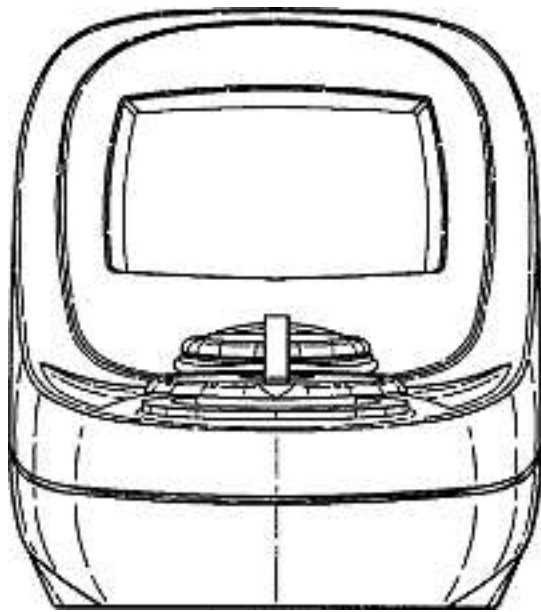

1

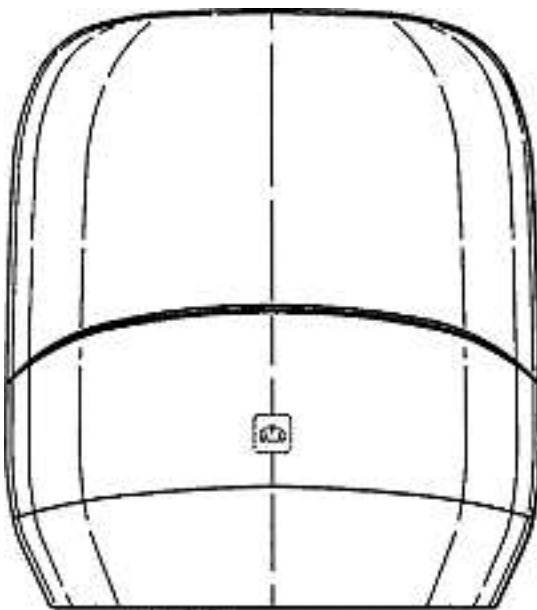

2

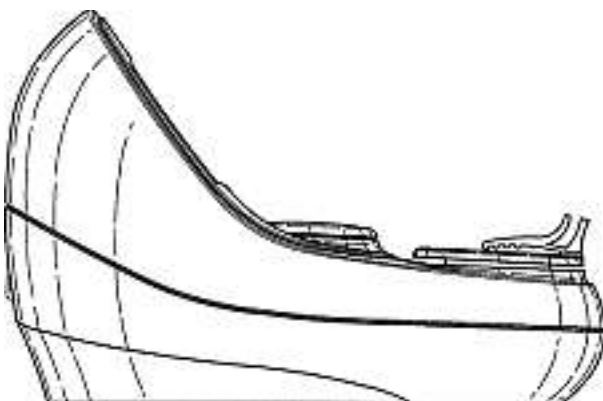

Cl. 16-06 **131 094** 30.09.2004  
 1 design – microscope à écran de visualisation  
 Déposant: Swift Instruments, Inc., 1190 N. Fourth Street,  
 San Jose, CA, US  
 Designer: David John Copeland, Milton; Aidan John Petrie,  
 Jamestown  
 Mandataire: Katzarov S.A., 1227 Genève  
 Priorité: US, 31.03.2004

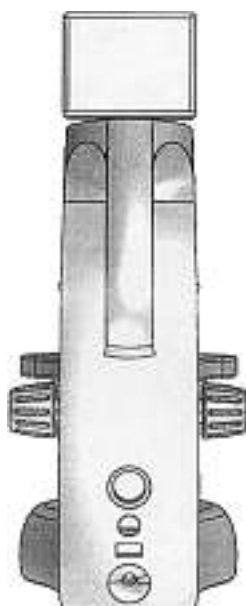
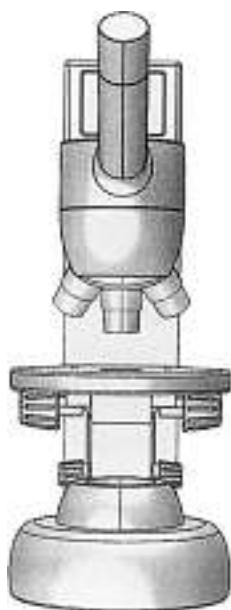
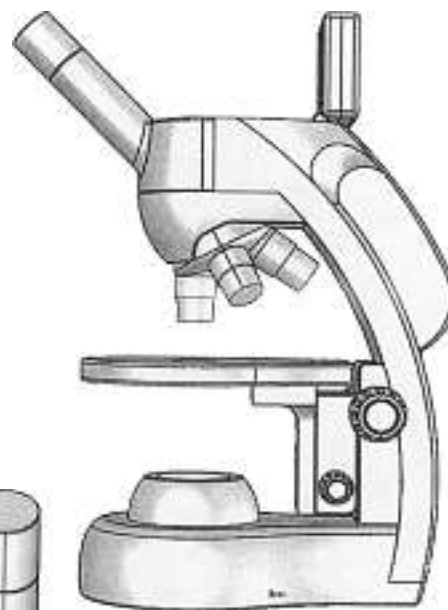
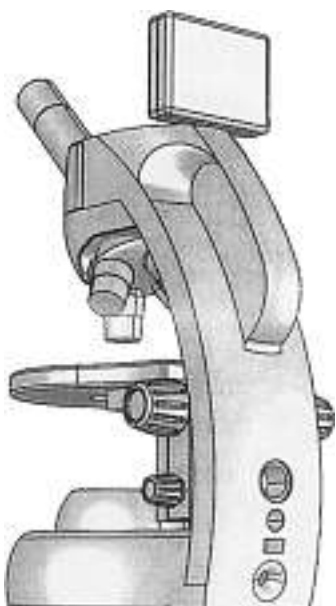

14791/CH

Cl. 19-06 **131 095** 24.09.2004

3 design - penne

Depositante: Guccio Gucci S.p.A., Via Tornabuoni, 73/R, 50123 Firenze, IT

Designer: Alessandro Fabrini, Roma

Mandatario: Jacobacci & Partners S.A., 1207 Genève

Priorità: EM, 29.03.2004

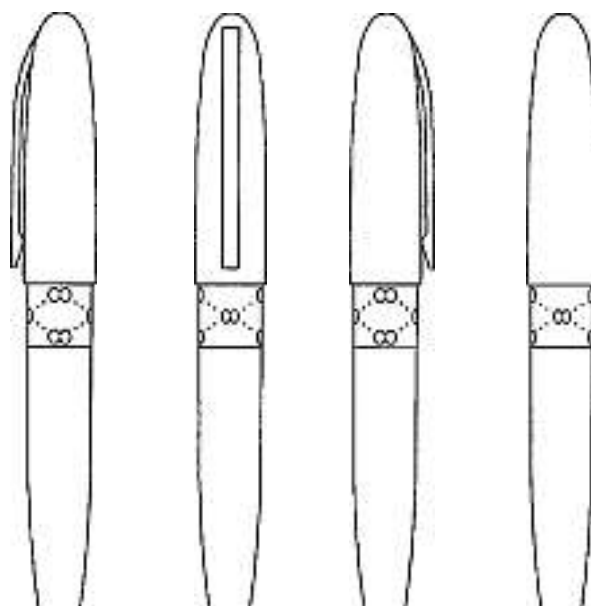



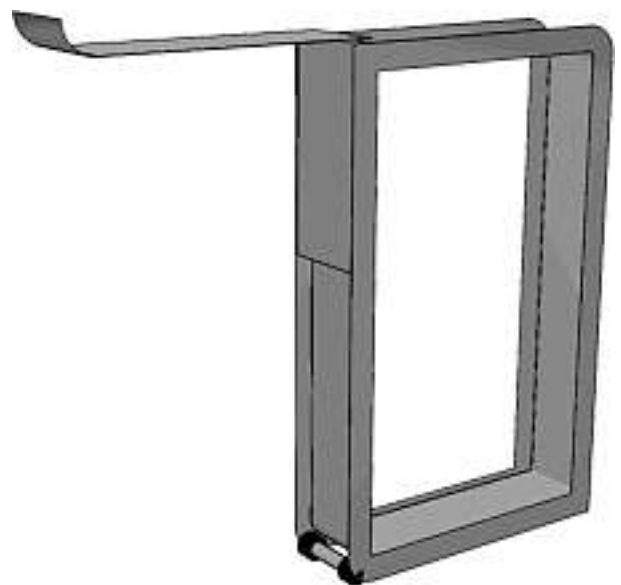
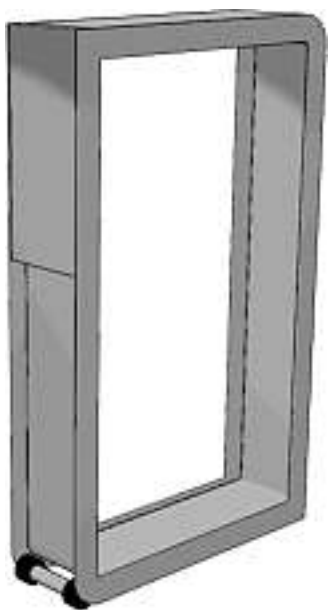
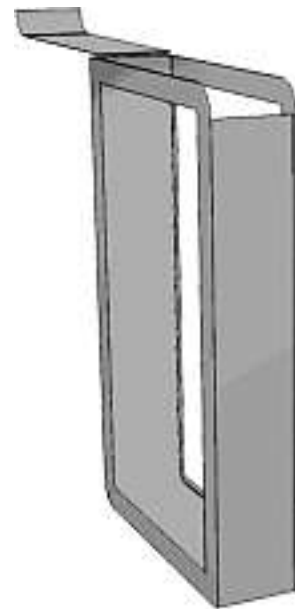
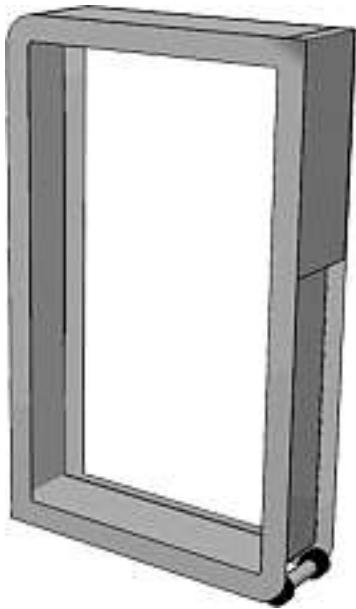
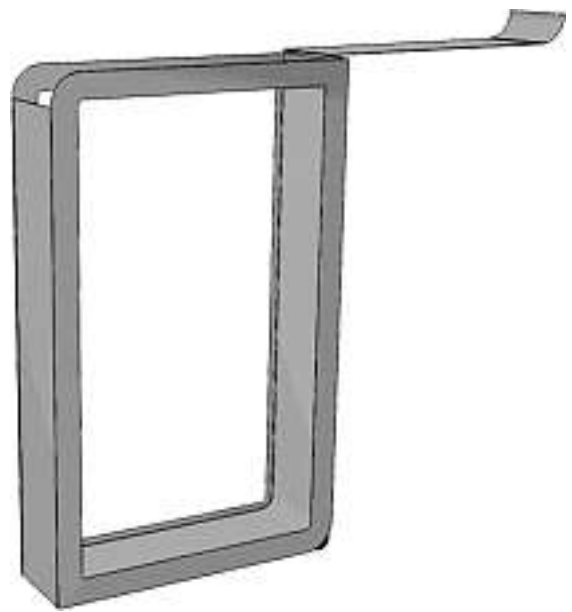
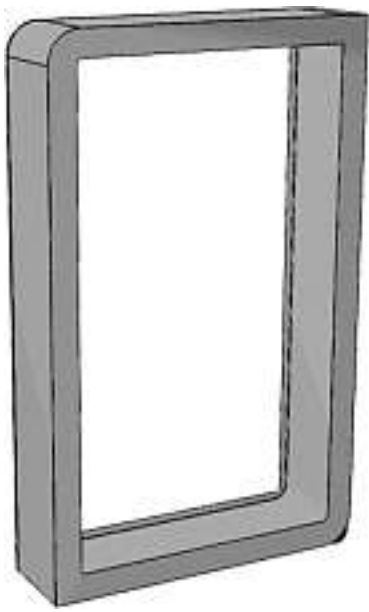

04320

Cl. 20-02 **131 097** 10.09.2004  
 3 Design – Präsentationseinrichtung  
 Hinterleger: Gust. Alberts GmbH & Co. KG, Gewerbegebiet  
 Grünenthal, 58849 Herscheid, DE  
 Designer: Dietrich Alberts, Herscheid  
 Vertreter: Büchel, von Révy & Partner, Patentanwälte,  
 9500 Wil SG  
 Priorität: DE, 06.05.2004  
 1 (Siehe Farbteil in der Heftmitte)  
 2 (Siehe Farbteil in der Heftmitte)  
 3 (Siehe Farbteil in der Heftmitte)

Cl. 21-01 **131 101** 23.09.2004  
 2 Design – Spiele  
 Hinterleger: Nimex AG, Räfelstrasse 11, 8045 Zürich  
 Designer: Warren Scott Fentress, Brookfield  
 Vertreter: Zimmerli, Wagner & Partner AG, 8001 Zürich  
 Beschreibung des Designs: Aus geometrischen Grundformen  
 gebildete magnetische Bausteine.  
 1 (Siehe Farbteil in der Heftmitte)  
 2 (Siehe Farbteil in der Heftmitte)

Cl. 21-01 **131 102** 27.09.2004  
 6 Design – Spielelemente  
 Hinterleger: Wilfried Grichting, Zum Wildbach,  
 3954 Leukerbad  
 Designer: Theodorus Suibertus Anthonius Rolf, Leukerbad  
 Vertreter: Ammann Patentanwälte AG Bern, 3001 Bern

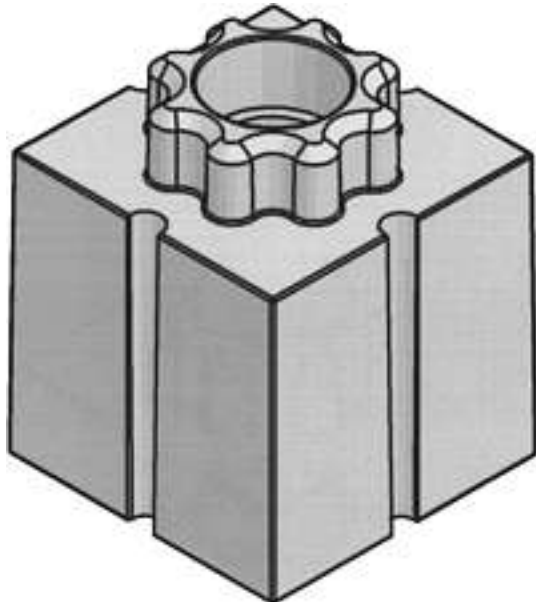

1

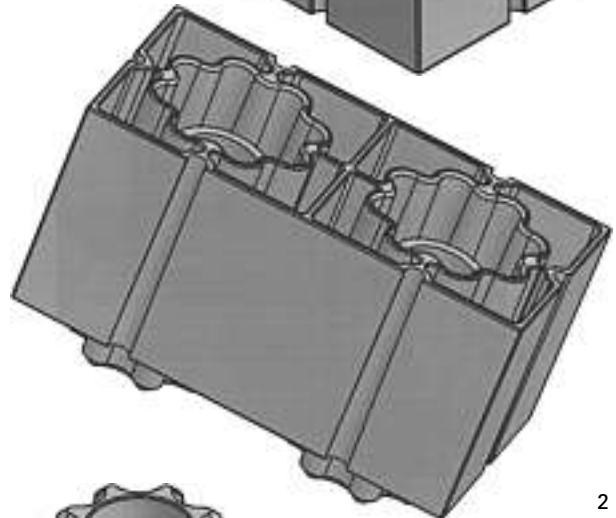
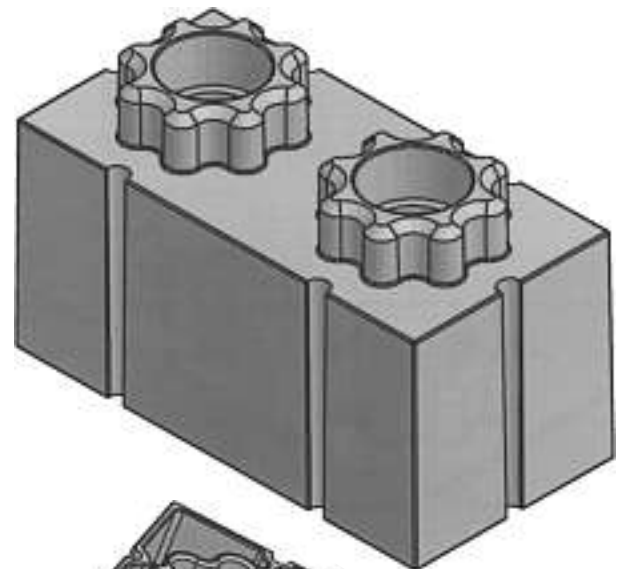

2

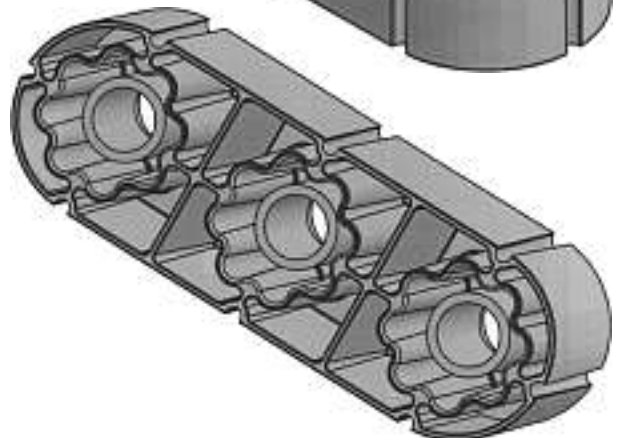
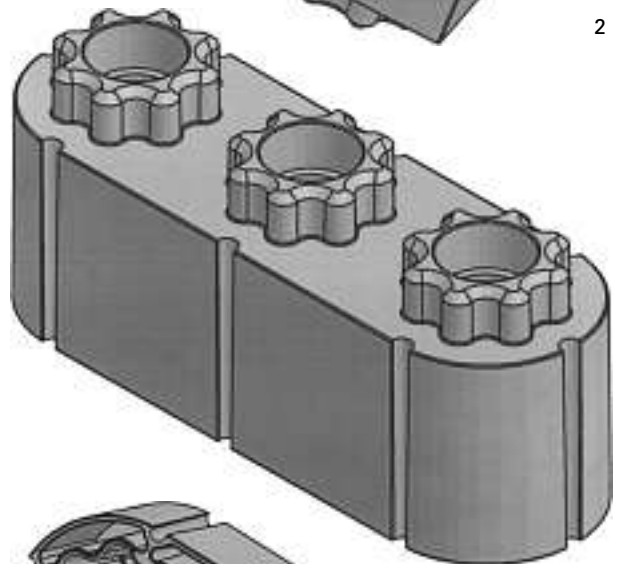

3

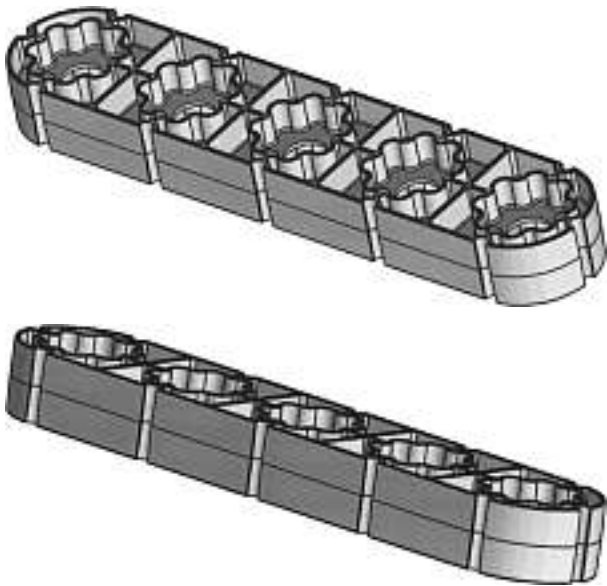

4



5



6

Cl. 21-01 **131 103** 13.10.2004

4 design – mascottes

Déposant: NOVAE HOLDING SA, c/o Anagest SA,  
Route de Moncor 2, 1752 Villars-sur-Glâne

Designer: David Haefeli, Vevey

Mandataire: Inteltech SA, 2001 Neuchâtel

1 (Siehe Farbteil in der Heftmitte)

2 (Siehe Farbteil in der Heftmitte)

3 (Siehe Farbteil in der Heftmitte)

4 (Siehe Farbteil in der Heftmitte)

Cl. 25-03 **131 104** 17.09.2004

2 Design – Briefkastenhalterungen

Hinterleger: Theodor Meier, Lächlerstrasse 39,  
8634 Hombrechtikon





rechteck



rund

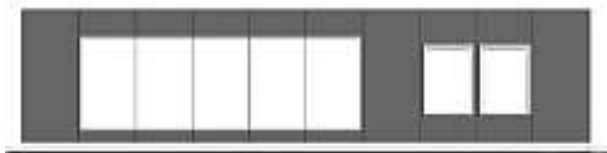
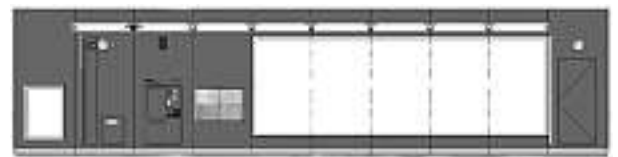

1

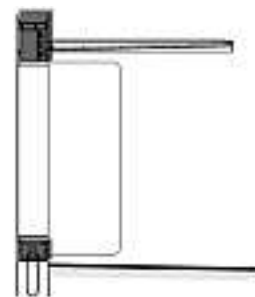

2



3

Cl. 25-03      **131 105**      23.09.2004  
 4 Design – Haltestellen und Module für Haltestellen  
 Hinterleger: Kai Flender, Berghausstrasse 2, Uhlingen, DE  
 Vertreter: Patentanwälte Feldmann & Partner AG,  
 8152 Glattbrugg



4



Cl. 26-01 131 106 16.09.2004  
 1 design – photophore  
 Déposant: Sonia Biétry, rue Mathurin-Cordier 9, 1005 Lausanne; Yves Morel, rue de la Comtesse 9, Marchaux, FR  
 Mandataire: Sonia Biétry, 1005 Lausanne



Tone 3

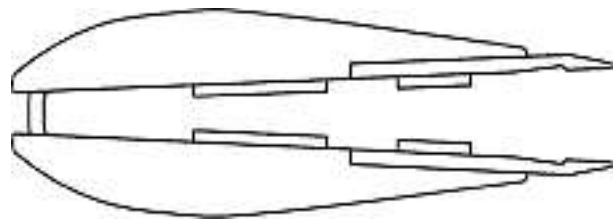

1

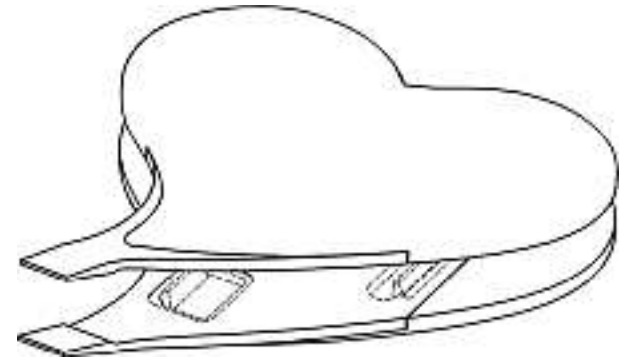

Cl. 28-03 131 107 23.09.2004  
 11 design – pinces et accessoires cosmétiques  
 Déposant: Swittools SA, Rue Théodore Dumont 1b, 2924 Montignez  
 Designer: Nicole Sgobero, Montignez  
 Mandataire: Patents & Technology Surveys SA, 2001 Neuchâtel

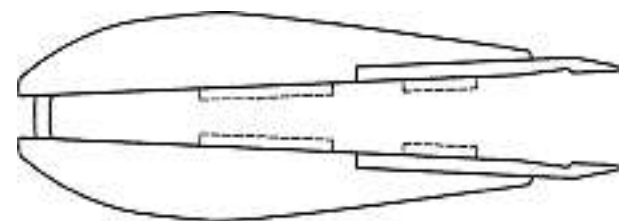
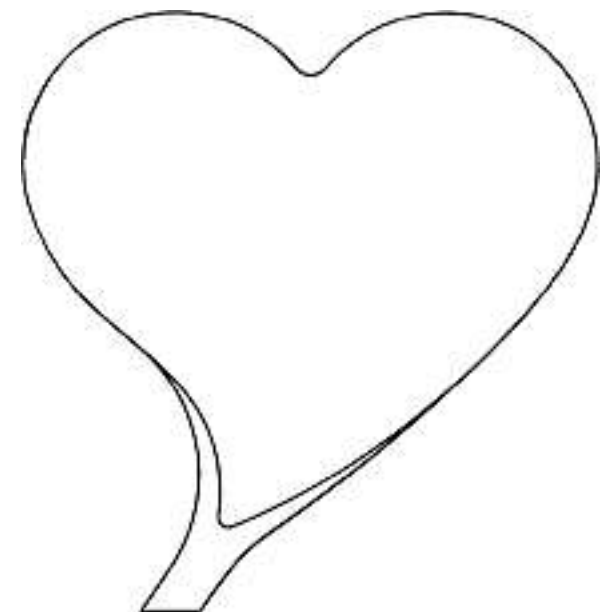
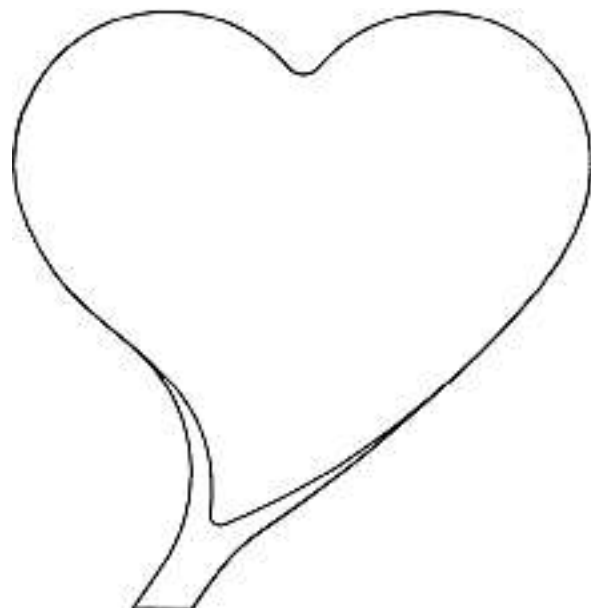
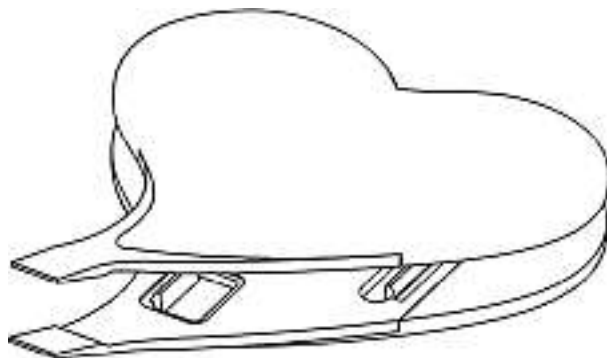

2

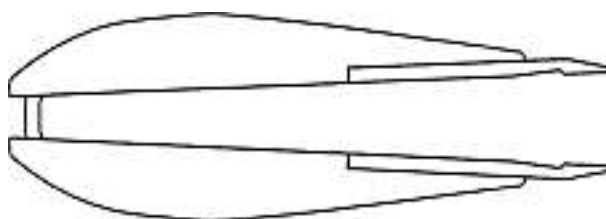
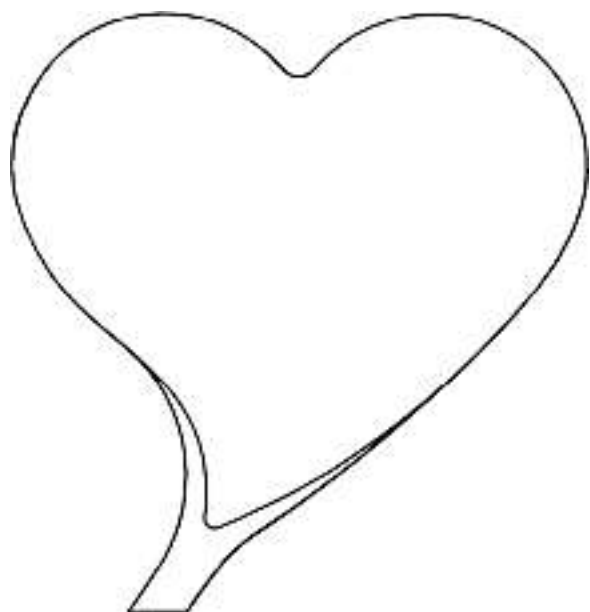
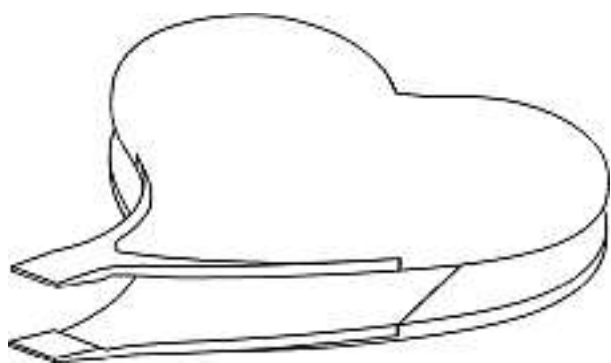

3

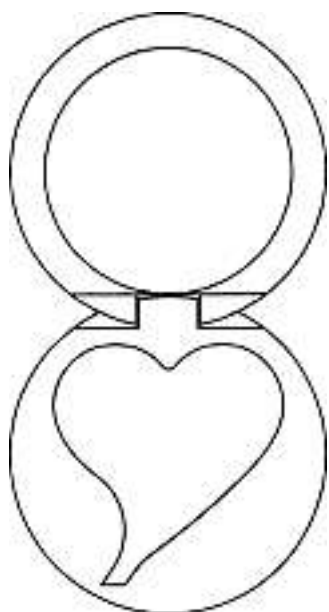

4

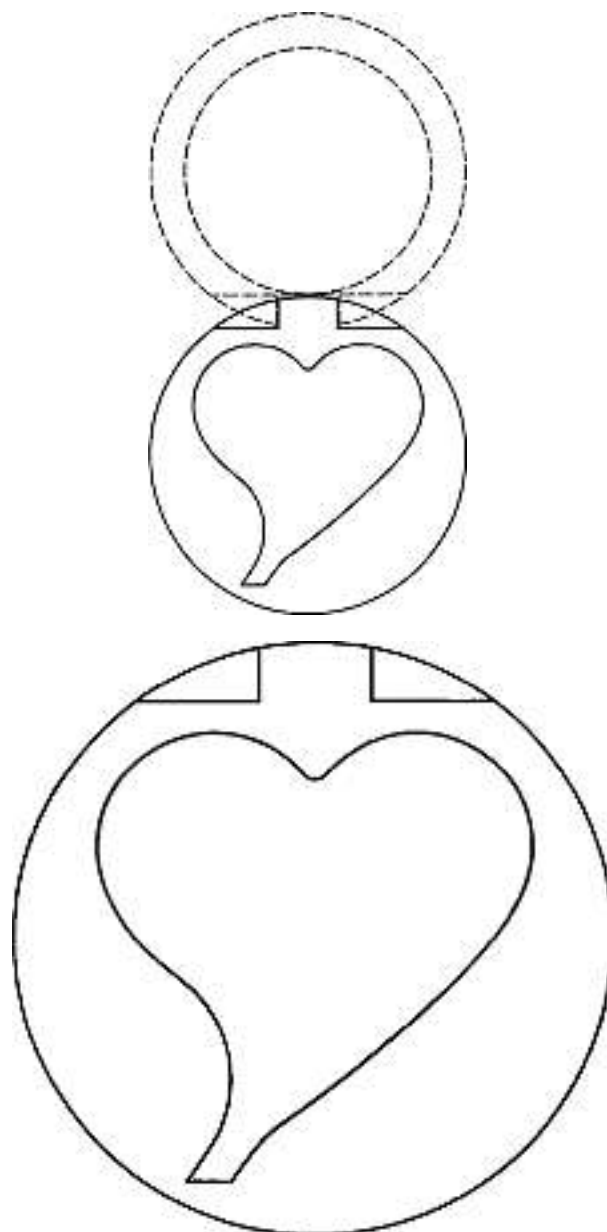

5

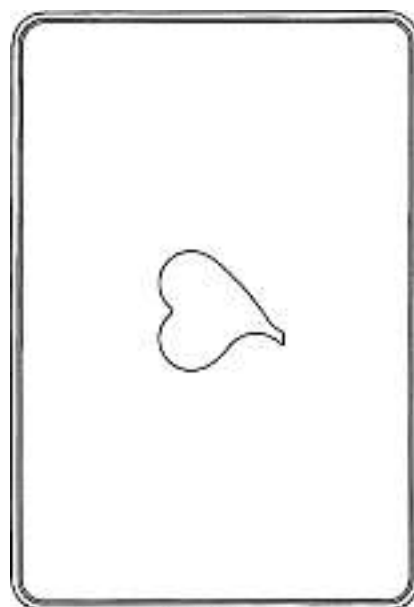

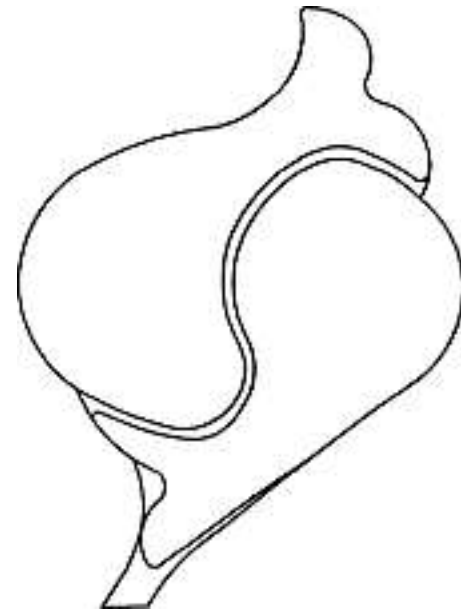
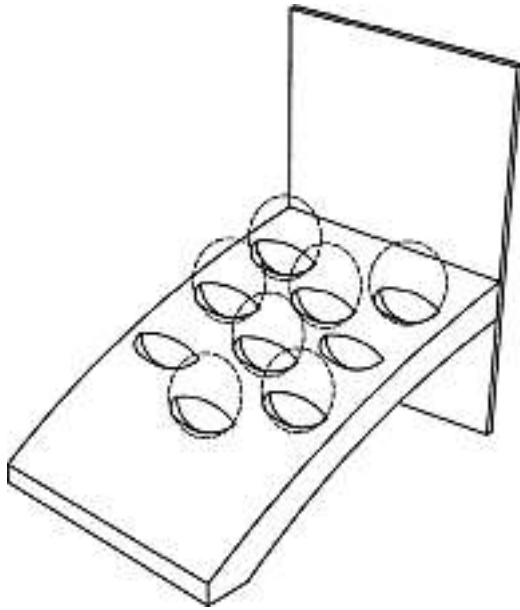
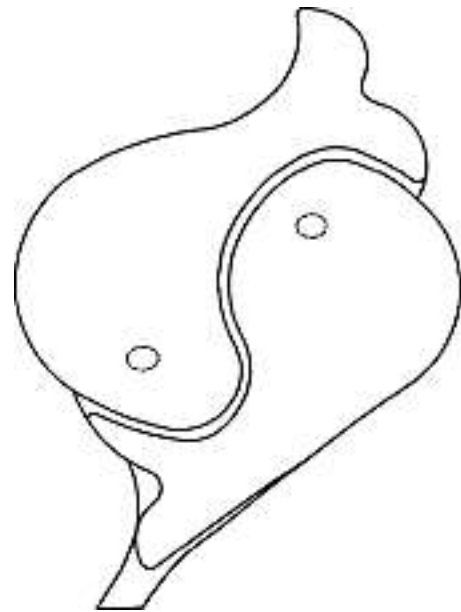
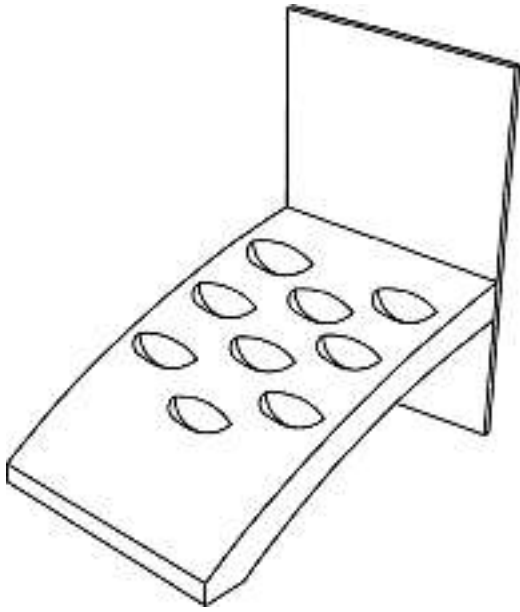

6

8

9

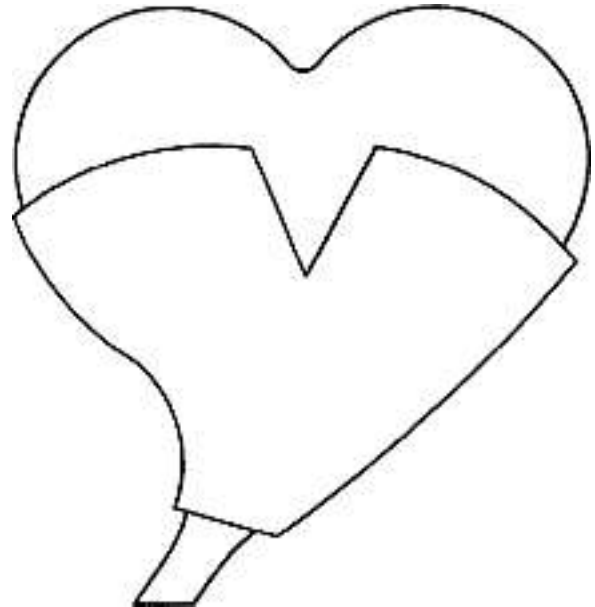
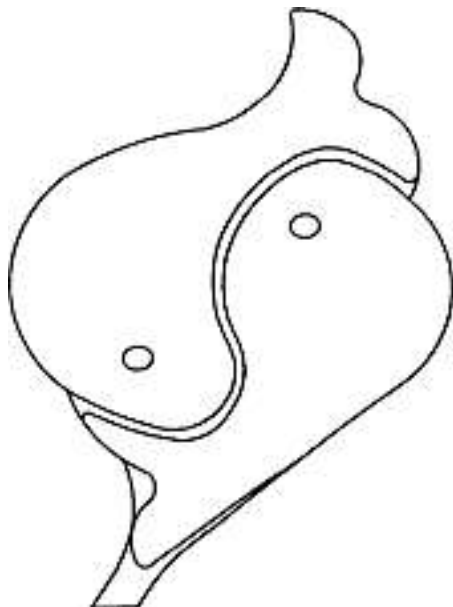

7

10

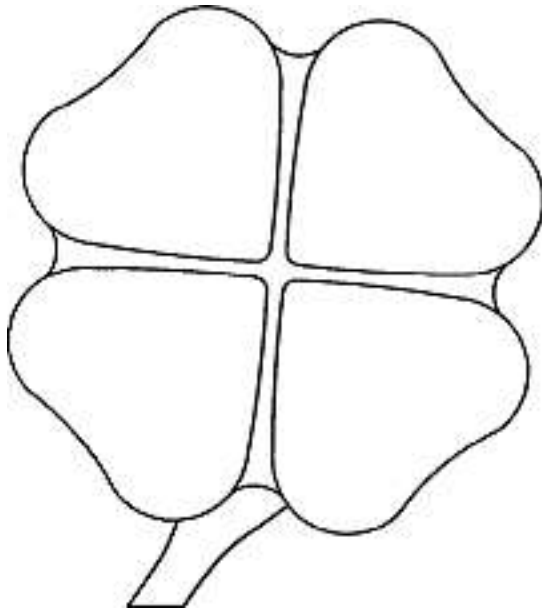

11

### Verlängerungen Prolongations Prolongazioni

117 362 Cl. 24-02 1 Design



1

117 490 Cl. 24-02 1 Design



1

117 525 Cl. 24-02 1 Design

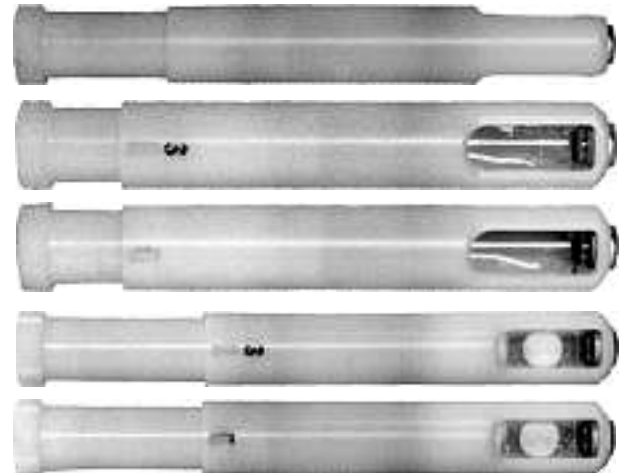

1

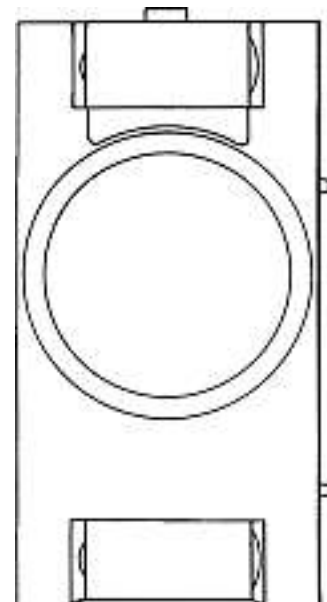
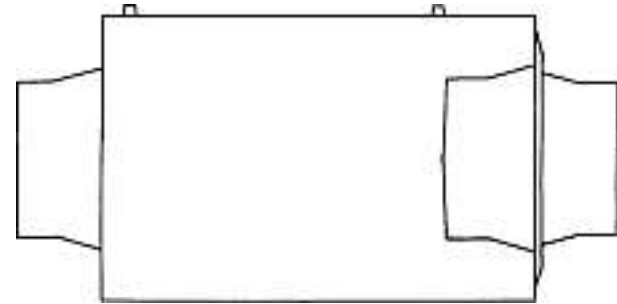
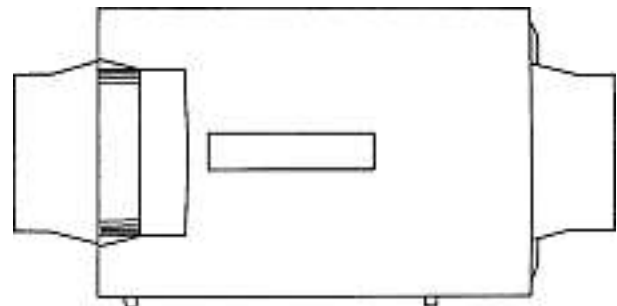
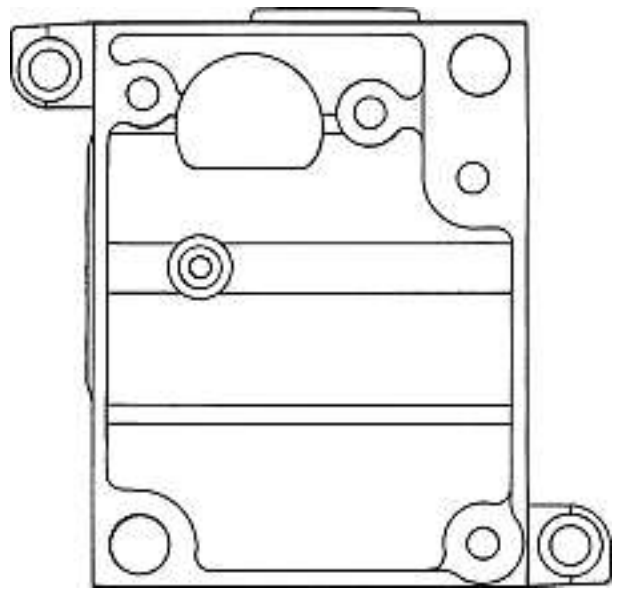
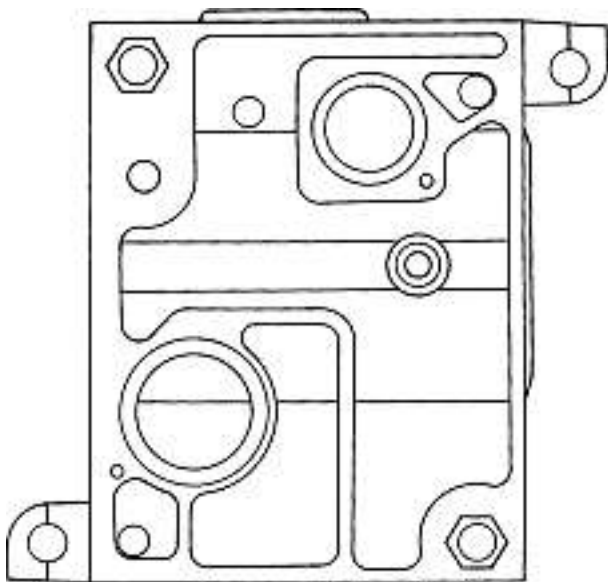
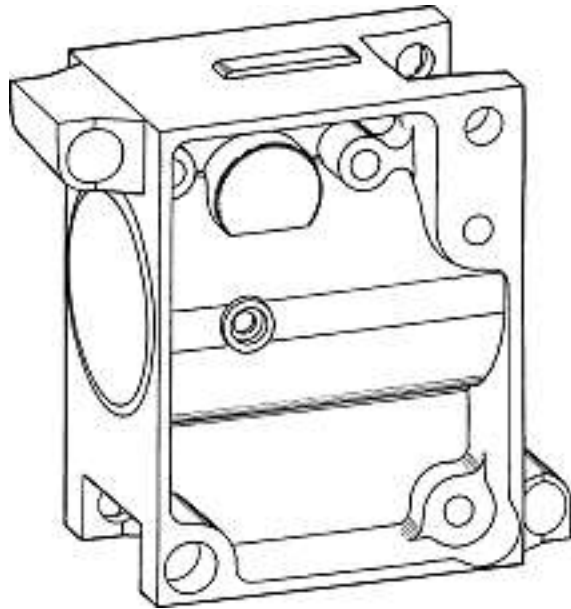
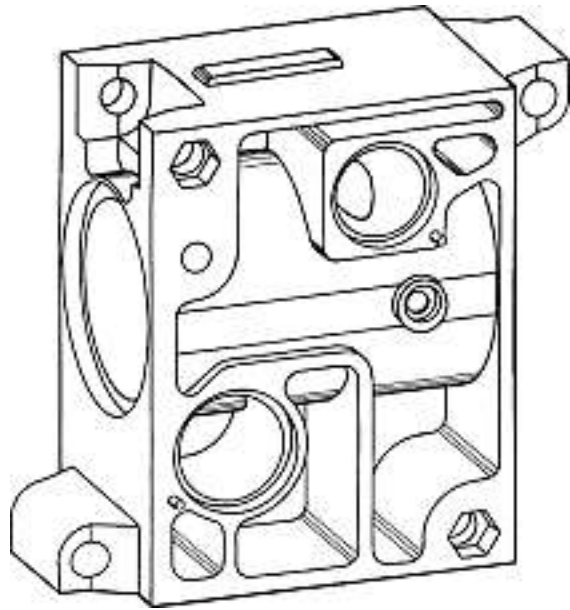

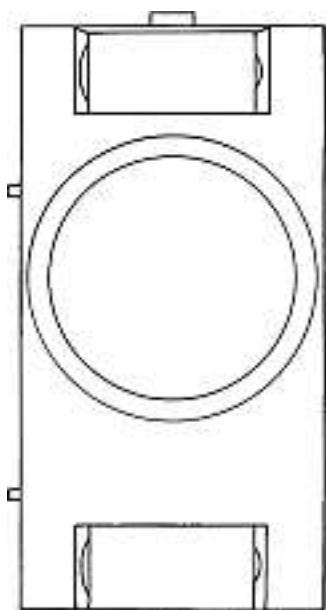

1

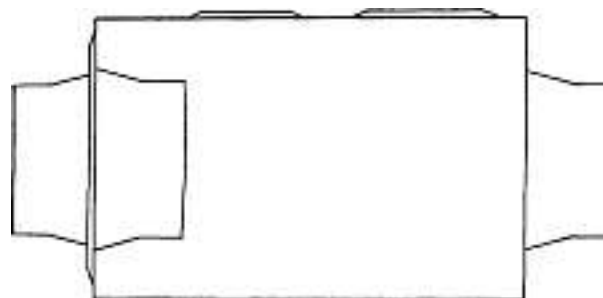
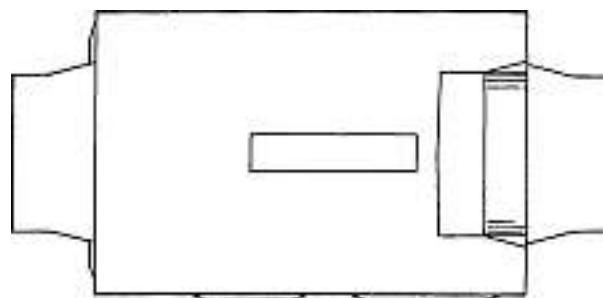
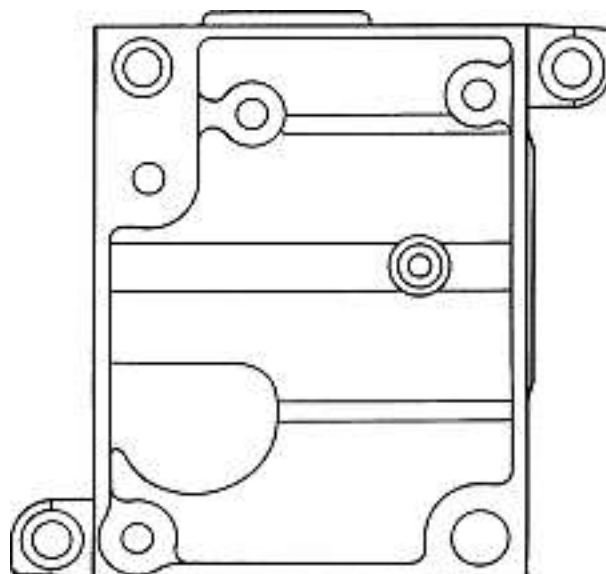
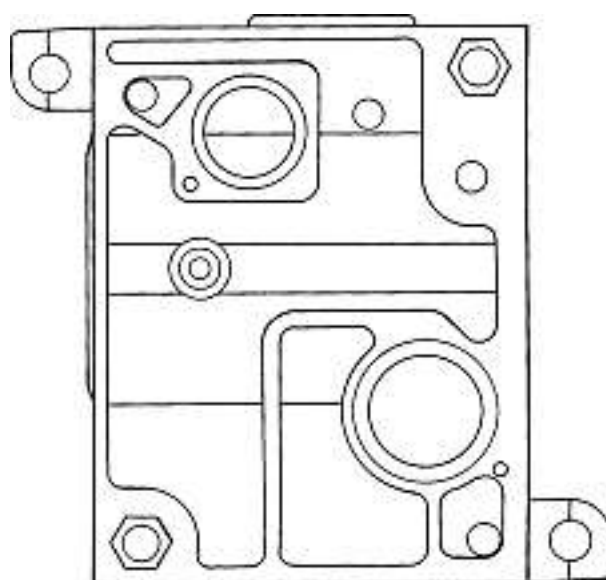
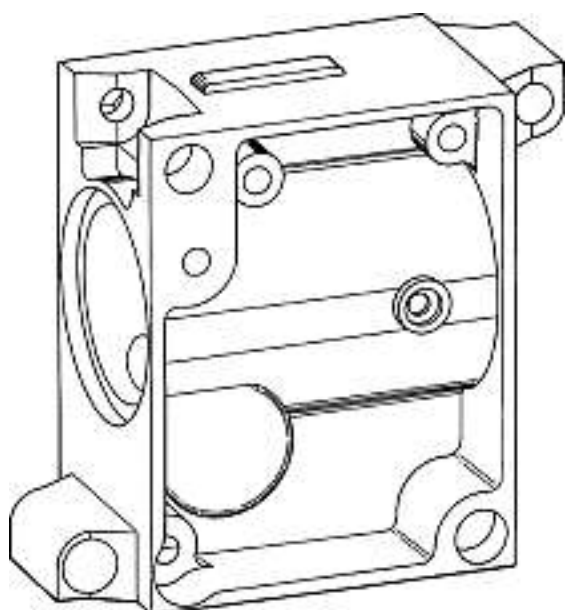
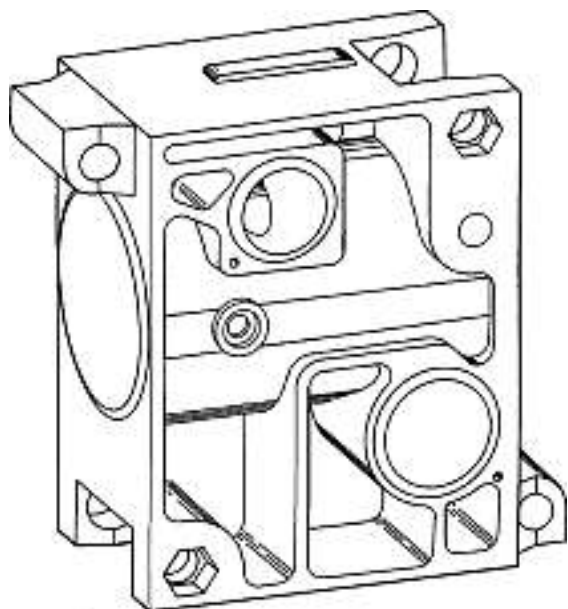

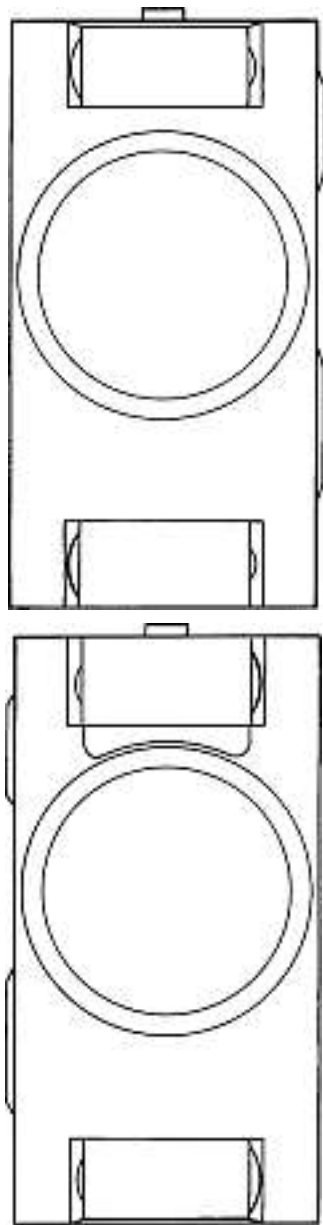

2

117 794 Cl. 23-01 1 Design

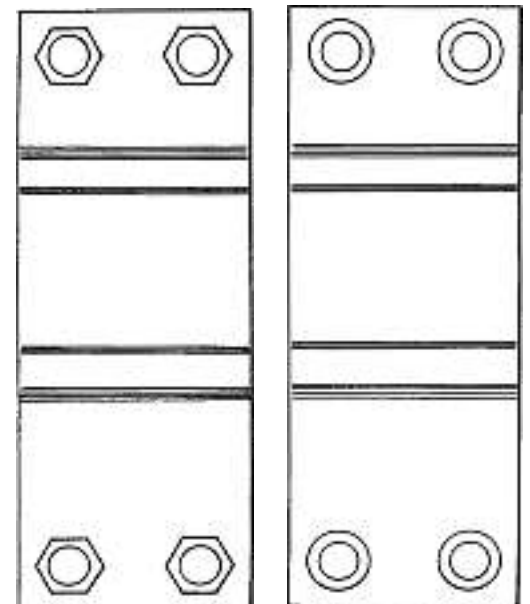
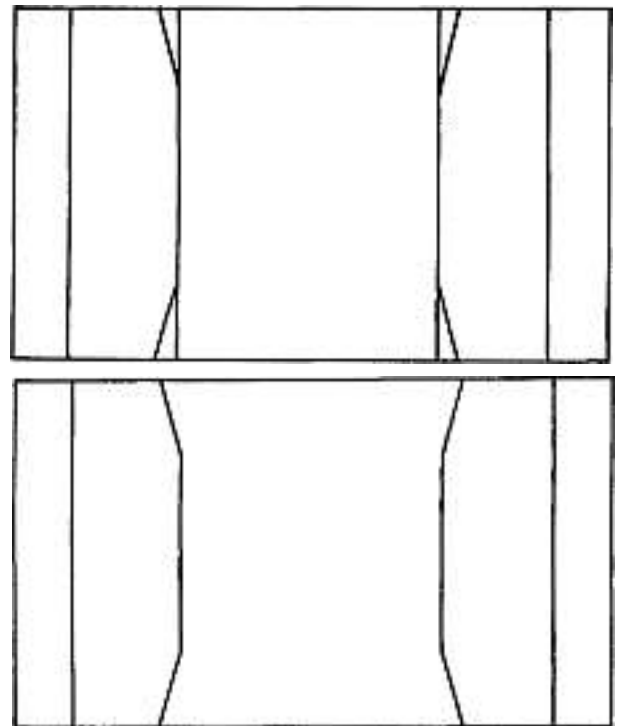
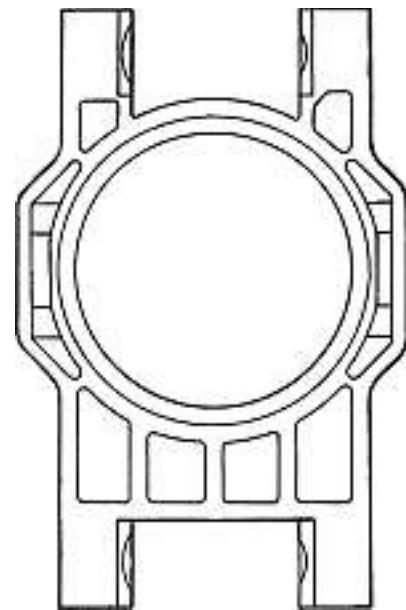
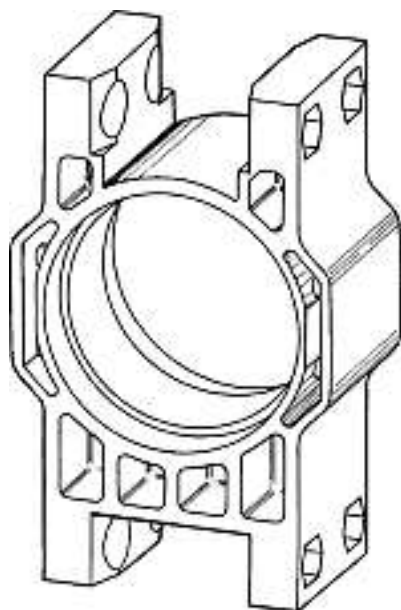

1



117 797 Cl. 24-02 1 design

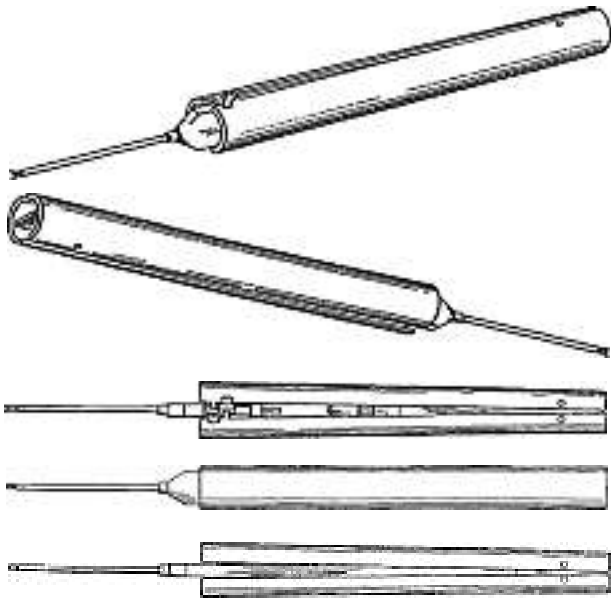

8076 CH MM

117 815 Cl. 21-01 16 Design

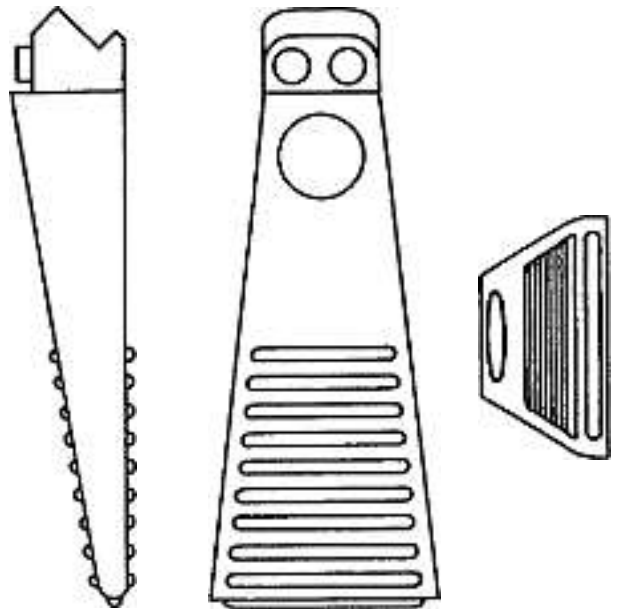
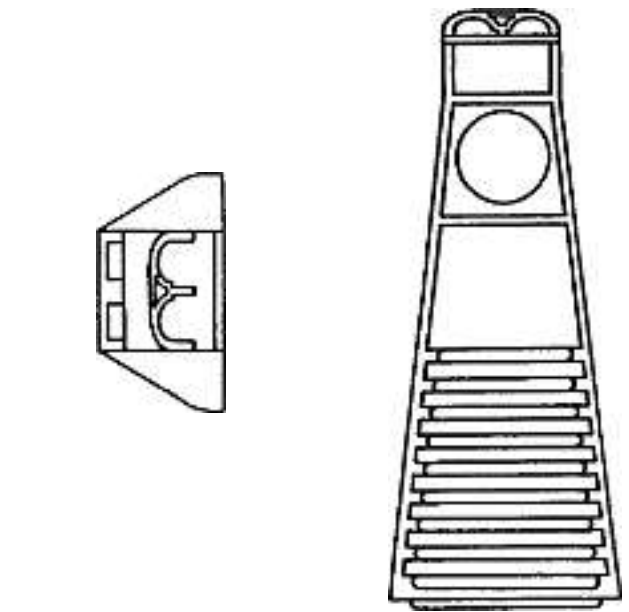
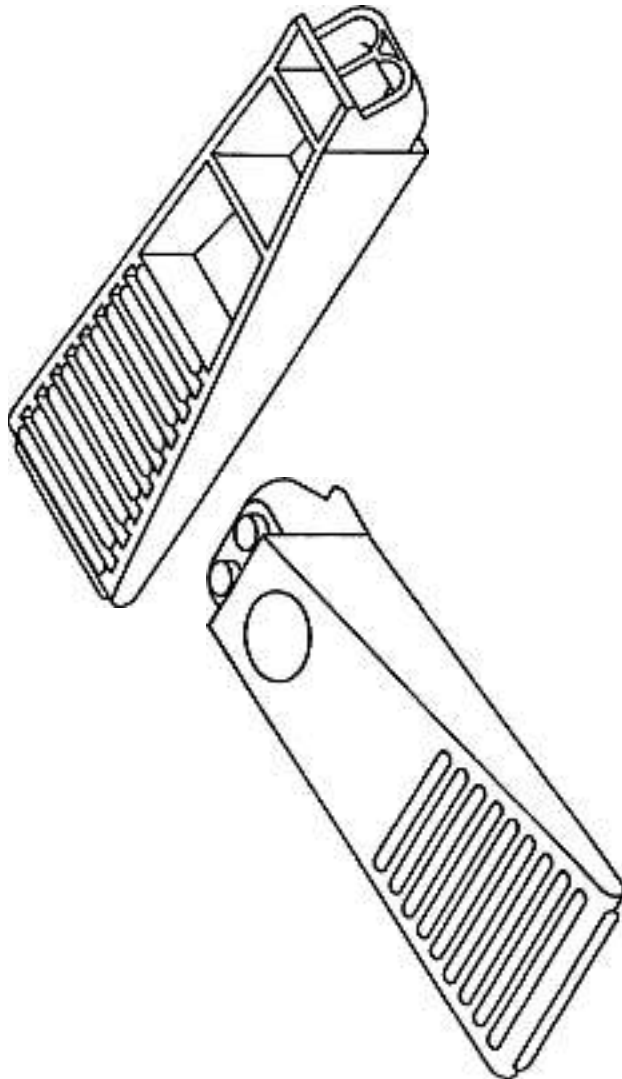

1

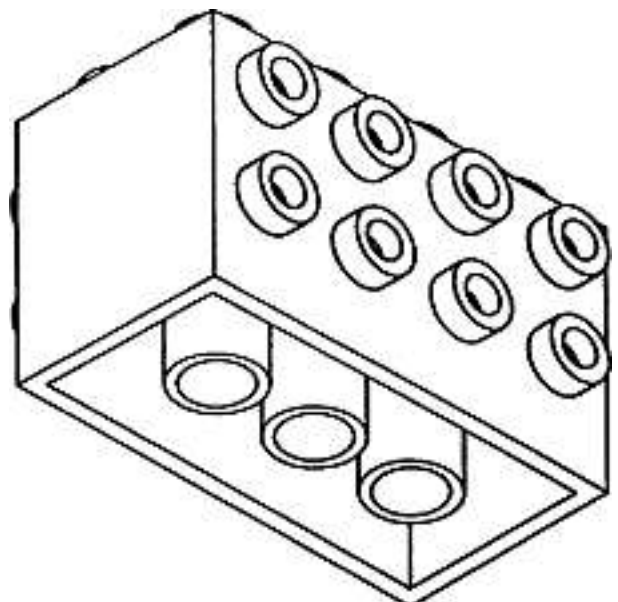

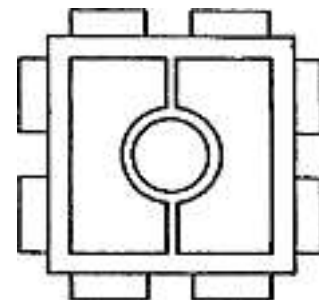
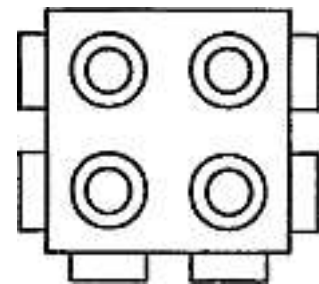
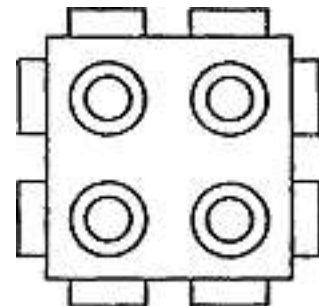
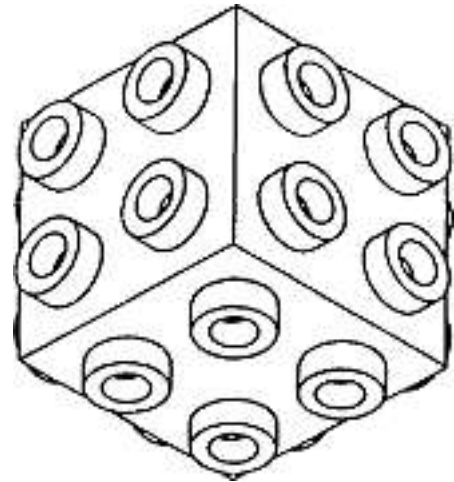
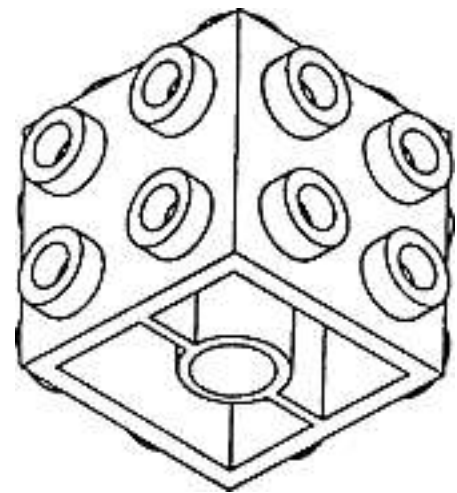
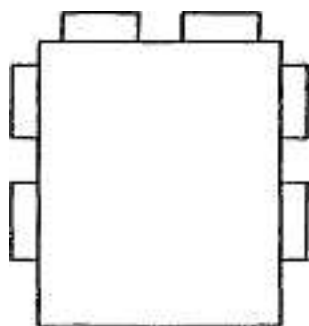
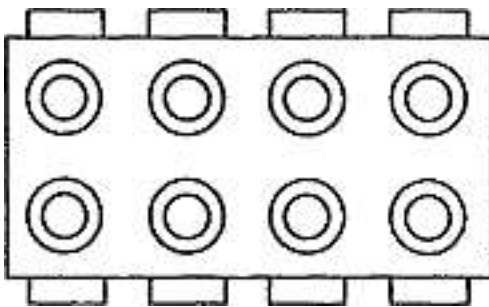
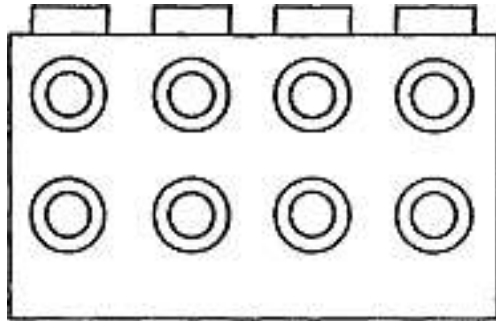
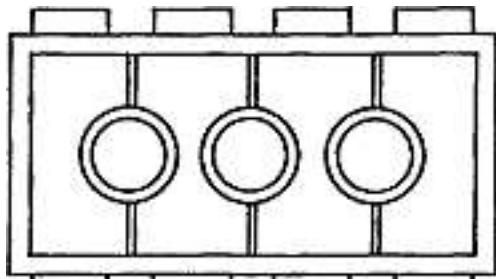
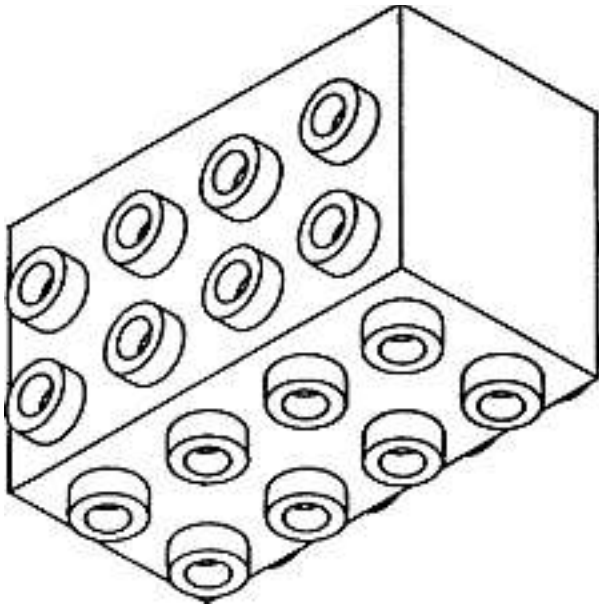

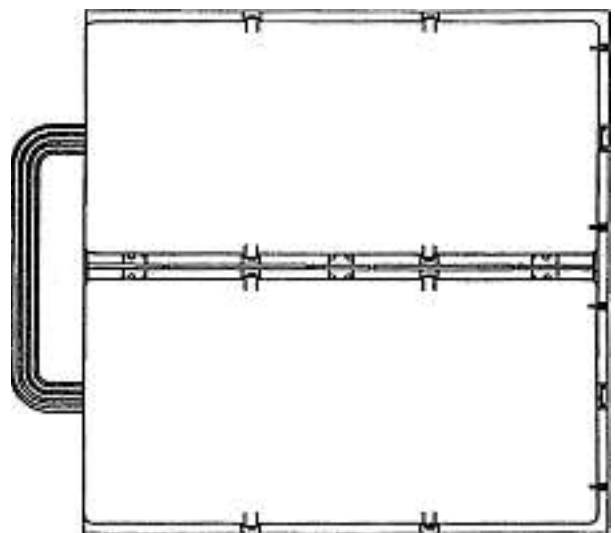
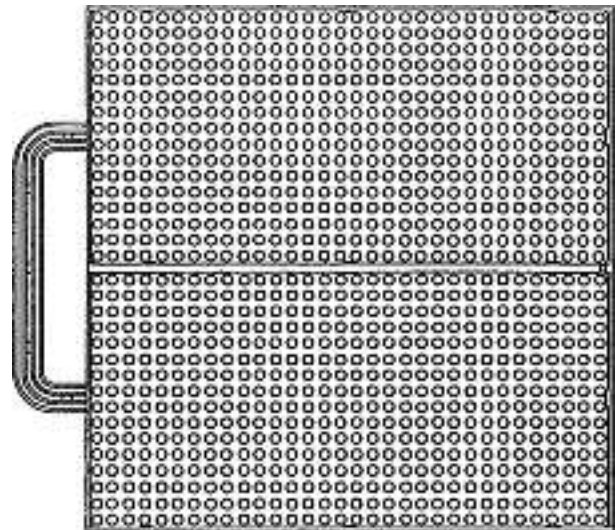
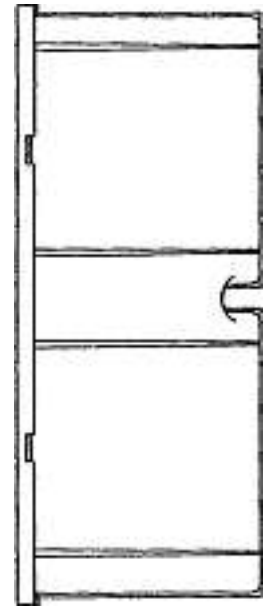
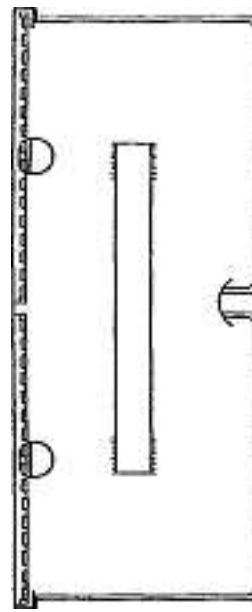
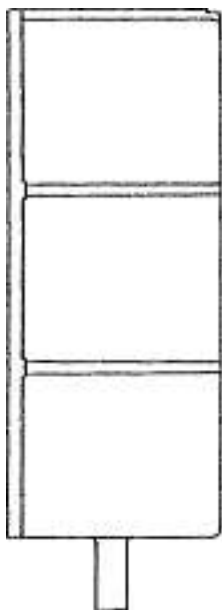
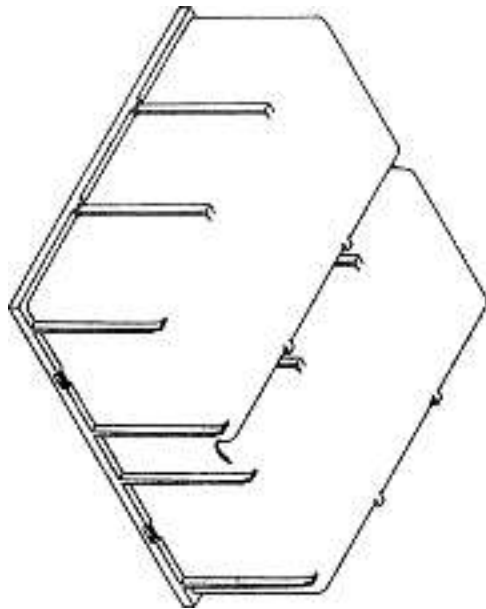
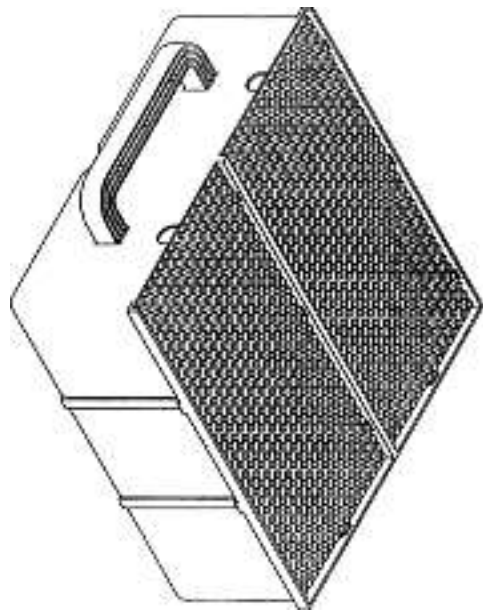

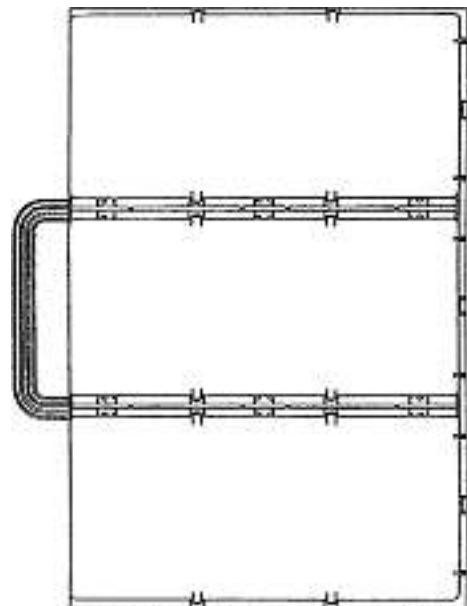
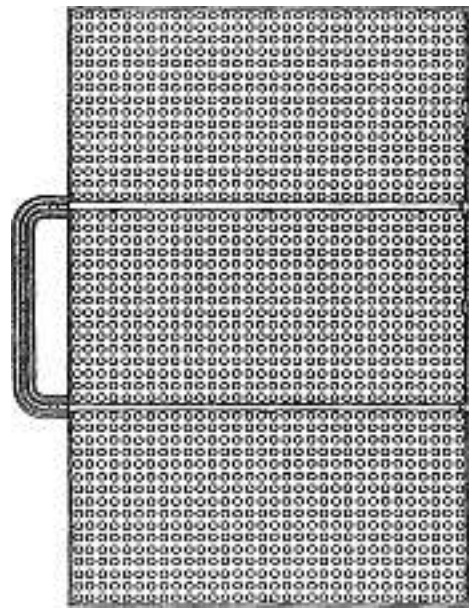
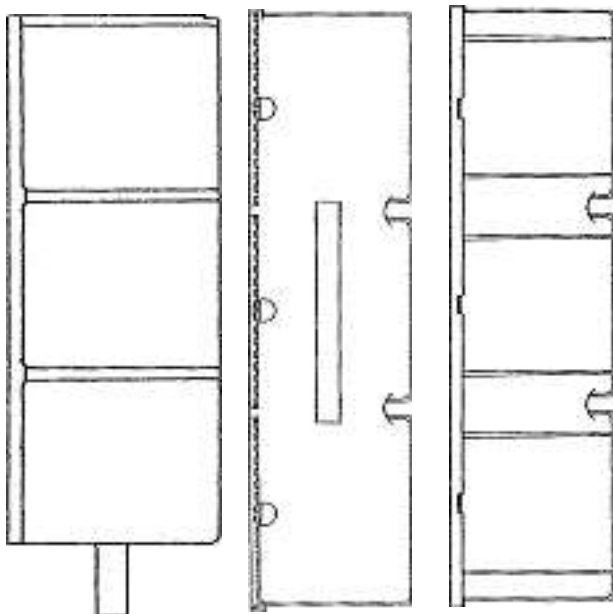
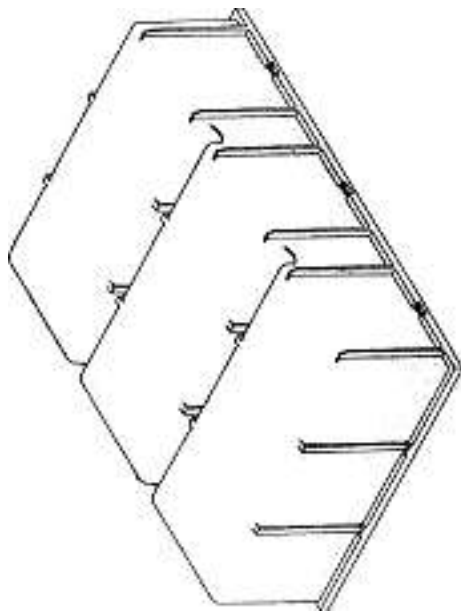
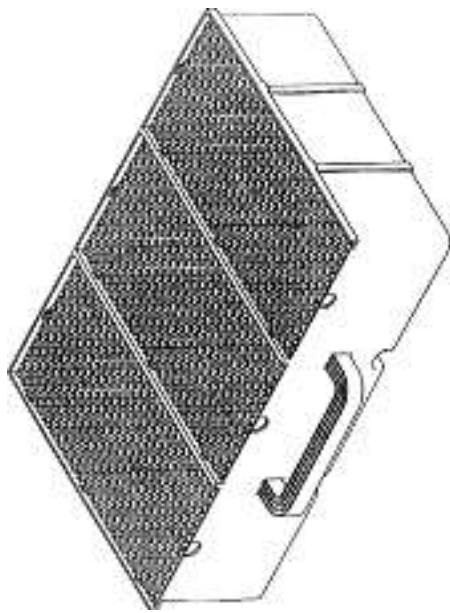

5

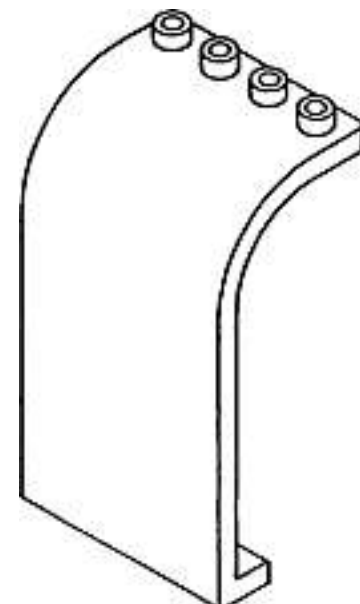

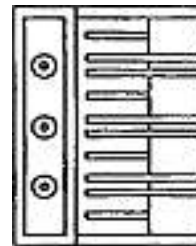
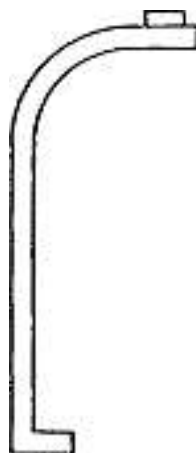
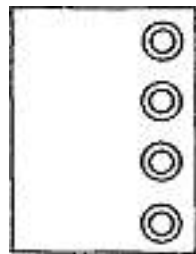
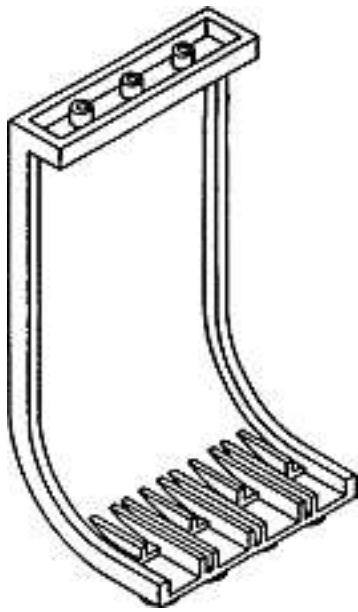

6

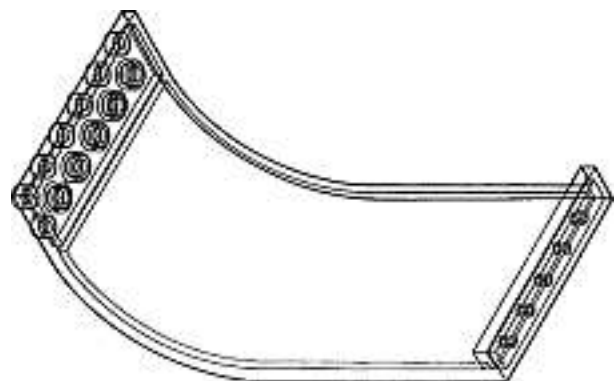
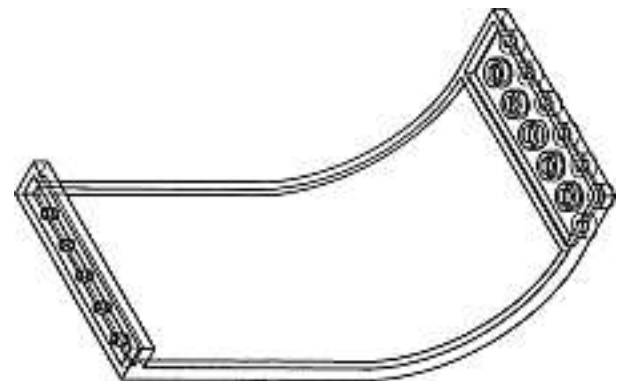

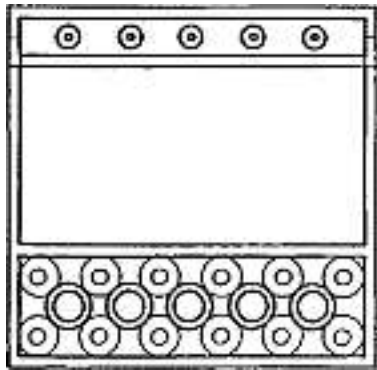
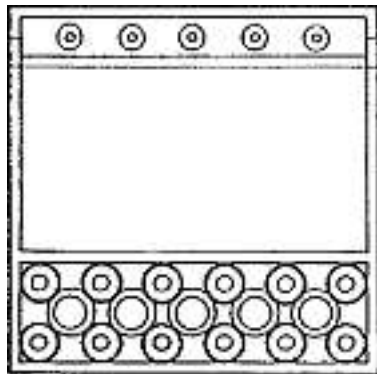
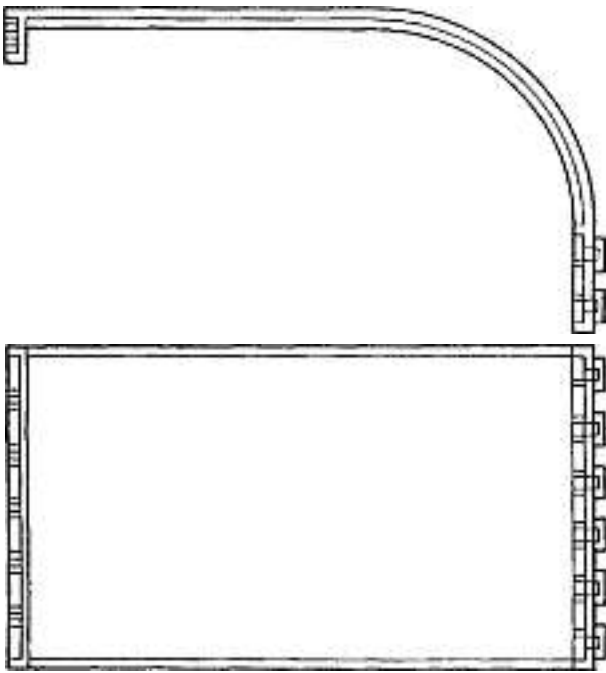

7

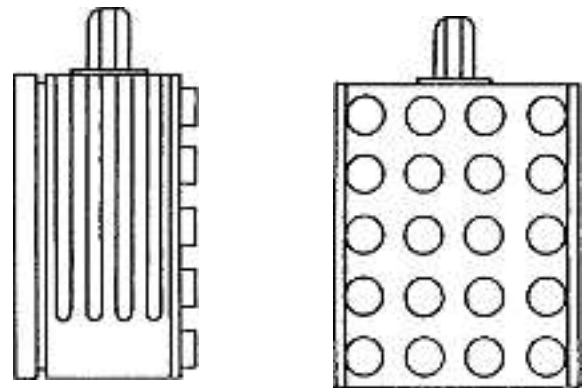
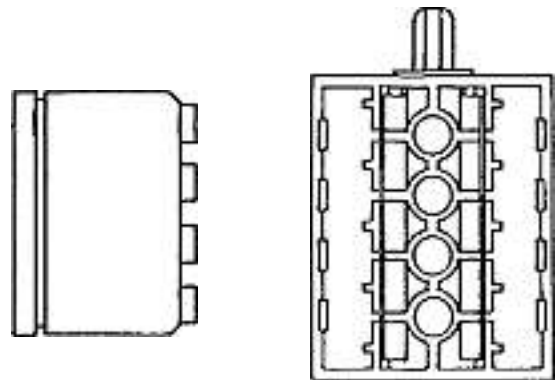
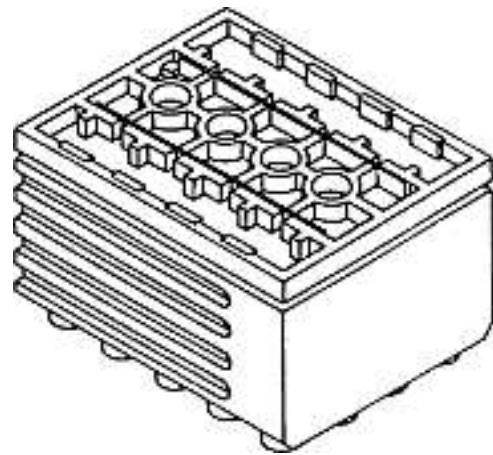
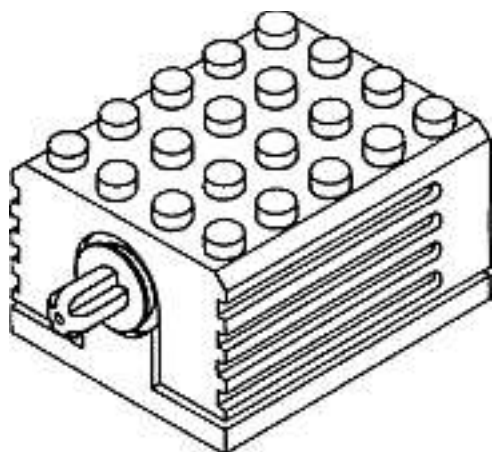

8

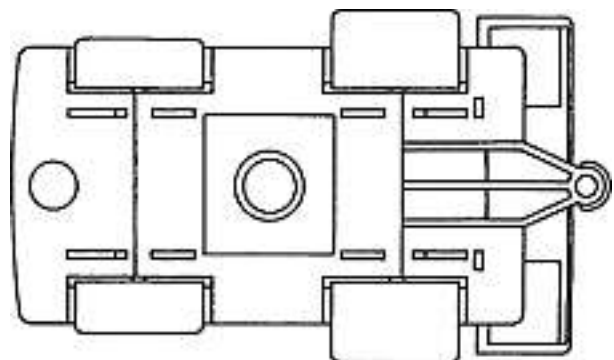

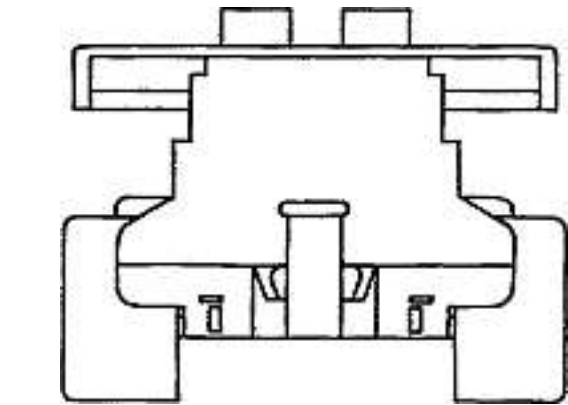
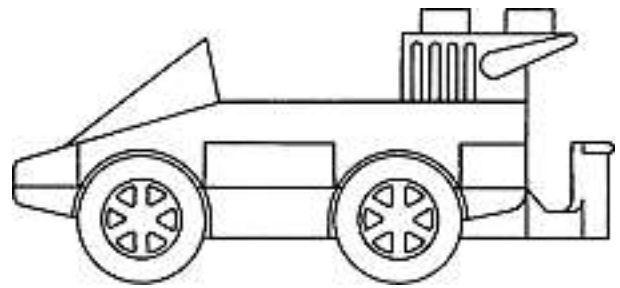
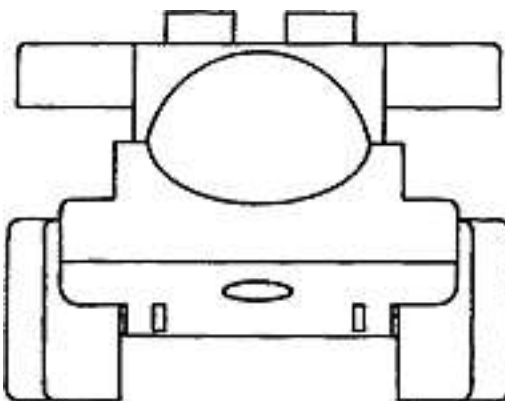
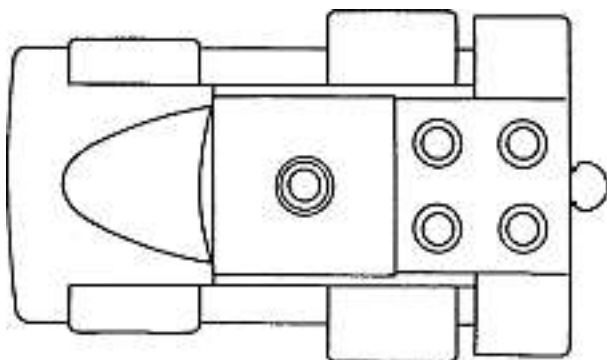
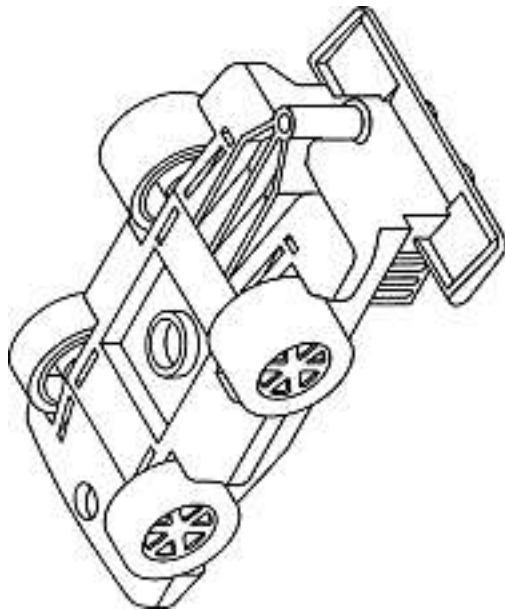
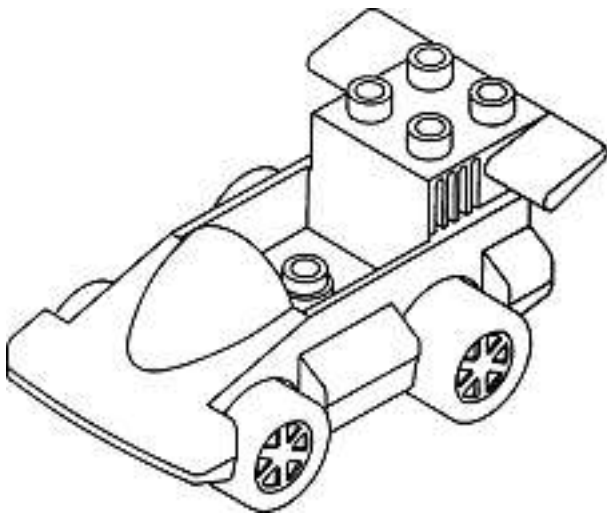

9

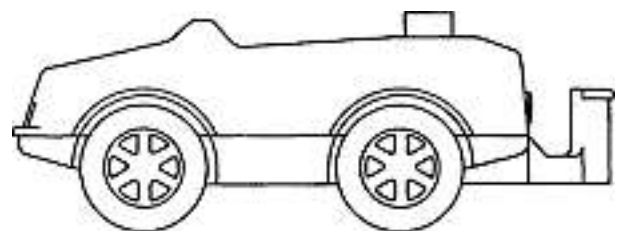
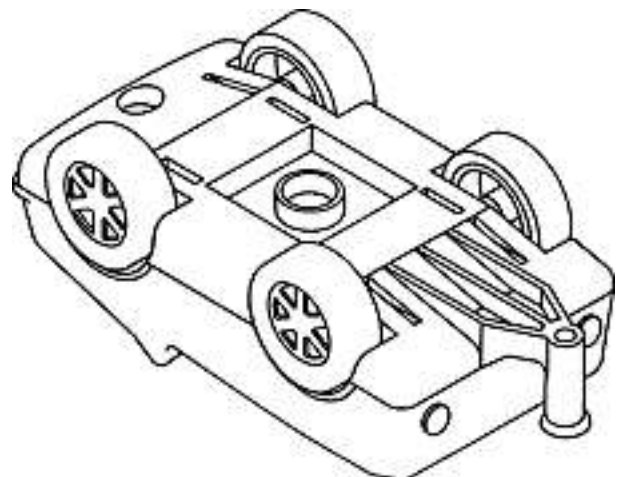
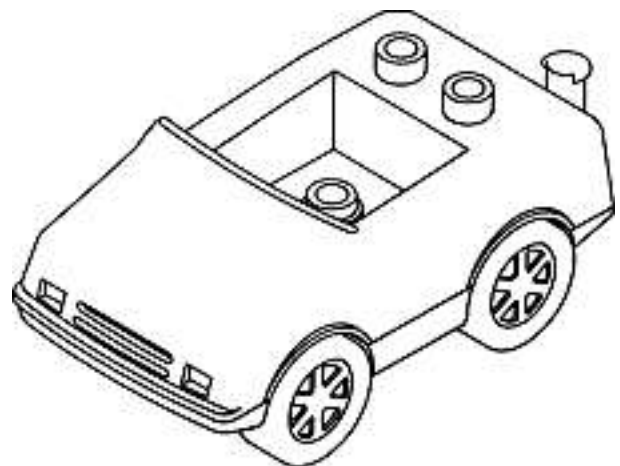

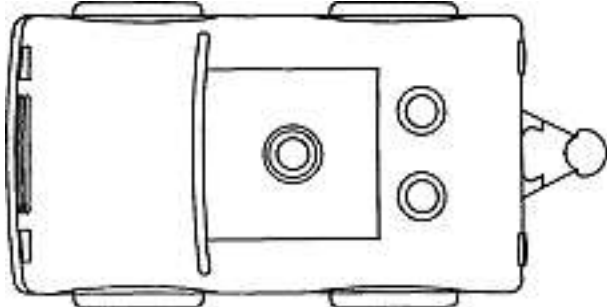
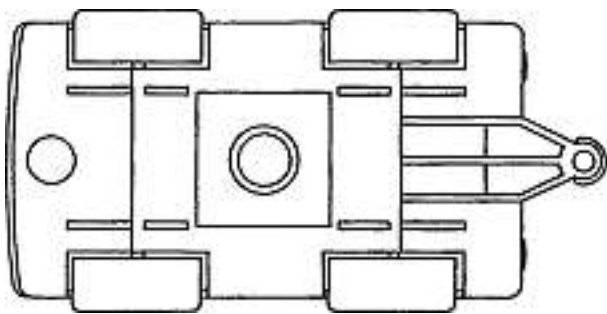
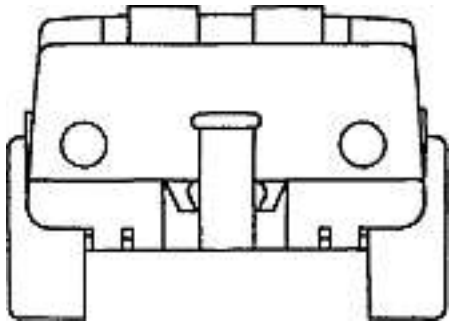
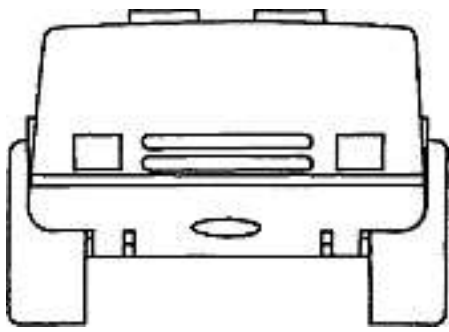

10

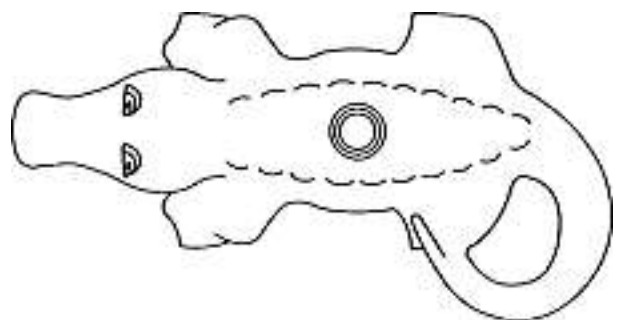
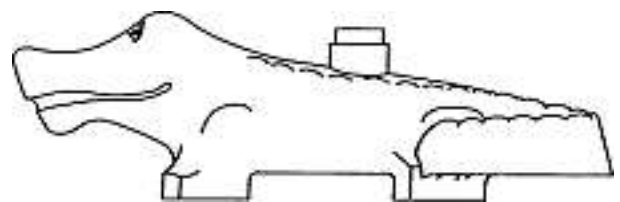
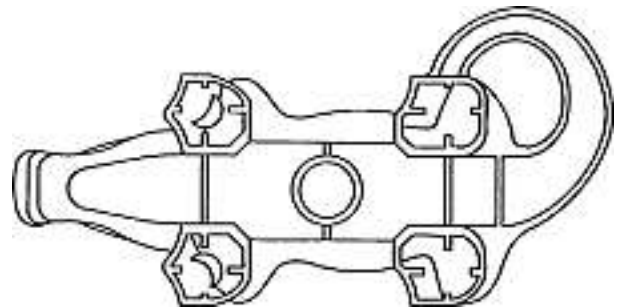
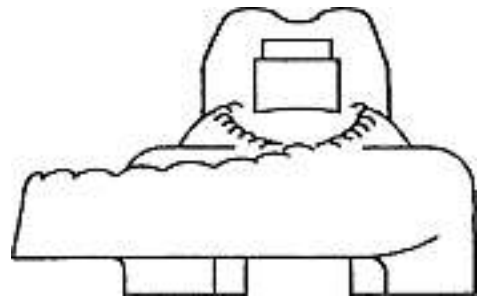
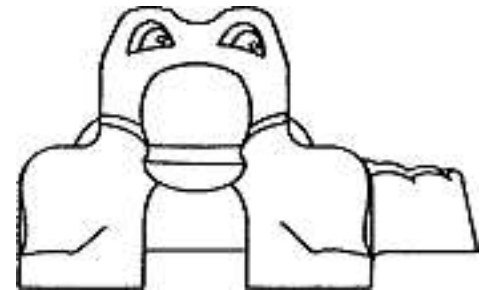
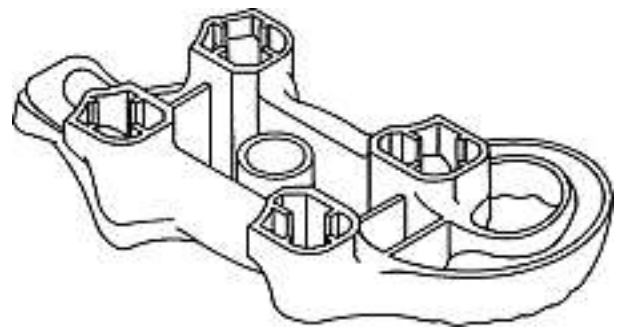
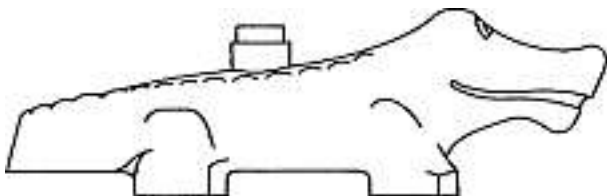
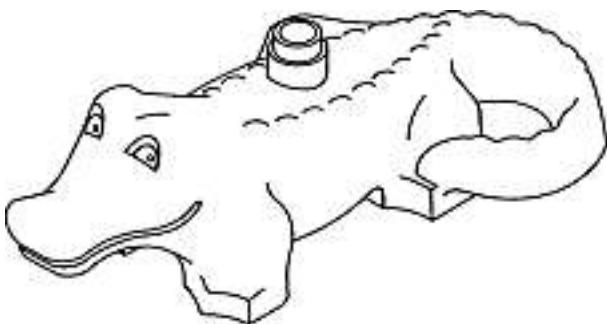

11



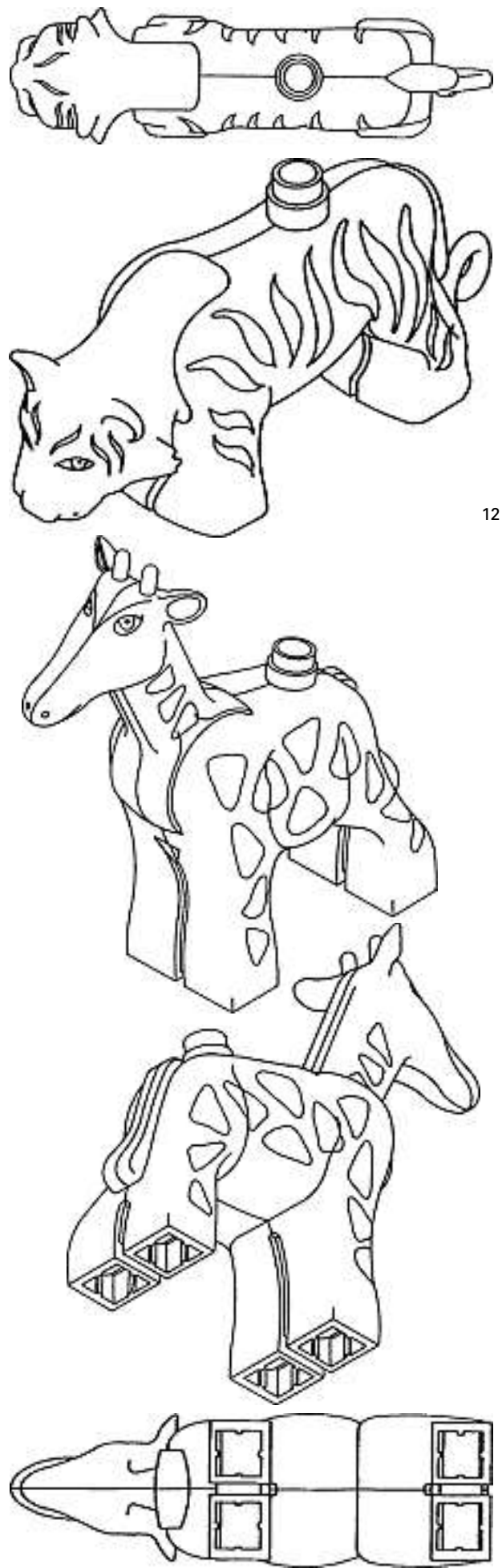
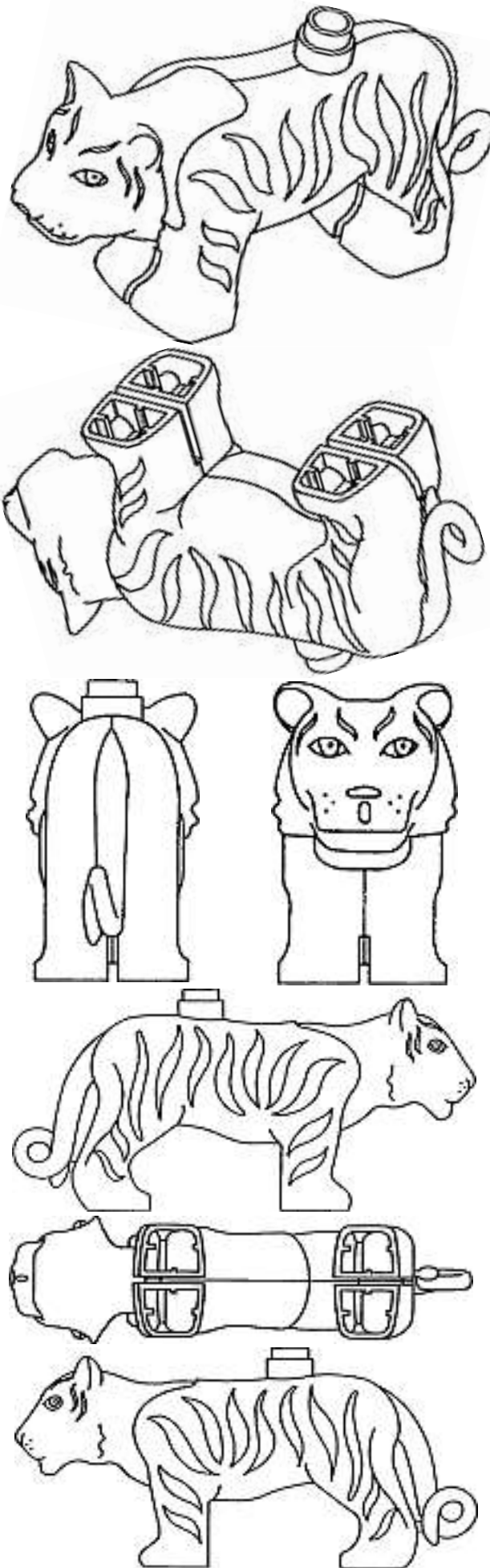

12

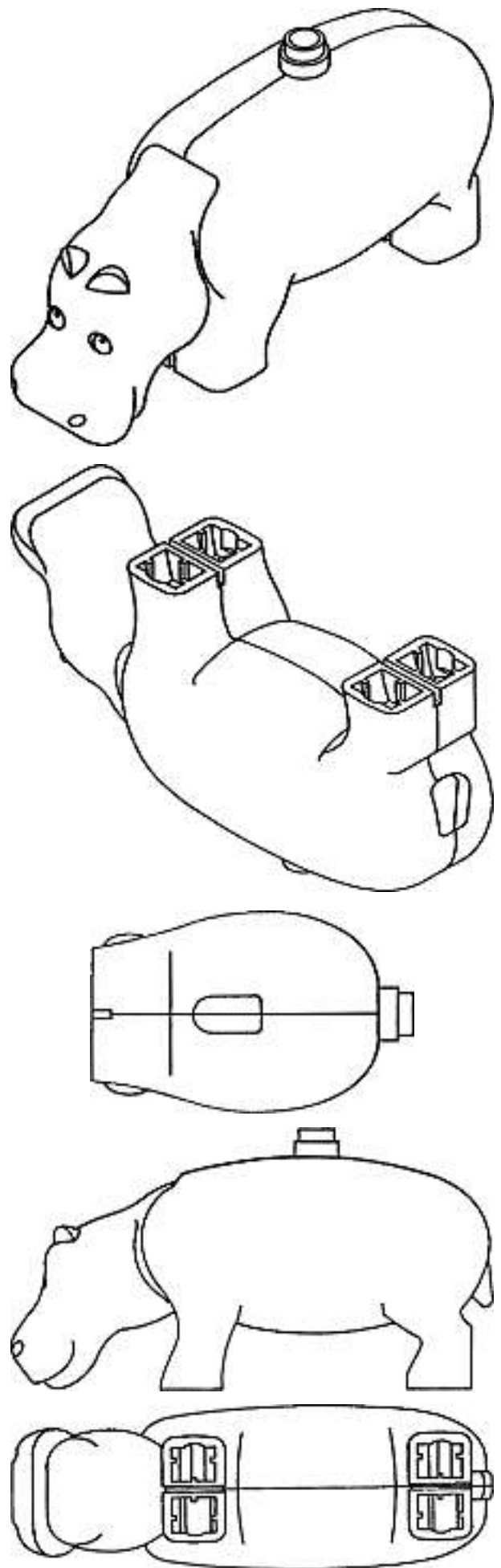
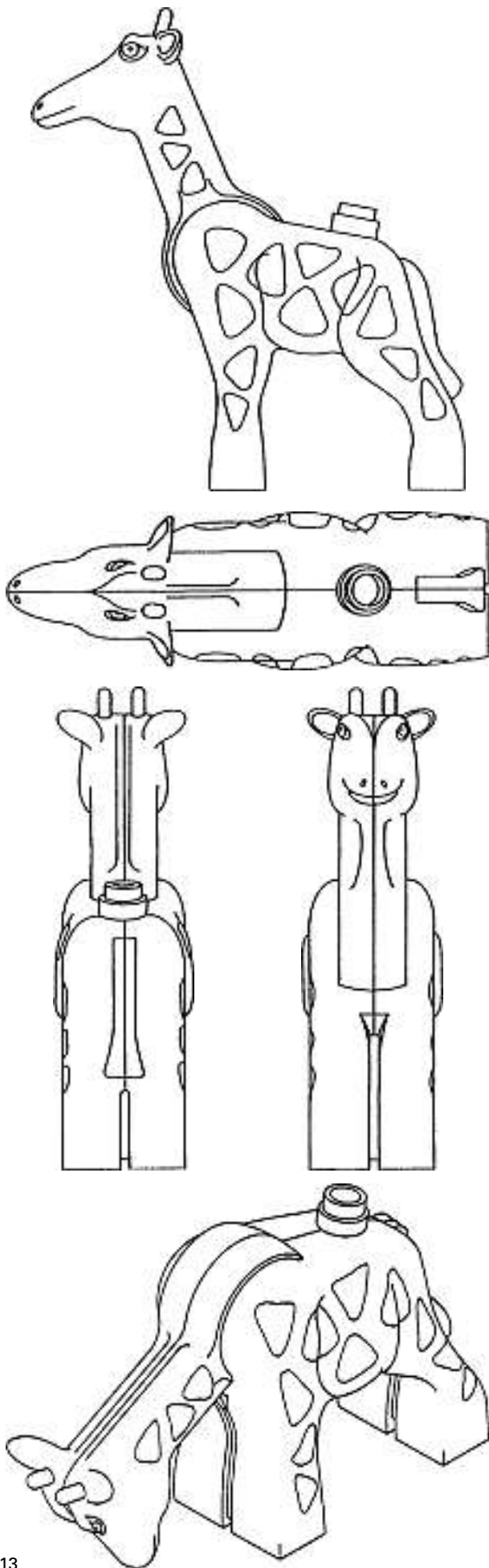

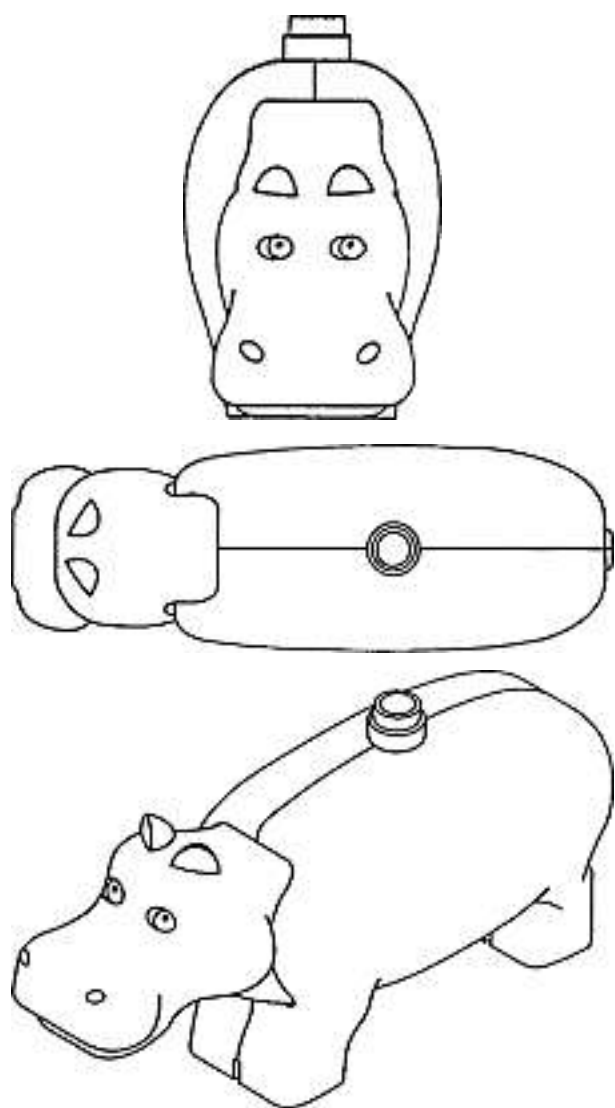

14

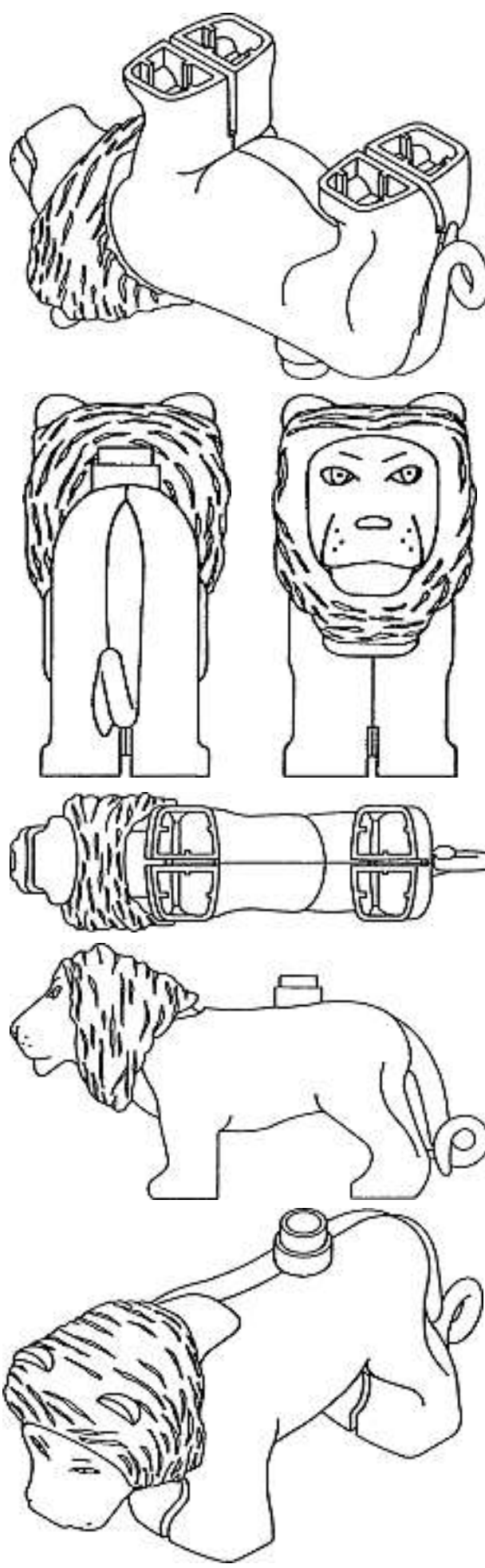
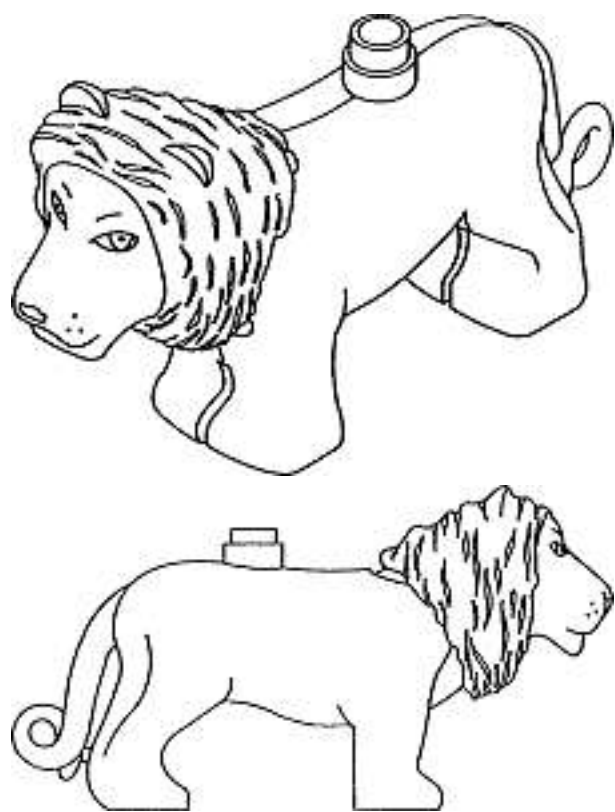

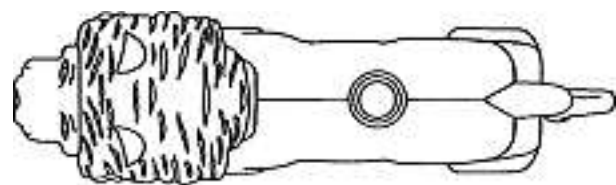

15

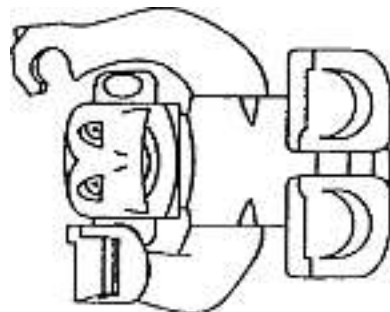
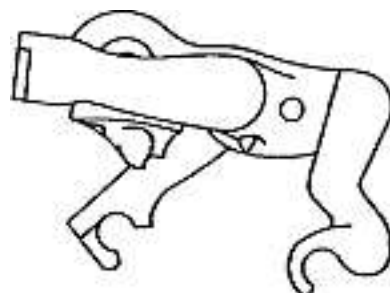
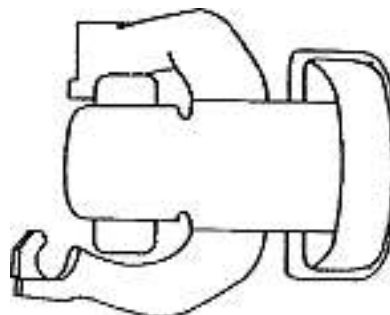
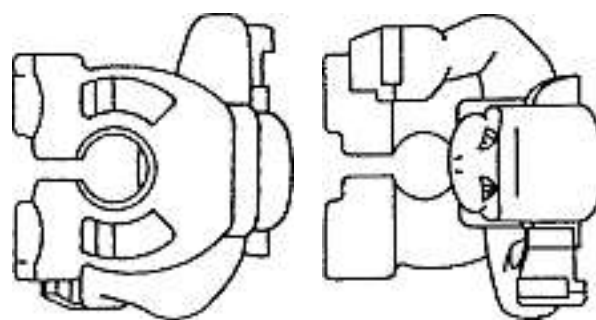
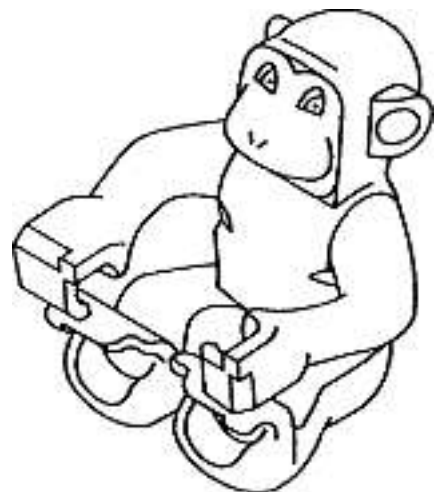
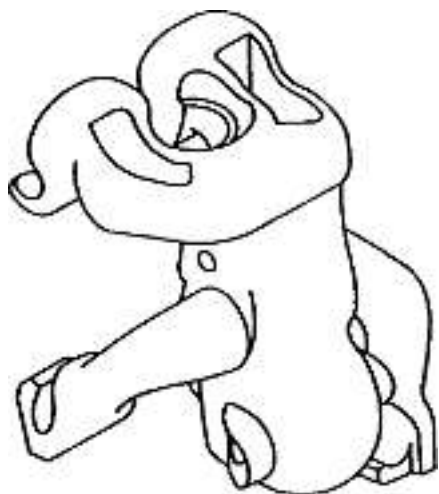
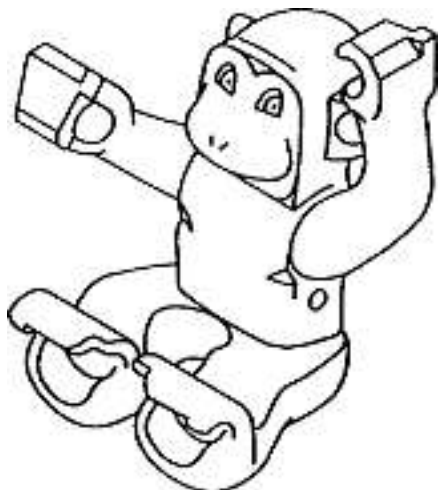

16

117 816 Cl. 22-06 1 Design

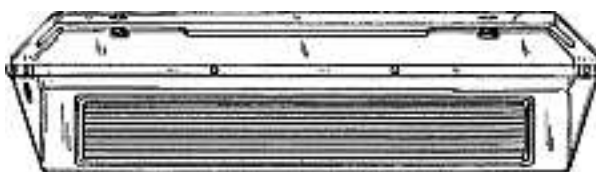

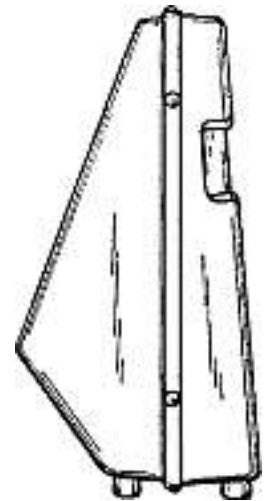
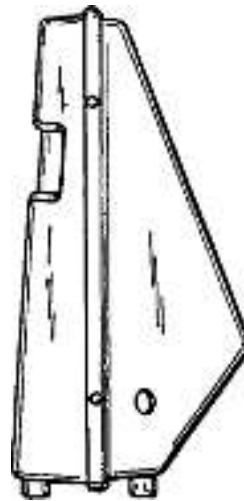
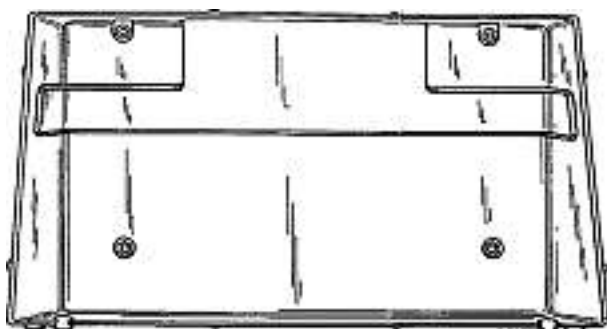
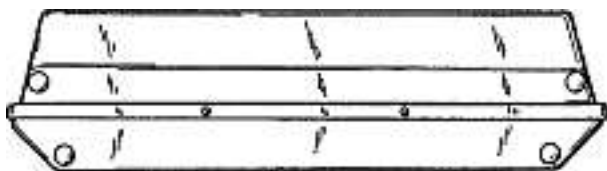
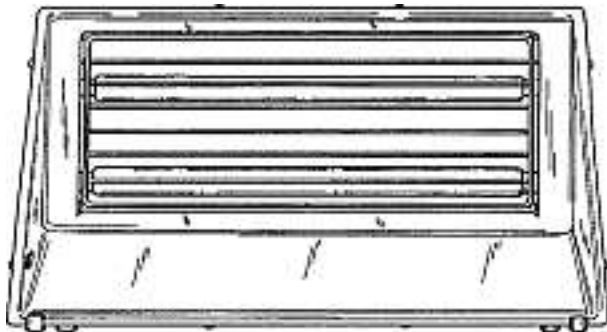
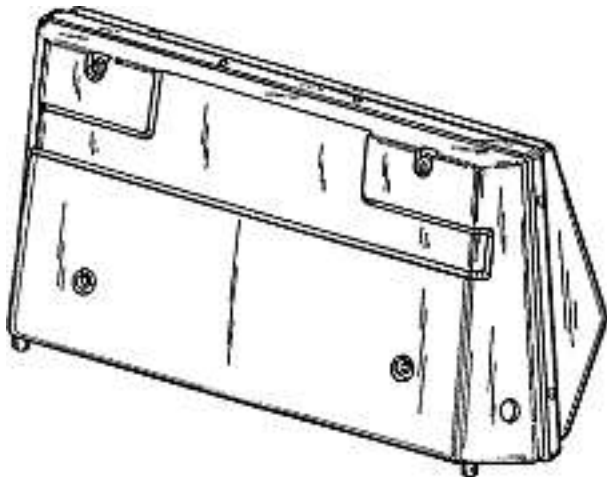
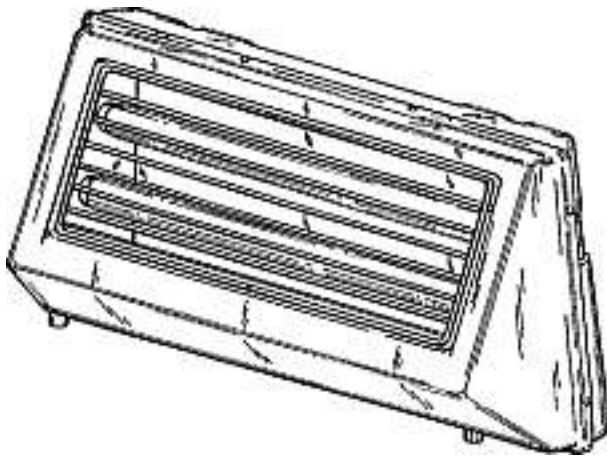

1

117 848 Cl. 28-02 1 Design



1

117 885 Cl. 23-01 1 Design

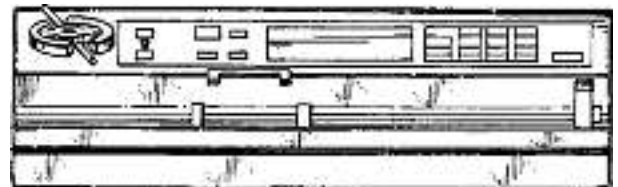
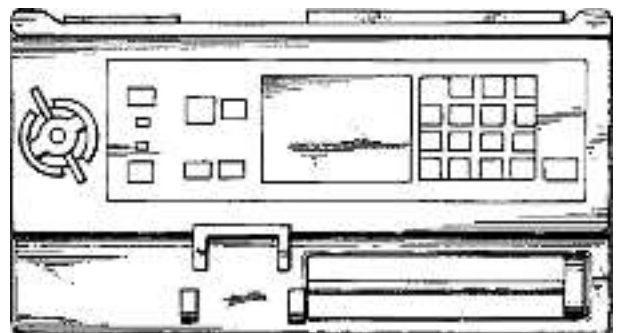
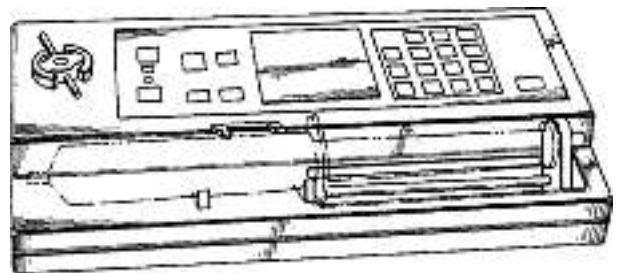

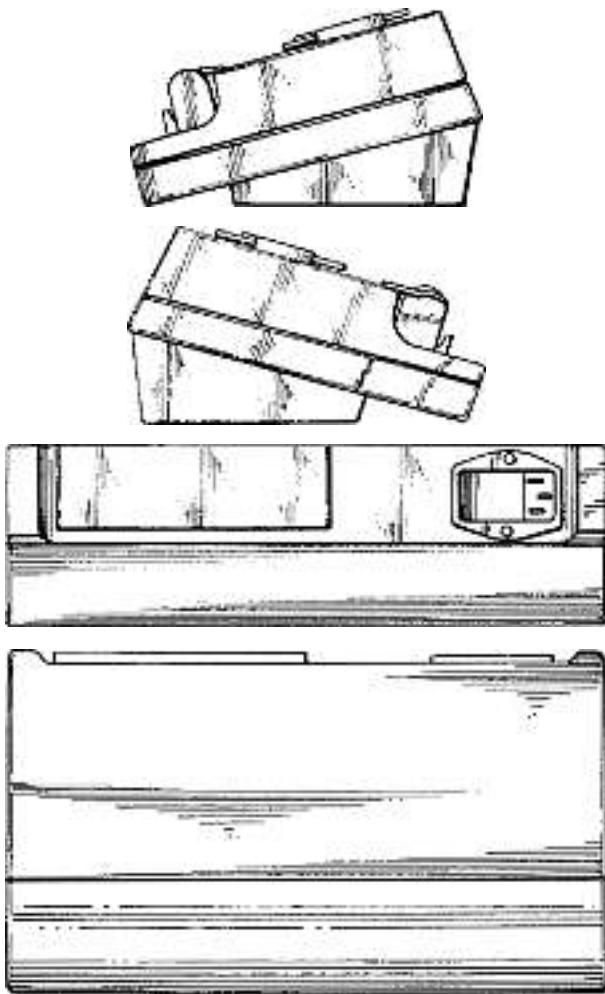

1

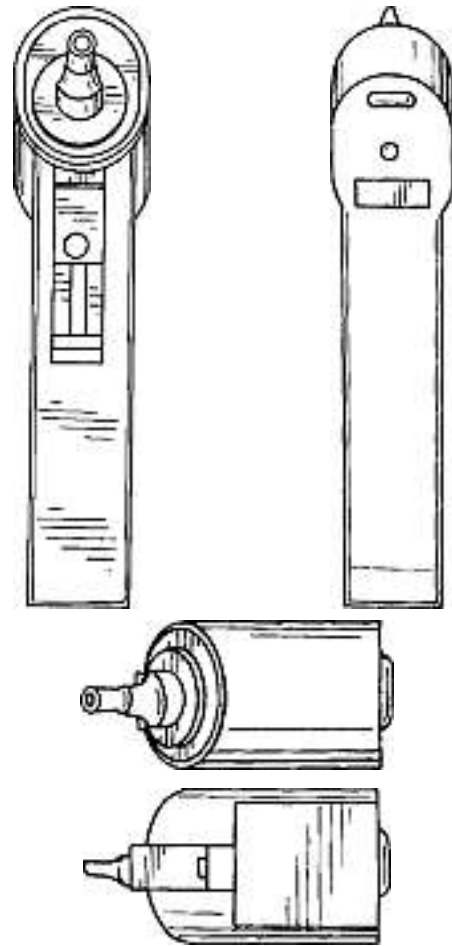

1

117 935 Cl. 10-04 1 Design

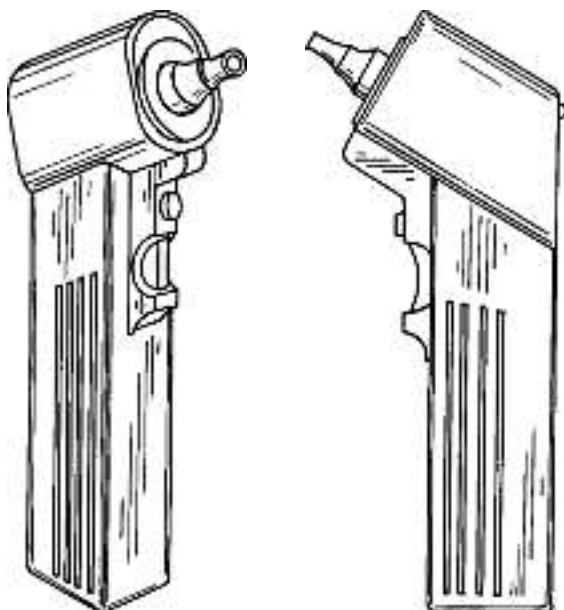

121 795	Cl.	06-01	1 Design
121 815	Cl.	19-02	2 design
121 817	Cl.	19-06	1 Design
121 855	Cl.	18-02	1 Design
121 909	Cl.	24-02	1 Design
121 912	Cl.	25-03	1 Design
122 094	Cl.	17-03	1 Design
126 264	Cl.	06-04	1 Design
126 453	Cl.	07-03	2 Design
126 488	Cl.	08-05	3 Design
126 538	Cl.	08-03	6 Design
126 546	Cl.	23-01	1 Design
126 554	Cl.	01-01	1 design
126 572	Cl.	09-03	1 design
126 573	Cl.	10-02	1 design
126 597	Cl.	06-01	1 Design
126 690	Cl.	12-08	1 design
126 691	Cl.	12-08	2 Design
126 714	Cl.	07-02	1 Design
126 715	Cl.	07-02	1 Design
126 719	Cl.	09-01	1 Design
126 724	Cl.	10-02	5 Design
126 736	Cl.	17-04	1 Design
126 749	Cl.	06-01	1 Design
126 752	Cl.	08-04	21 Design
126 887	Cl.	10-07	1 Design

**Mutationen**  
**Modifications**  
**Modificazioni**

**125 358**

Übertragung

Hinterleger: Zeiss-Neutra SA, 6703 Osogna

Vertreter: Dr. Patrick Troller, 6002 Luzern

**126 554****126 572**

Nouveau mandataire

Mandataire: Wild Schnyder AG, 8032 Zürich

**126 719**

Neuer Vertreter

Vertreter: Bovard AG, 3000 Bern 25

**127 240**

Übertragung

Hinterleger: Rovcal Inc., 601 Rayovac Drive, Madison,

Wisconsin 53711, US

Vertreter: Riederer Hasler &amp; Partner, Patentanwälte AG,

7310 Bad Ragaz

**Löschungen**  
**Radiations**  
**Radiazioni**

117 349	Cl.	10-07	1 Design
117 377	Cl.	08-08	1 Design
117 394	Cl.	10-04	2 Design
117 440	Cl.	12-12	1 Design
121 288	Cl.	09-01	1 Design
121 306	Cl.	19-01	1 Design
121 311	Cl.	22-01	1 design
121 314	Cl.	23-01	1 design
121 328	Cl.	07-04	1 Design
121 390	Cl.	13-03	8 Design
121 414	Cl.	09-01	1 Design
125 908	Cl.	02-04	6 Design
125 926	Cl.	07-06	3 design
125 927	Cl.	08-03	3 Design
125 928	Cl.	08-08	1 design
125 946	Cl.	10-02	1 design
125 974	Cl.	25-01	1 design
125 976	Cl.	25-03	1 Design
125 980	Cl.	03-01	1 design
125 981	Cl.	03-01	1 Design
125 982	Cl.	06-01	4 Design
125 984	Cl.	06-01	1 Design
125 985	Cl.	06-03	2 Design
125 986	Cl.	06-06	3 Design
125 987	Cl.	07-02	2 Design
125 993	Cl.	10-02	1 Design
125 997	Cl.	10-07	1 Design
125 999	Cl.	11-01	3 Design
126 000	Cl.	11-02	1 Design
126 001	Cl.	14-02	2 Design
126 002	Cl.	14-02	2 Design
126 004	Cl.	17-03	1 Design
126 005	Cl.	19-02	1 Design
126 009	Cl.	23-03	1 Design
126 012	Cl.	25-01	3 Design
126 015	Cl.	01-03	1 Design
126 016	Cl.	02-07	6 Design
126 017	Cl.	03-99	1 Design
126 020	Cl.	06-01	8 Design
126 021	Cl.	26-05	3 Design
126 022	Cl.	06-03	2 Design
126 032	Cl.	08-03	1 Design
126 034	Cl.	10-02	1 design
126 035	Cl.	10-02	3 design
126 036	Cl.	10-02	4 Design
126 037	Cl.	10-02	2 Design
126 038	Cl.	10-07	3 Design
126 046	Cl.	19-02	1 Design
126 047	Cl.	19-08	1 Design
126 049	Cl.	20-03	1 design
126 050	Cl.	21-01	72 Design
126 056	Cl.	25-01	1 Design
126 072	Cl.	14-03	1 Design
126 086	Cl.	03-99	1 design
126 088	Cl.	06-01	3 Design
126 089	Cl.	06-01	1 design
126 112	Cl.	12-12	1 design
126 126	Cl.	21-01	1 design
126 127	Cl.	21-01	1 design
126 131	Cl.	23-02	1 design
126 140	Cl.	29-02	1 Design
126 168	Cl.	21-01	1 Design

Cl. 05-05

131 068

10.09.2004



a



b



c



d



e



f





g

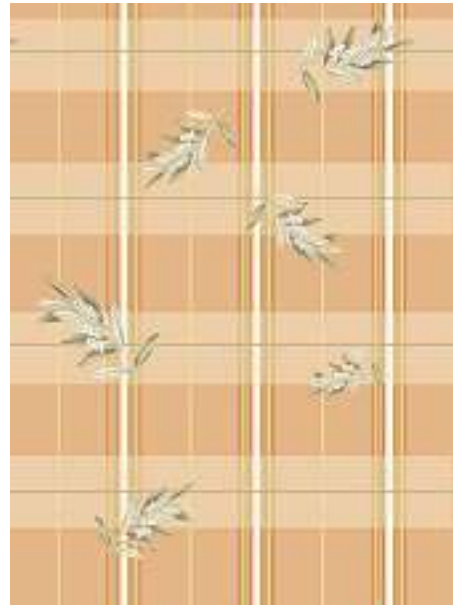

j



h



k



i



l

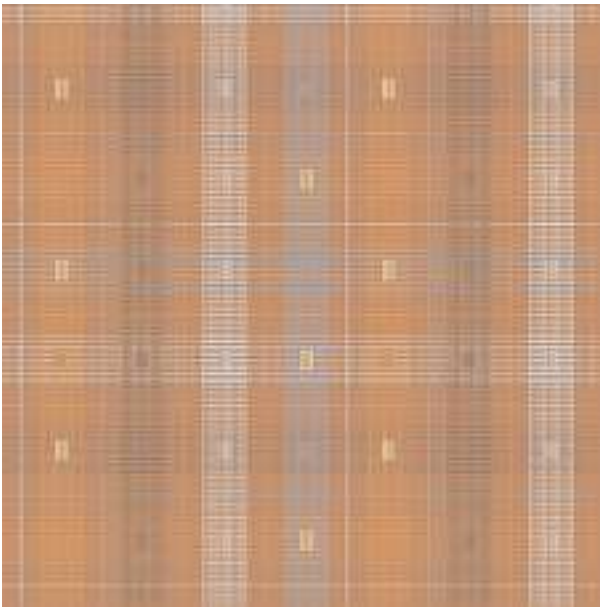

m



p

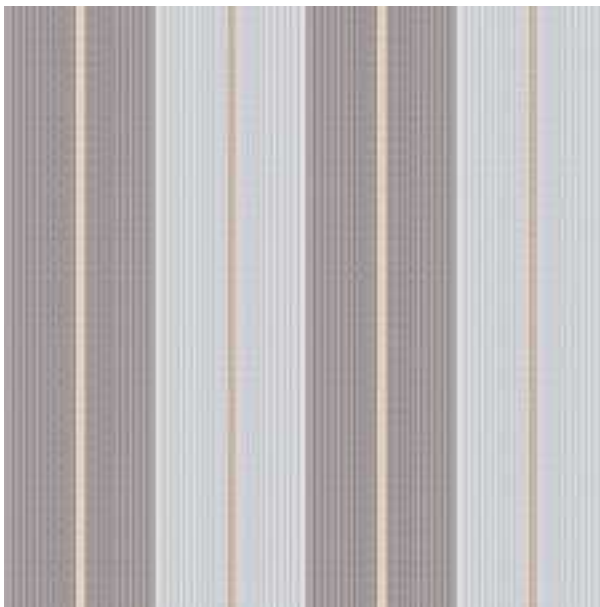

n



q

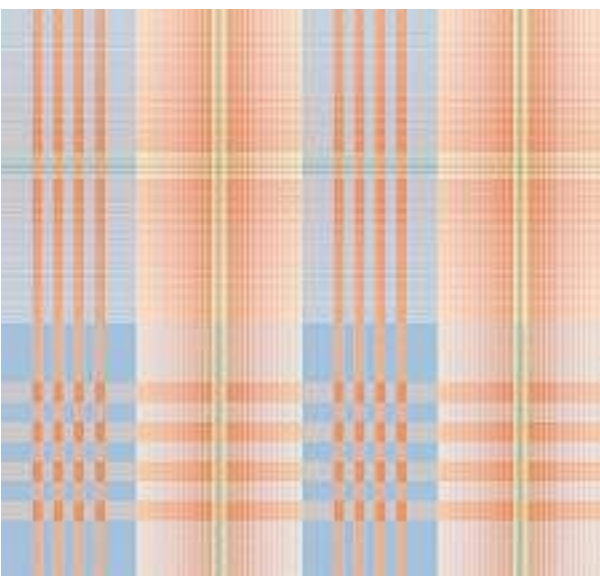

o



r

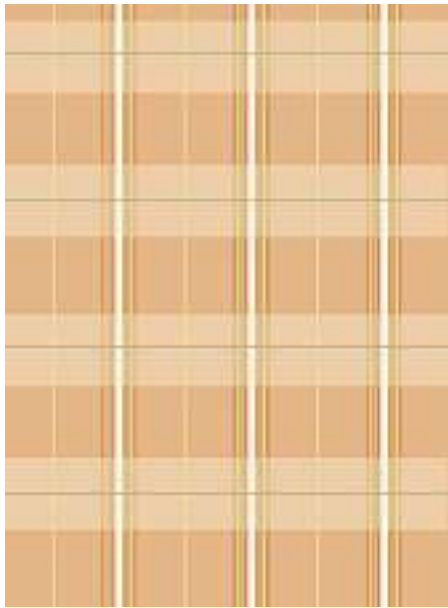

s



t



u

Cl. 05-05

131 069

16.09.2004



300423 - 1



300423 - 2

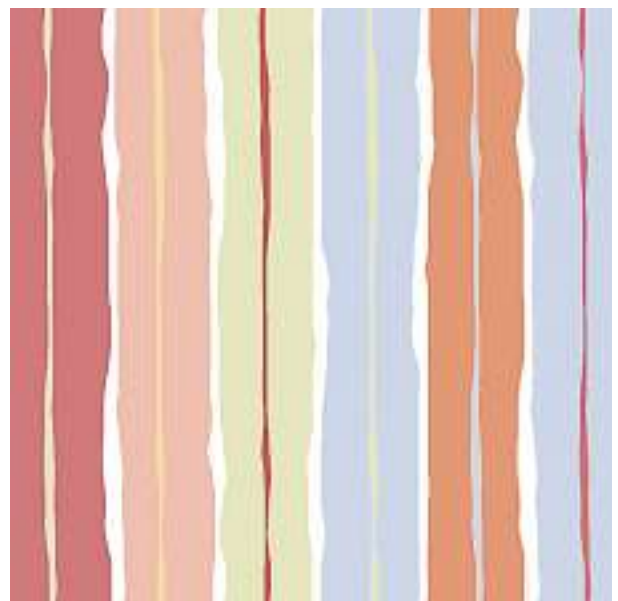

300423 - 3



300423 - 4

Cl. 06-01                      **131 070**                      09.09.2004



K-D-50130-CH/1



K-D-50130-CH/2

Cl. 20-02                      **131 097**                      10.09.2004



1



2

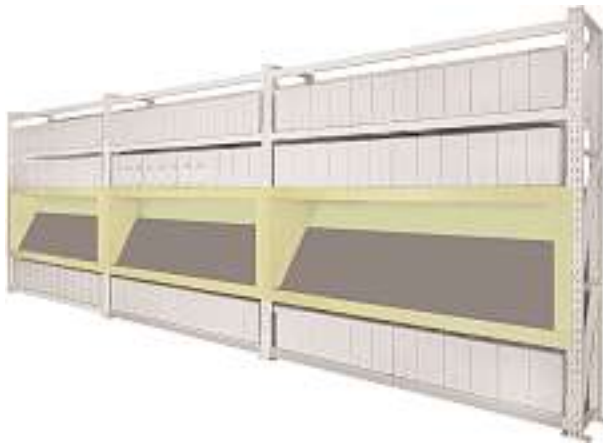

3

Cl. 21-01

131 101

23.09.2004

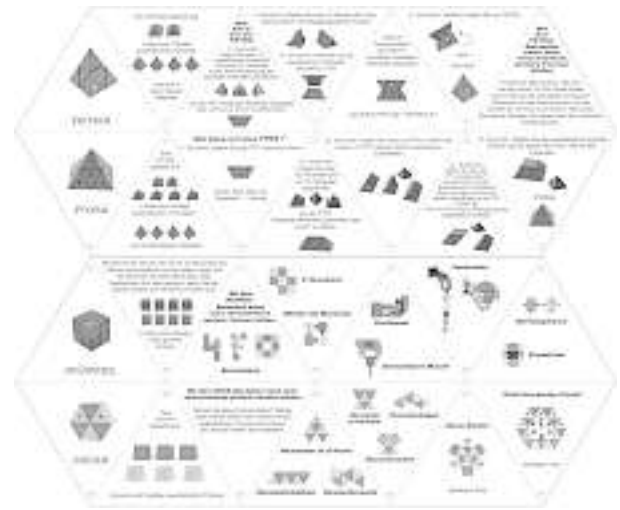

1



2

Cl. 21-01 131 103 13.10.2004  
4 design – mascottes  
Déposant: NOVAE HOLDING SA, c/o Anagest SA,  
Route de Moncor 2, 1752 Villars-sur-Glâne  
Designer: David Haefeli, Vevey  
Mandataire: Inteltech SA, 2001 Neuchâtel



1



2



3



4