

Nationale Hinterlegungen

In der folgenden Liste werden die beim Eidgenössischen Institut für Geistiges Eigentum hinterlegten Designs publiziert. Dabei sind der Reihe nach angegeben:

- internationale Klassenangaben
- Hinterlegungsnummer
- Hinterlegungsdatum
- Allenfalls Aufschub der Veröffentlichung
- Anzahl der hinterlegten Designs
- Bezeichnung
- Name und Wohnsitz des Hinterlegers oder der Hinterlegerin
- gegebenenfalls Name und Wohnsitz des Designers oder der Designerin
- Name und Geschäftssitz des allfälligen Vertreters oder der Vertreterin
- gegebenenfalls Prioritätsangaben
- gegebenenfalls Beschreibungstext
- Ordnungsnummer
- Reproduktion des Designs

Internationale Hinterlegungen

Die bei der Weltorganisation für geistiges Eigentum in Genf hinterlegten Muster und Modelle mit Benennung Schweiz geniessen den gleichen Schutz wie national hinterlegte Designs. Sie werden jeweils im Blatt «Bulletin des dessins et modèles internationaux» veröffentlicht. Dieses Publikationsorgan ist deshalb für eine vollständige Recherche unbedingt beizuziehen.

Topographien

Angaben über die vom Eidgenössischen Institut für Geistiges Eigentum eingetragenen Topographien von Halbleitererzeugnissen werden in folgender Anordnung aufgeführt:

- Eintragsnummer
- Anmeldedatum
- Bezeichnung
- Name und Wohnsitz des Anmelders oder der Anmelderin
- gegebenenfalls Name und Wohnsitz des Herstellers oder der Herstellerin
- Name und Geschäftssitz des oder der allfälligen Bevollmächtigten
- Datum und Ort einer allfälligen ersten geschäftlichen Verbreitung der Topographie

Dépôts nationaux

Les designs déposés à l'Institut Fédéral de la Propriété Intellectuelle sont publiés dans la liste qui suit. Les indications y relatives sont mentionnées dans cet ordre:

- indications des classes internationales
- numéro de dépôt
- date de dépôt
- le cas échéant, ajournement de la publication
- nombre des designs déposés
- désignation
- nom et domicile du/de la déposant/e
- le cas échéant, nom et domicile du/de la designer
- nom et domicile de l'éventuel/le mandataire
- le cas échéant, indication de priorité
- le cas échéant, description du design
- numéro attribué à chaque design
- reproduction du design

Dépôts internationaux

Les dessins et modèles déposés à l'Organisation Mondiale de la Propriété Intellectuelle à Genève qui désignent la Suisse jouissent de la même protection que les dépôts nationaux. Ils sont chaque fois publiés dans la feuille «Bulletin des dessins et modèles internationaux». Pour une recherche complète, il est indispensable de consulter ledit organe de publication.

Topographies

Les indications concernant les topographies des produits semi-conducteurs, enregistrées par l'Institut Fédéral de la Propriété Intellectuelle, sont énumérées dans l'ordre suivant:

- numéro d'enregistrement
- date de dépôt
- désignation
- nom et domicile du/de la déposant/e
- le cas échéant, nom et domicile du/de la producteur/trice
- nom et domicile de l'éventuel/le mandataire
- date et lieu d'une éventuelle première mise en circulation de la topographie

Depositi nazionali

Nella lista seguente vengono pubblicati i design depositati presso l'Istituto Federale della Proprietà Intellettuale. Sono menzionati nel seguente ordine:

- indicazioni delle classi internazionali
- numero di deposito
- data del deposito
- se del caso, indicazione che la pubblicazione è stata differita
- numero dei design depositati
- designazione
- nome e domicilio del depositante
- se del caso, nome e domicilio del designer
- nome e sede di un eventuale mandataro
- se del caso, indicazioni di priorità
- se del caso, descrizione del design
- numero d'ordine
- riproduzione del design

Depositi internazionali

I disegni e modelli depositati presso l'Organizzazione Mondiale della Proprietà Intellettuale a Ginevra con denominazione Svizzera godono della medesima protezione del deposito nazionale. Essi vengono pubblicati ogni volta nel foglio «Bulletin des dessins et modèles internationaux». Quest'organo di pubblicazione è da consultare se si vuole effettuare una ricerca completa.

Topografie

Le indicazioni concernenti le topografie di prodotti a semiconduttori depositati presso l'Istituto Federale della Proprietà Intellettuale sono menzionate nell'ordine seguente:

- numero di registrazione
- data del deposito
- designazione
- nome e domicilio del/la richiedente
- se del caso, nome e domicilio del/la produttore/trice
- nome e sede di un eventuale mandataro
- data e luogo di un'eventuale prima messa in circolazione della topografia

Hinterlegungen
Dépôts
Deposit

Cl. 02-01 **130 657** 27.04.2004
 2 Design – Hemdenkragen
 Hinterleger: Rico Herold, Monbijoustrasse 75, 3007 Bern

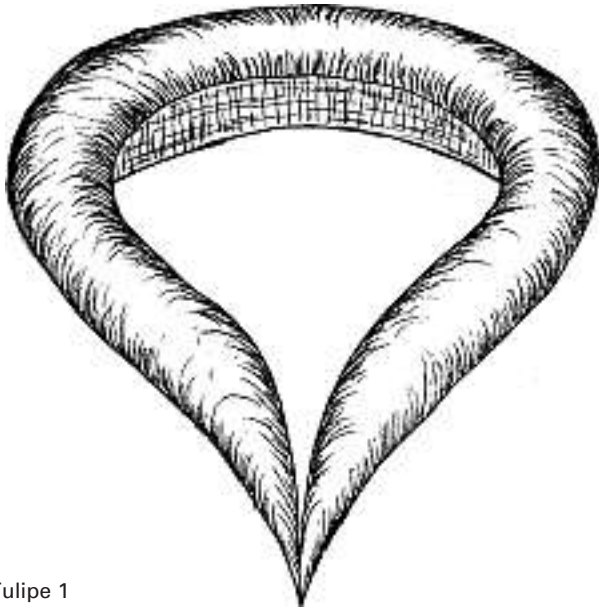

Tulipe 1



Tulipe 2

Cl. 02-02 **130 658** 15.04.2004
 2 Design – Brandschutzkleidung
 Hinterleger: CONSULTIV AG, Wieshofstrasse 117,
 8408 Winterthur
 Designer: Ivo Ernst, Egg

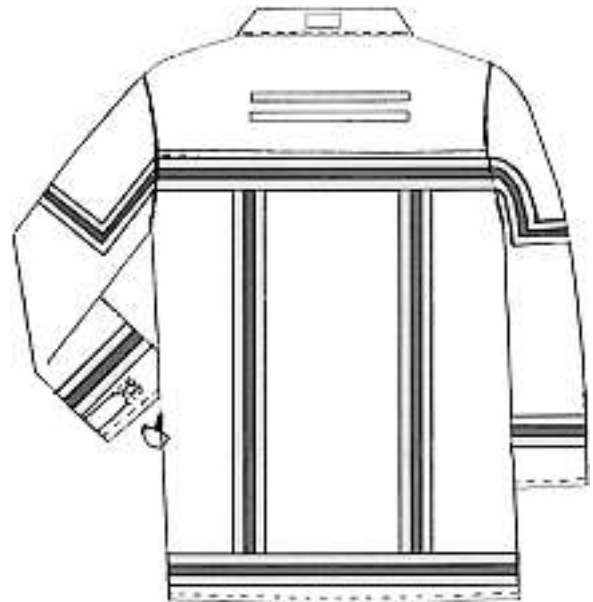

BSJ FLS

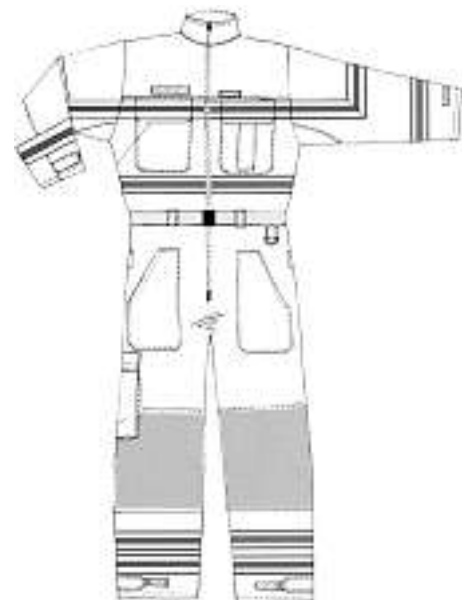

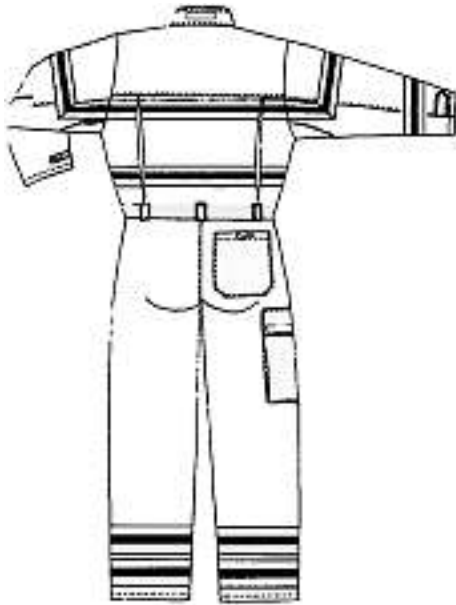

BSK FLS

Cl. 03-01 **130 659** 13.04.2004
 1 Design – Tasche
 Hinterleger: winter und partner, Mühlemattstrasse 15
 4112 Bättwil
 Designer: Tobias Winter, Baar

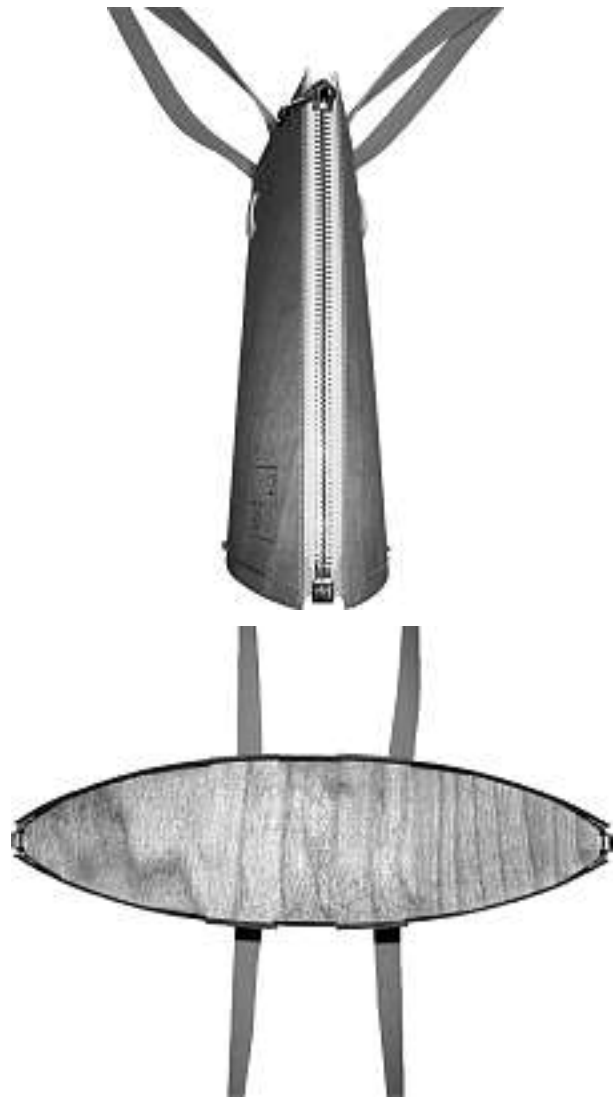

01 bag

Cl. 03-01 **130 660** 14.04.2004
 3 design – écrins pour montres, support interne pour écrins
 pour montres
 Déposant: Underwood S. A., Route de la Clochette 5
 1052 Le Mont-sur-Lausanne
 Designer: Alessandro Rustioni, Vallina - Bagno a Ripoli
 Mandataire: Griffes Consulting S.A., 1206 Genève





MO-56528-CH



MO-56527-CH



MO-56529-CH

Cl. 03-01 **130 661** 21.04.2004
 1 Design – Accessoires Bemusterung
 Hinterleger: Cindy Schmid, Balma, 7132 Vals

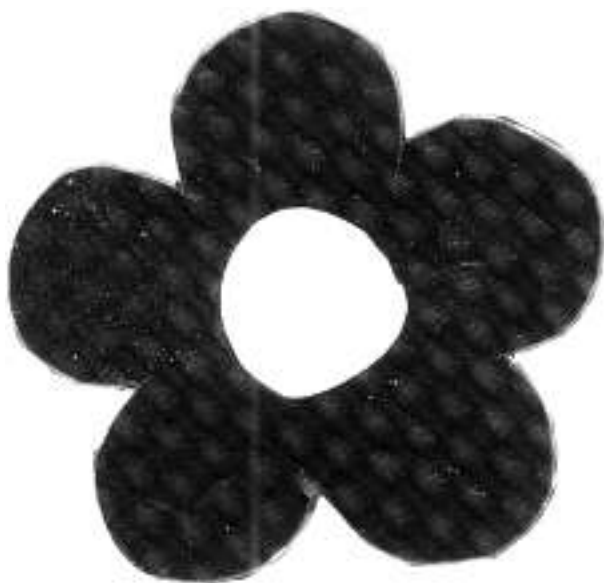

1 Blume

Cl. 06-01 **130 662** 20.04.2004
 4 Design – Stühle
 Hinterleger: Vitra Patente AG
 Klünenfeldstrasse 22, 4132 Muttenz
 Designer: Alberto Meda, Milano
 Vertreter: AXON Patent GmbH, 4147 Aesch





1



2



3





4

Cl. 06-01 **130 663** 22.04.2004
 1 Design – Stuhl
 Hinterleger: G-Collection GmbH, Landstrasse 4
 6418 Rothenthurm
 Designer: Pirmin Lüönd, Rothenthurm



53.96



Cl. 06-04 **130 664** 14.04.2004
 2 Design – CD-Gestell
 Hinterleger: Stefan Lenherr, Vorburgweg 1571, 9473 Gams
 Andreas Dörig, Alpsteinstrasse 3, 9323 Steinach
 Vertreter: Stefan Lenherr, 9473 Gams
 Beschreibung des Designs: Das Whirligigskid ist ein in Grösse und Ausführung völlig flexibles Archivierungssystem für CD's oder DVD's. Es ist erweiterbar und kann etagenweise zusammengebaut werden. Das Karussell in modernem Design benötigt wenig Platz, bietet aber viel Raum für die Datenträger. So kann je nach Bedarf ein Gestell von 36 bis 1320 CD's geliefert werden. Dank der guten Übersicht der CD's im Whirligigskid finden Sie Ihre Silberlinge im Handumdrehen. Ein stabiler Kugellagering sorgt für eine einfache Bedienung.
 Die Standardausführung der Teller ist Birkenperrholz und die Verbindungstangen in ALU. Es kann auch in farbiger MDF, diversen Massivhölzern, Acrylglas oder in Kunststoff geliefert werden.

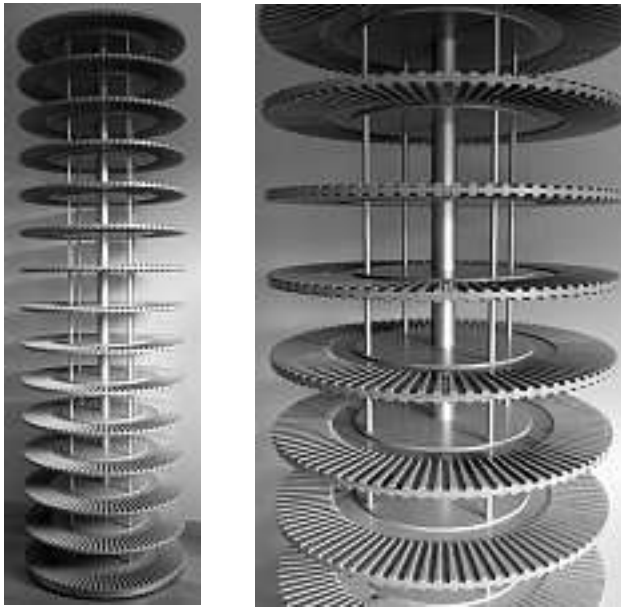

1



2

Cl. 06-04 **130 665** 20.04.2004
 1 Design – Regal/Sitzmöbel
 Hinterleger: Kurt Spalinger, via Buonamano 19, 6612 Ascona



brsm_04

Cl. 06-04 **130 666** 24.04.2004
 2 Design – Aufbewahrungsbehälter
 Hinterleger: PRM TEC AG, Arinstrasse 41, 9475 Sevelen
 Designer: Mathias Pirchl, Birrwil; Franz Mathis, Buochs;
 Gerhard Pirchl, Wangs
 Vertreter: Luchs & Partner, Patentanwälte, 8002 Zürich
 Priorität: DE, 24.10.2003





P149-M1-CH.1





Cl. 06-06 130 667 14.04.2004
1 Design – Verbindungselement
Hinterleger: Hans Wirth, Hauptstrasse 158, 8762 Schwanden

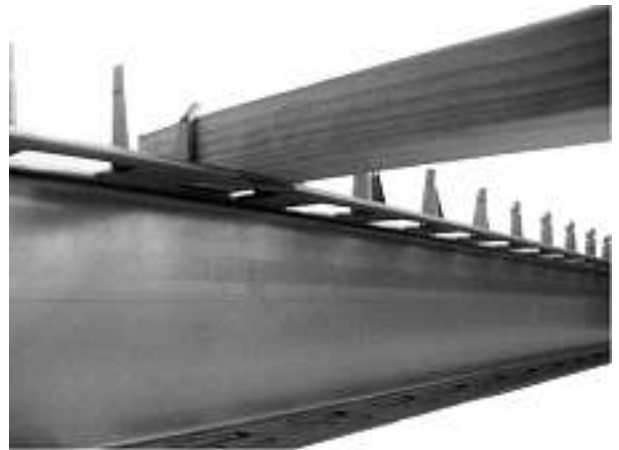
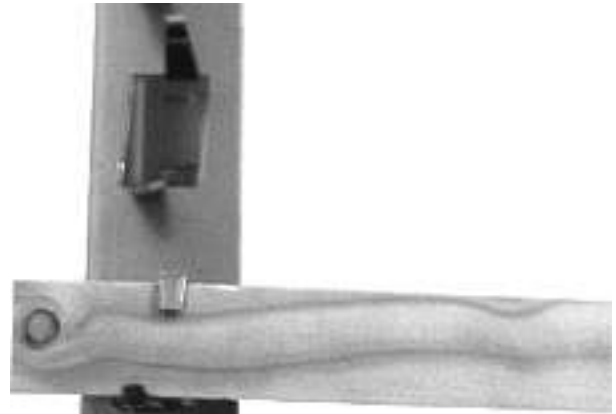

Cl. 08-99 130 668 28.04.2004
2 Design – Pflanzengitter
Hinterleger: Kurt Zimmerli, Dorfstrasse 5, 8532 Warth



Green Tower 1

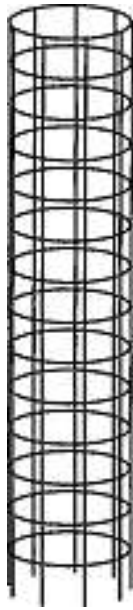

Green Tower 2

Cl. 09-05 130 669 20.04.2004
10 Design – Verpackungsbemusterung
Hinterleger: Flexiplast Verpackungen GmbH, Bohlstrasse 22
8355 Aadorf
Designer: Daniel Hansmann, Aadorf
Vertreter: Dr. Schneider & Partner AG, Intellectual Property
Rights, 8027 Zürich



1

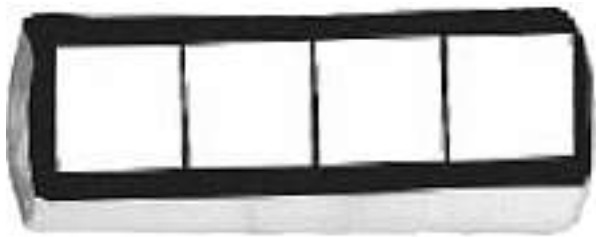

2



3



4



5

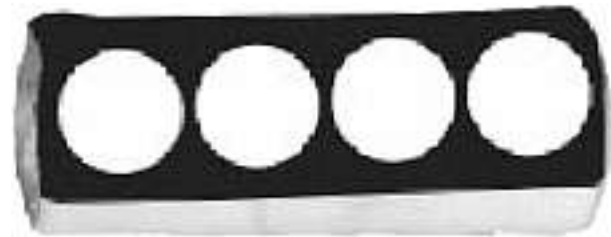

6

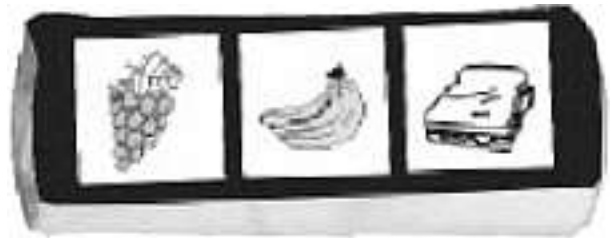

7



8



9



10

Cl. 09-05 130 670 27.04.2004

2 design – emballages
Déposant: Pakerman S.A., Rue de Saint-Léger 28
1204 Genève
Designer: Eric Risgalla, Genève
Mandataire: William Blanc & Cie, Conseils en Propriété
Industrielle S.A., 1220 Les Avanchets/Genève

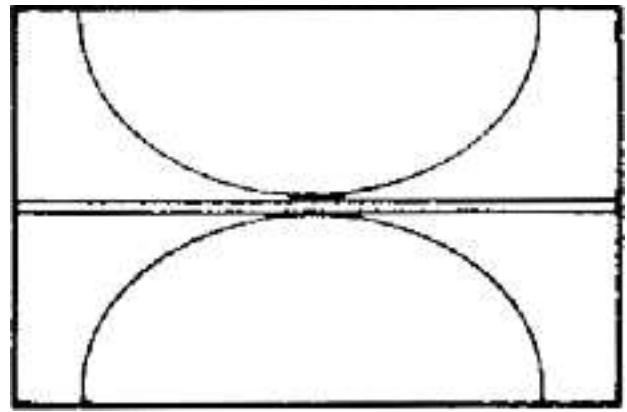
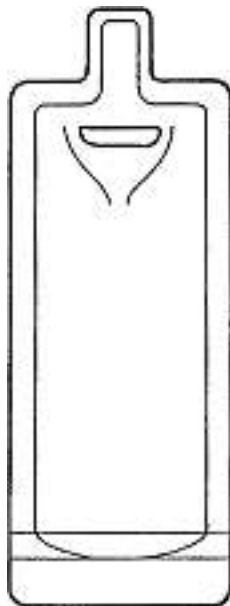
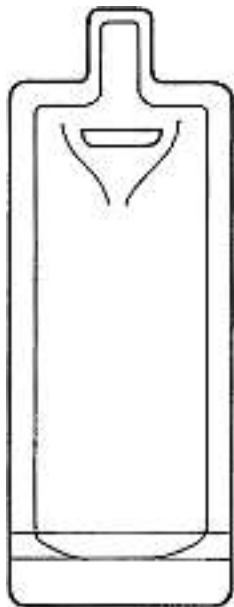
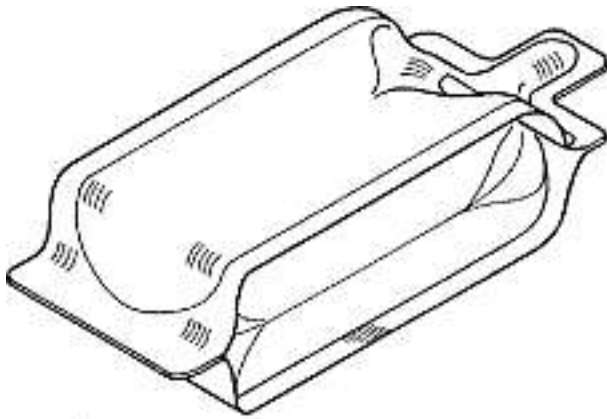

D-15004 CH-1

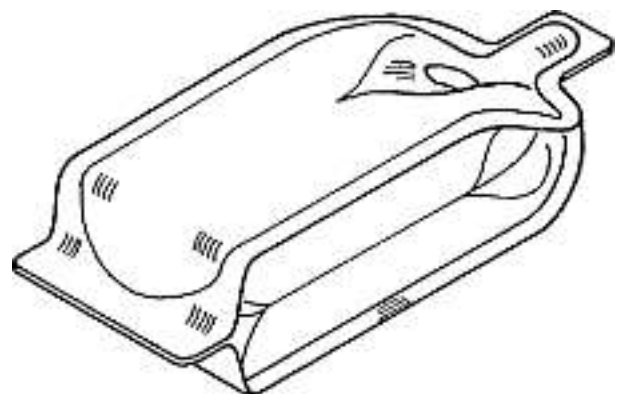
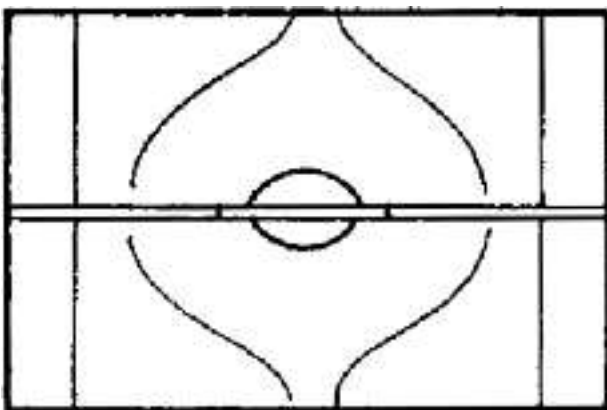

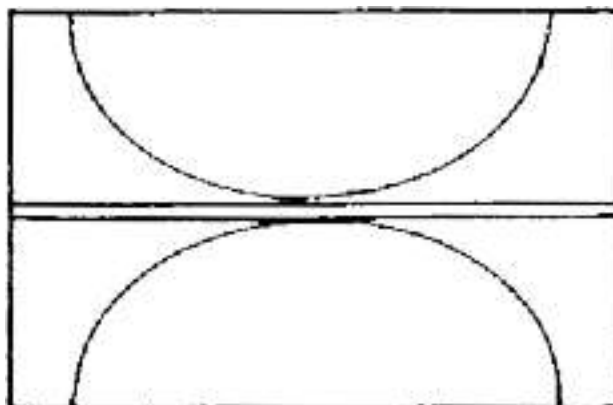
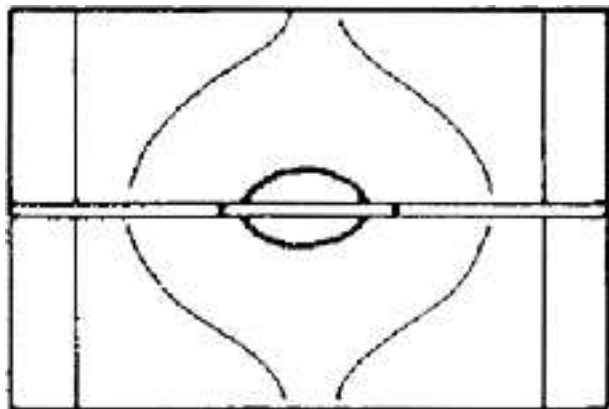
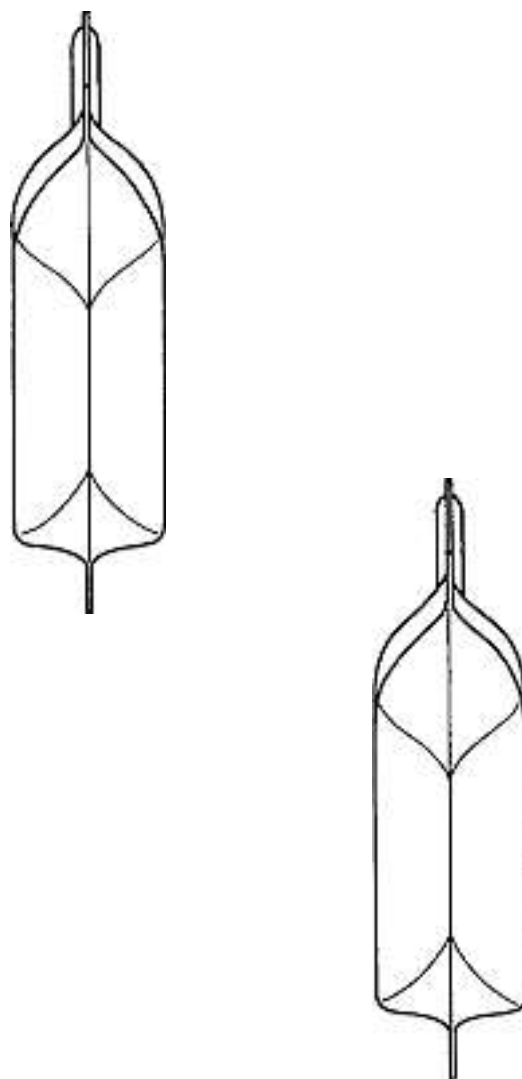
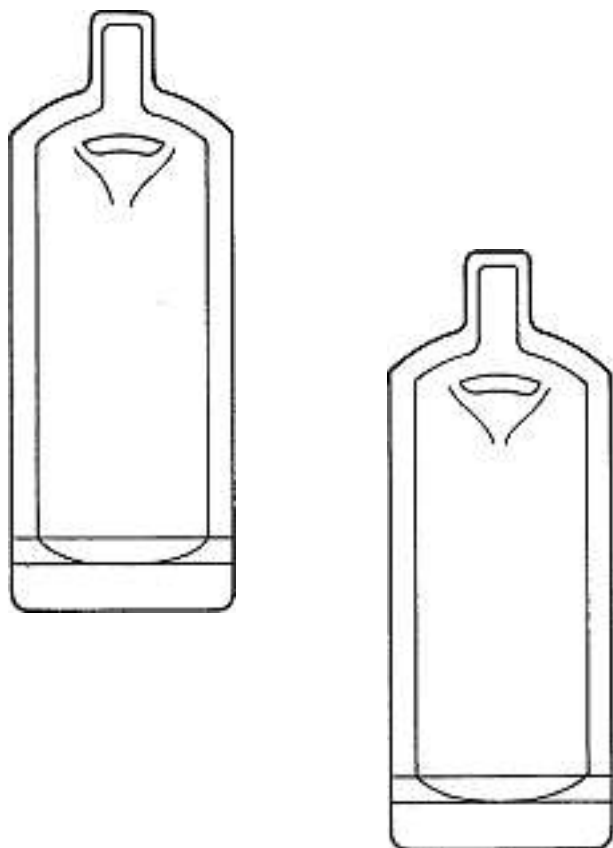

D-15004 CH-2

Cl. 09-09

130 671

23.04.2004

3 design – dispositif de stockage

Déposant: Sangenic International Limited, Dudley Lane,
Cramlington, Northumberland NE23 7RH, GB

Designer: Mark Armstrong, London; Ian Webb, London

Mandataire: Kirker & Cie S.A., Ingénieurs-Conseils

1226 Genève - Thônex

Priorité: EM, 23.10.2003

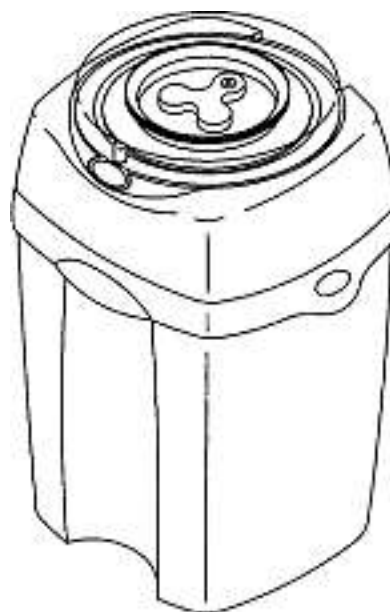

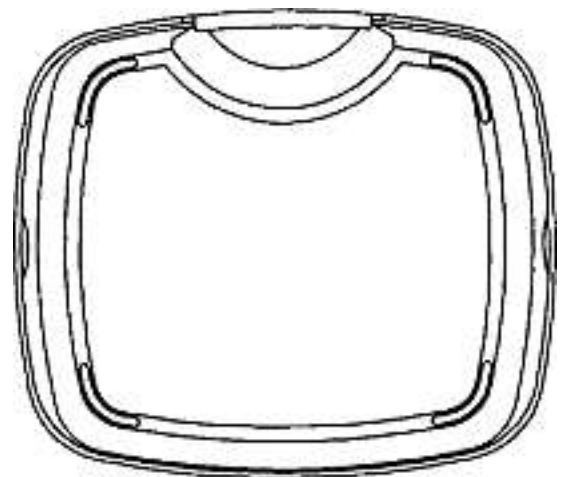
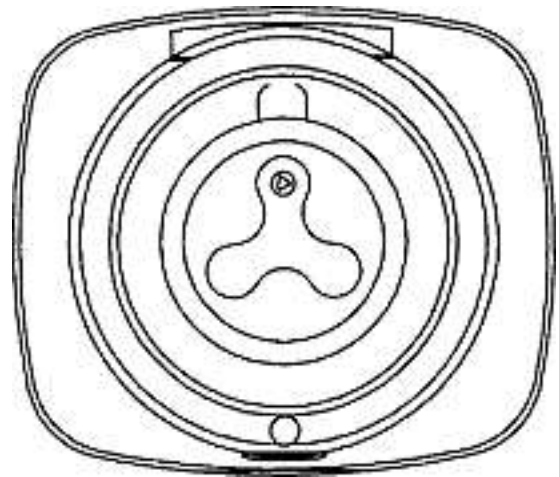
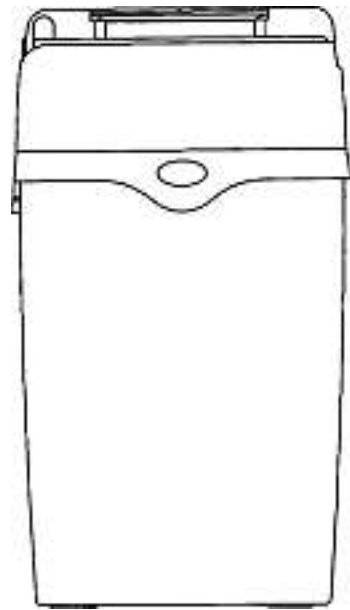
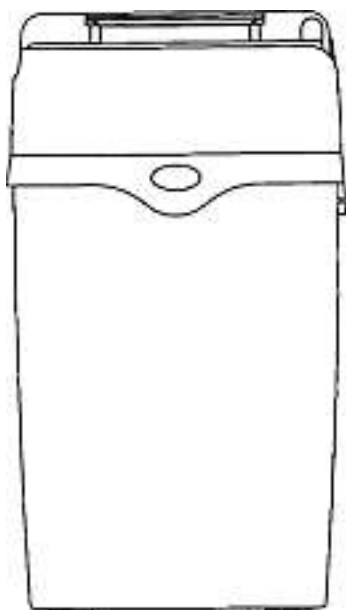
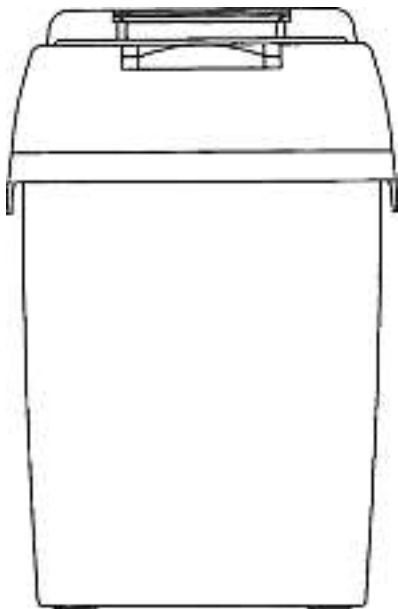
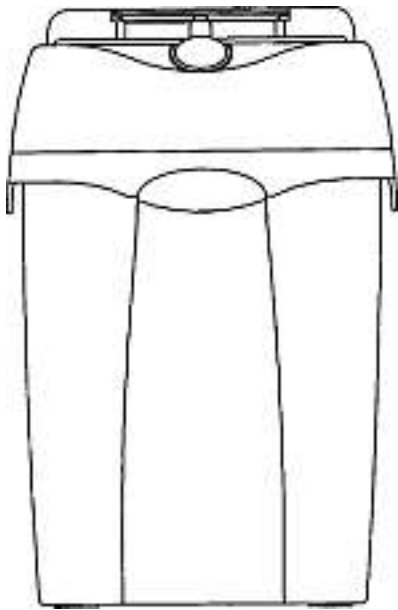

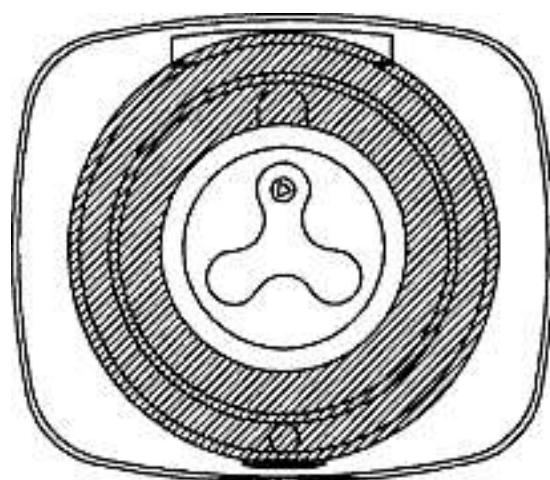
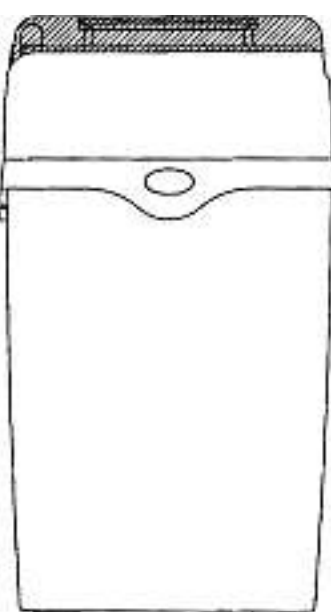
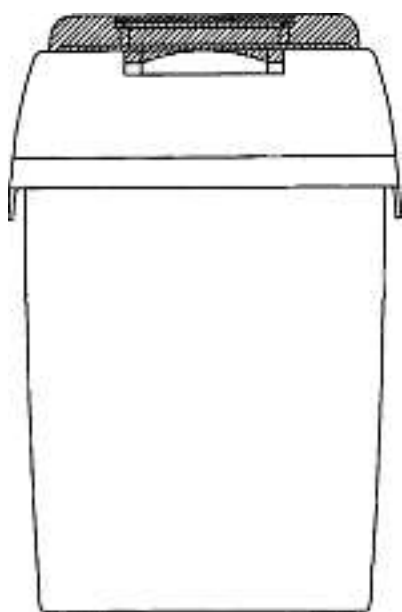
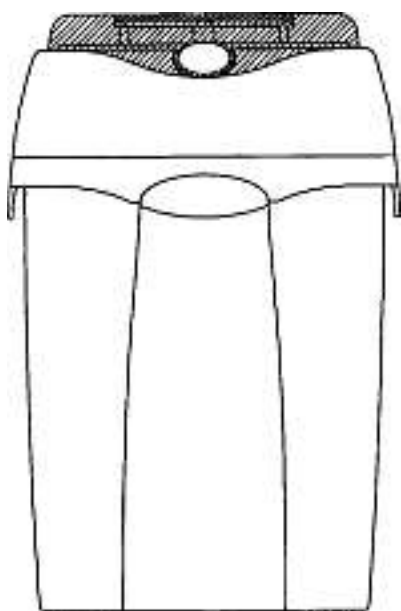
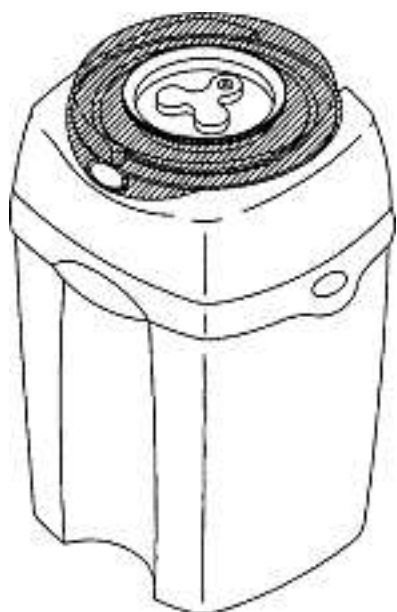

2

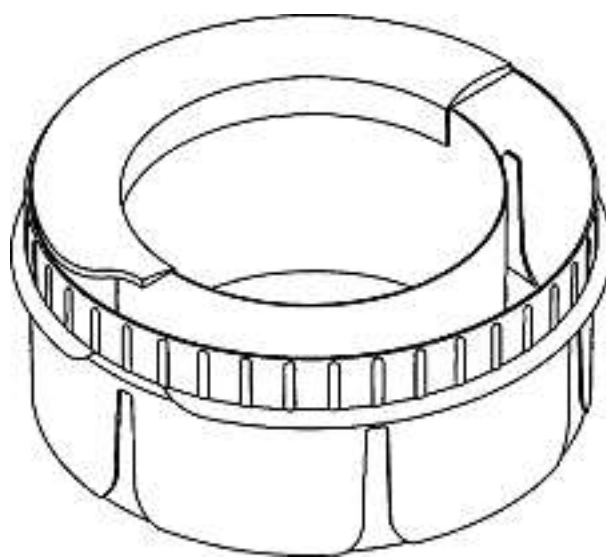

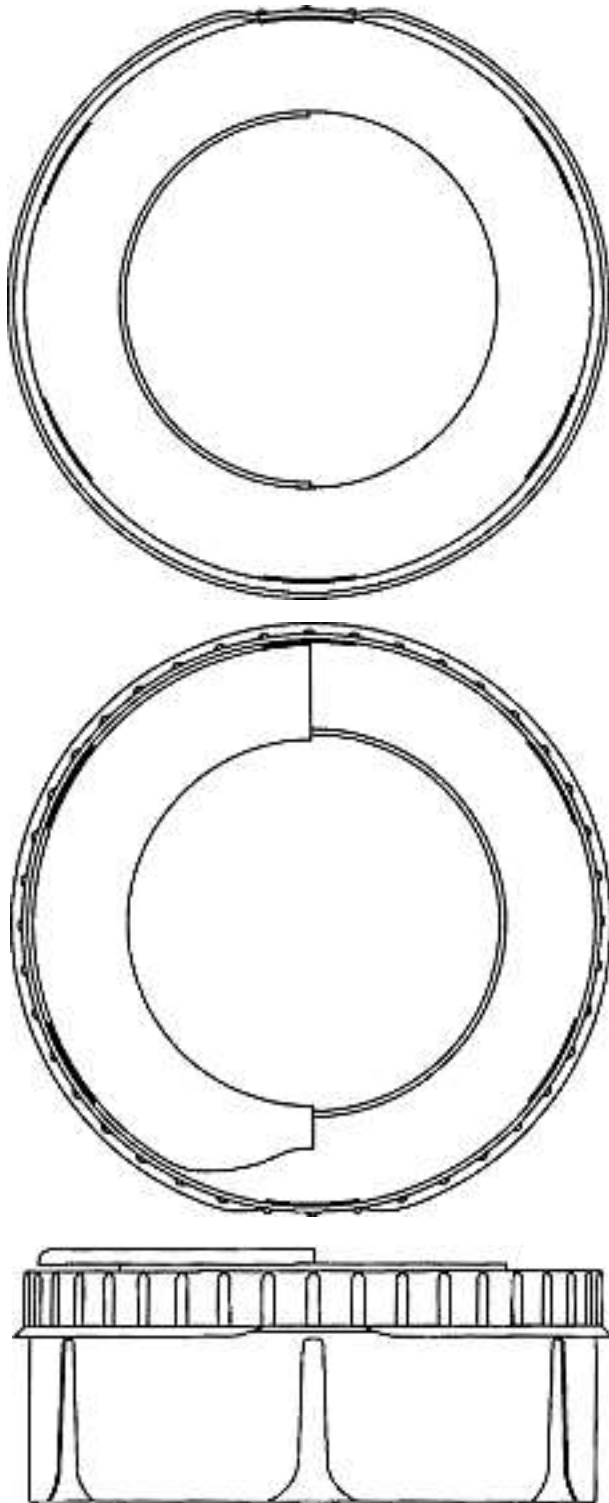

3

Cl. 10-02, 10-07 **130 672** 19.04.2004
 7 design – boîtes, cadrans, boucle, couronne
 Déposant: Paul Gisimundo, 12, chemin de Tivoli
 1213 Petit-Lancy



EP (éphèse-1)



EP (éphèse-2)



RD (rode)



O (olympie)



C1 Couronne



B Boucle et ardillon



A1 Boucle et ardillon

Cl. 10-06 130 673 16.04.2004
 1 Design – Verkehrssignalteil
 Hinterleger: Volker Schloms
 Rosswiserstrasse 30, Frastanz, AT
 Designer: Richard Schloms, Sennwald
 Vertreter: Luchs & Partner, Patentanwälte, 8002 Zürich



1

Cl. 10-06 130 674 20.04.2004
 3 Design – Strassensignal-Halterung
 Hinterleger: Markus Rufer, Kirchweg 18, 3122 Kehrsatz
 Vertreter: Fuhrer Marbach & Partner, 3007 Bern



450848/225-CH-MOD40/1



450848/225-CH-MOD40/2



450848/225-CH-MOD40/3

Cl. 10-07 **130 675** 13.04.2004
 31 Design – Uhrenarmband
 Hinterleger: Hirsch Holding (Schweiz) AG, Nidaugasse 15
 2502 Biel/Bienne
 Designer: Markus Kerker, Techelsberg a. Wörthersee

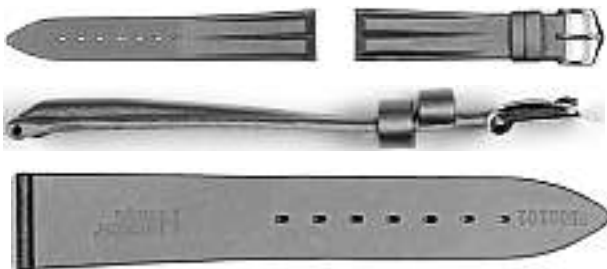

05 001 01



05 009 01

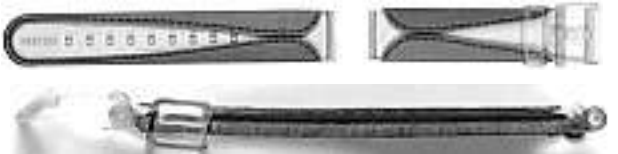

05 013 01



05 016 01



05 018 01



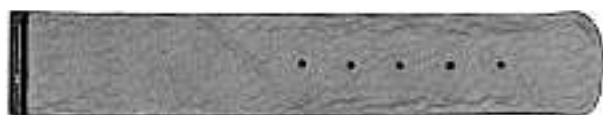

05 019 01



05 021 01



05 022 01



05 023 01



05 026 01

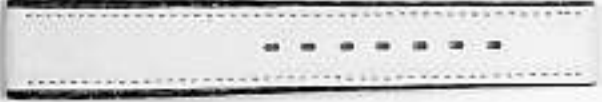

05 027 01



05 028 01

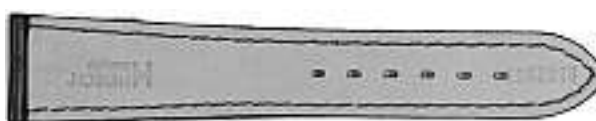

05 029 01



05 031 01



05 032 01



05 033 01



05 034 01



05 036 01



05 037 01



05 038 01

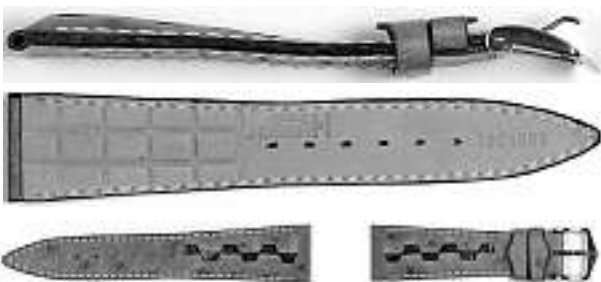

05 040 01



05 041 01



05 042 01

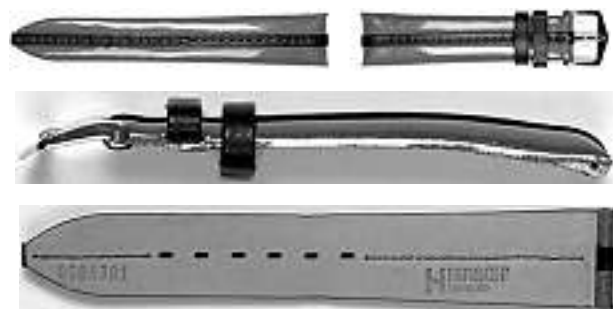

05 043 01





05 045 01



05 046 01



05 047 01



05 048 01



05 049 01

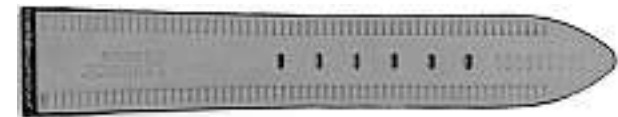

05 21 001 01



05 31 001 01

Cl. 10-07 **130 676** 14.04.2004
 4 design – compteur pour cadran de montre, élément décoratif pour montre, cadran monté sur un mouvement de montre, aiguille pour montre
 Déposant: Ideò Tempo SA, Rue du Lac 11, 1007 Lausanne
 Designer: Philippe Subilia, Lausanne
 Mandataire: Griffes Consulting S.A., 1206 Genève



MO-56028-CH



MO-56029-CH



MO-56030-CH



MO-56031-CH

Cl. 10-07 **130 677** 15.04.2004
 1 design – boîte de montres
 Déposant: Montres Fargues Sàrl, Rue de Malagny 13
 Case postale 426, 1196 Gland
 Designer: Arnaud Fargues, Gland

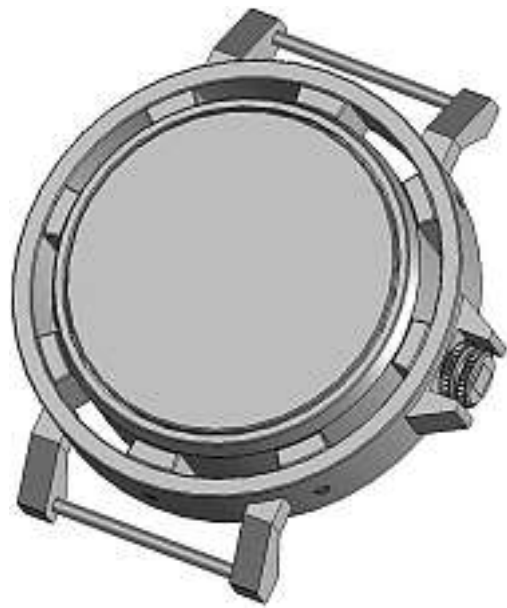
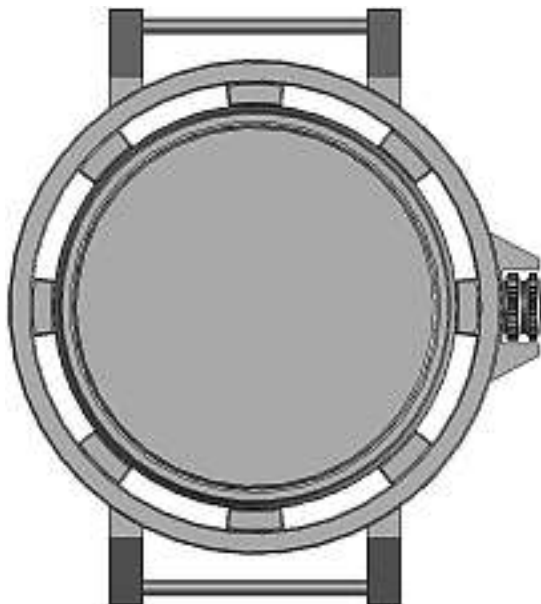

AF04

Cl. 11-01 **130 678** 28.04.2004
 1 design – pierre précieuse
 Déposant: Guy Hadad, 54 Bezael Street, Diamond Building,
 Room 369, Ramat Gan, IL
 Mandataire: SEDIN SA, 1207 Genève
 Priorité: IL, 29.01.2004

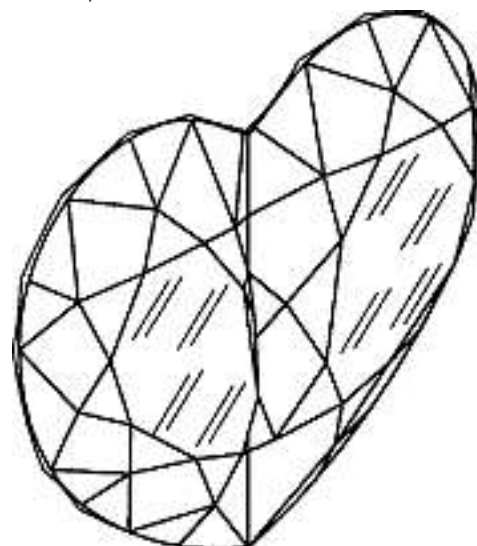

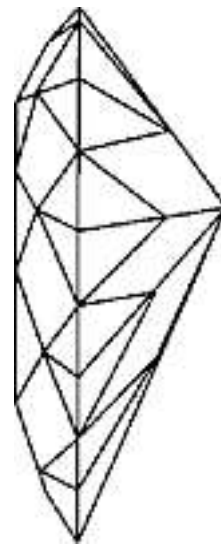
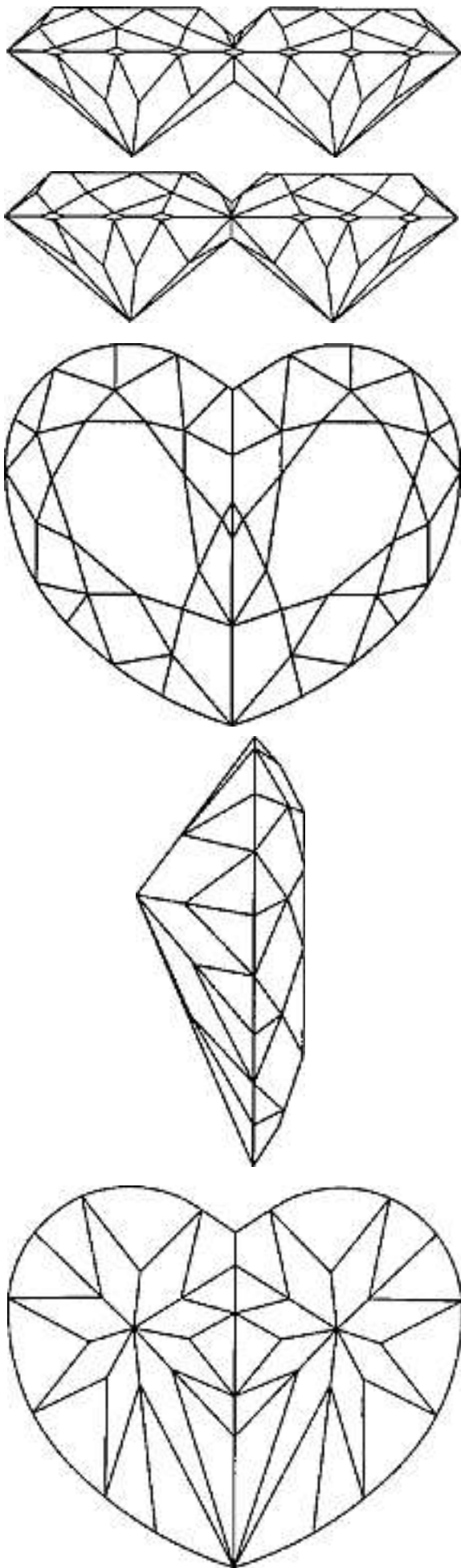

CH/DP/032004

Cl. 11-01 **130 679** 30.04.2004
 29 Design – Schmuckstücke (Fingerringe / Anhänger / Ohrclipstecker)
 Hinterleger: Meister + Co AG, Hauptstrasse 66, 8832 Wollerau
 Designer: Silvio Daldini, Kilchberg ZH

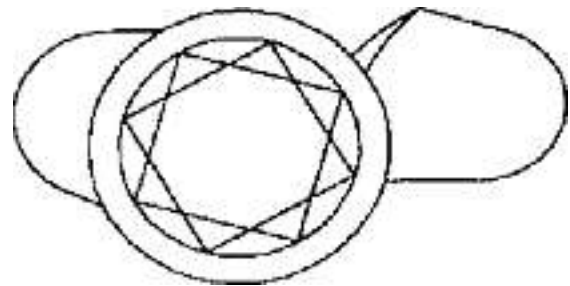

1

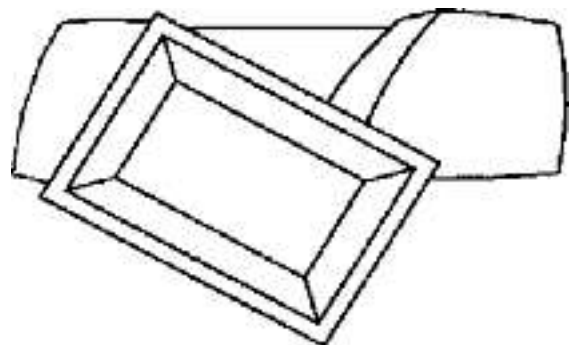

2

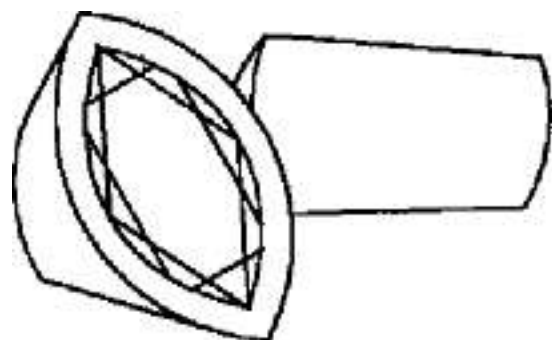

3

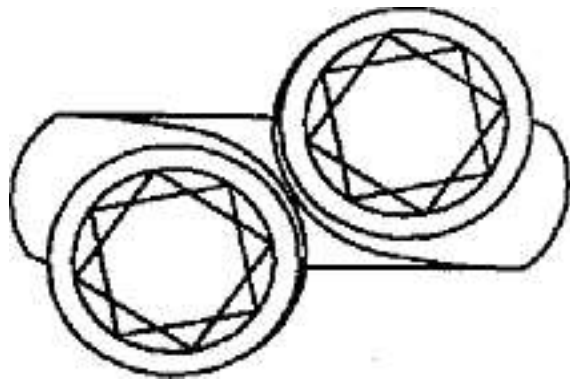

4

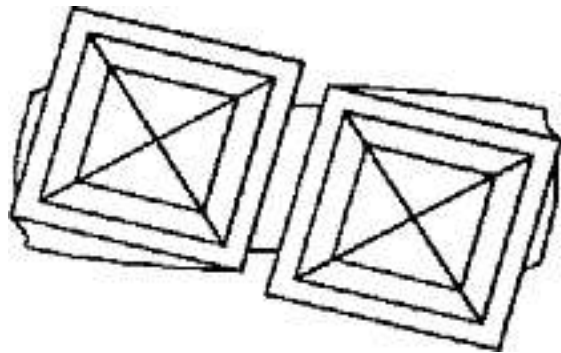

5

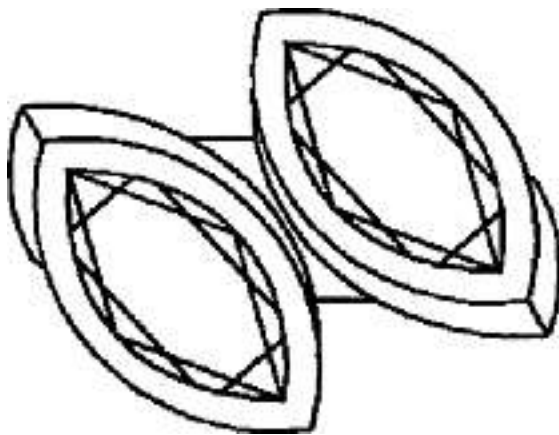

6

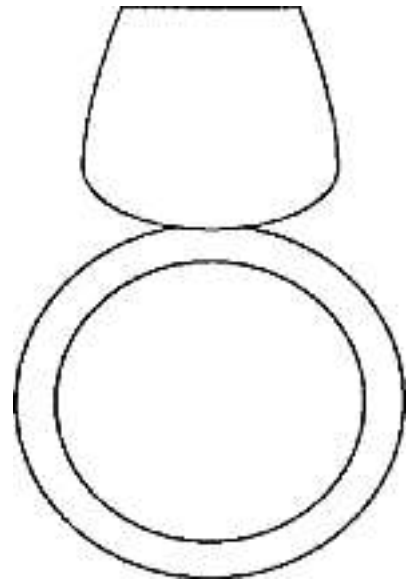
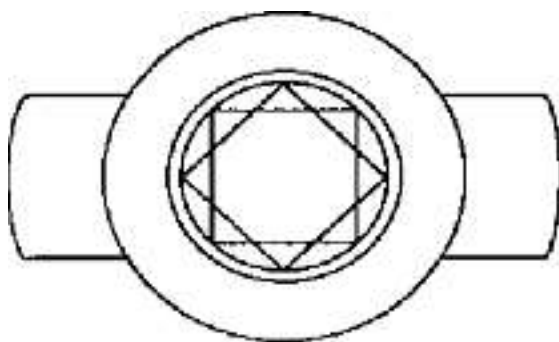

7

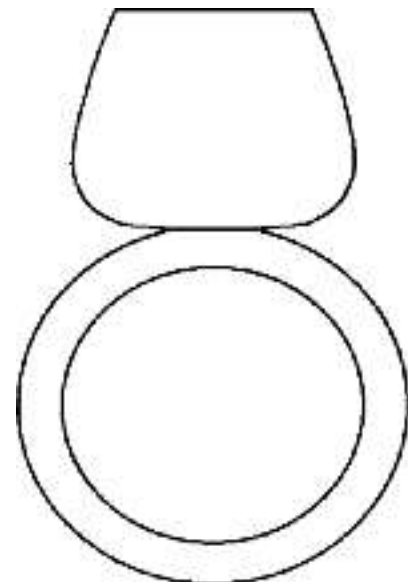
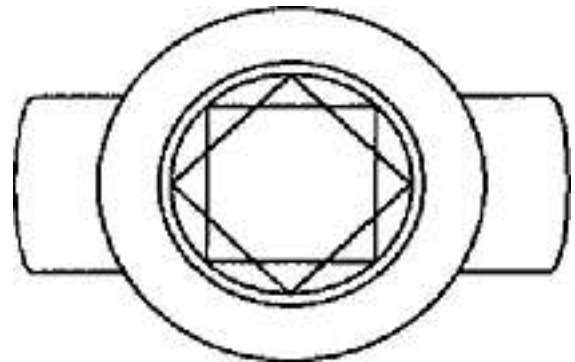

8

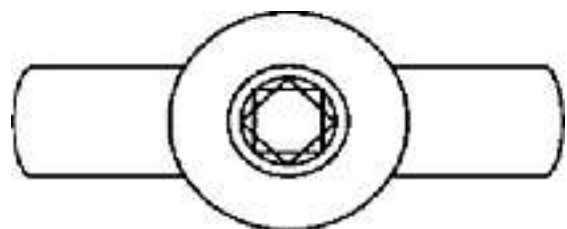

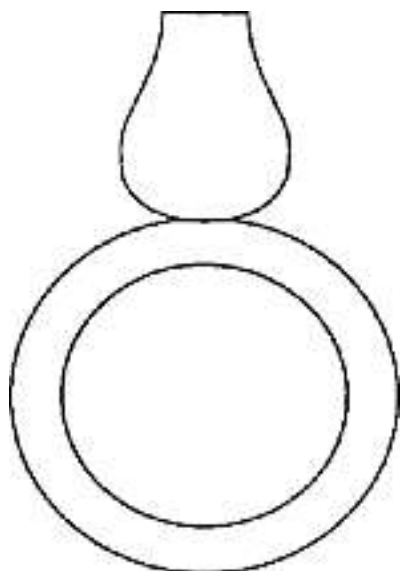

9

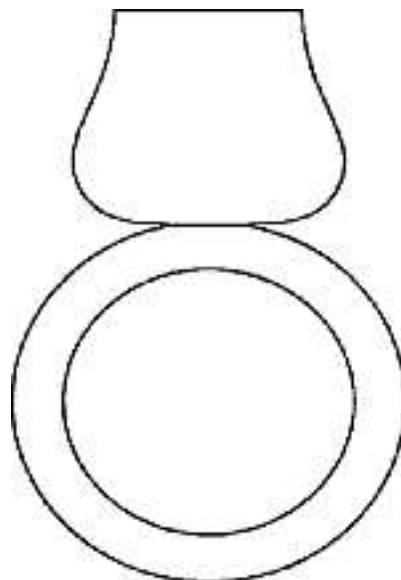
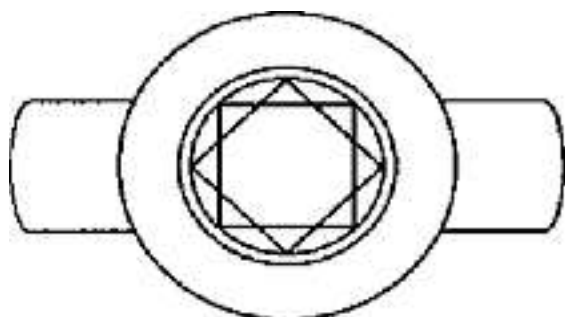

11

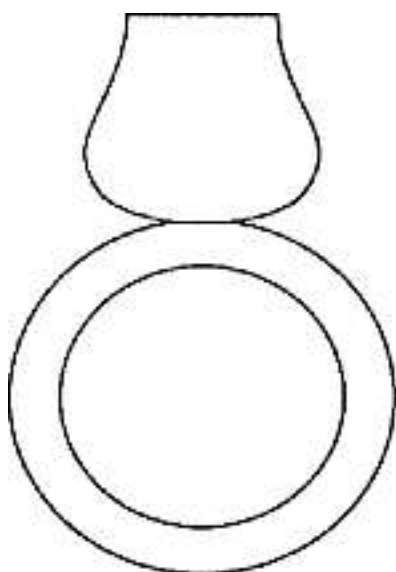
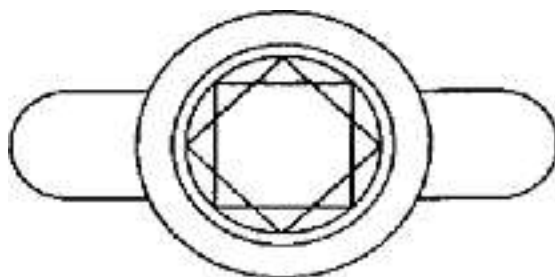

10

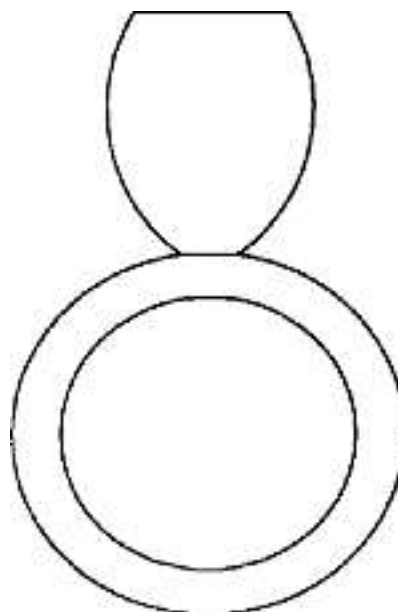
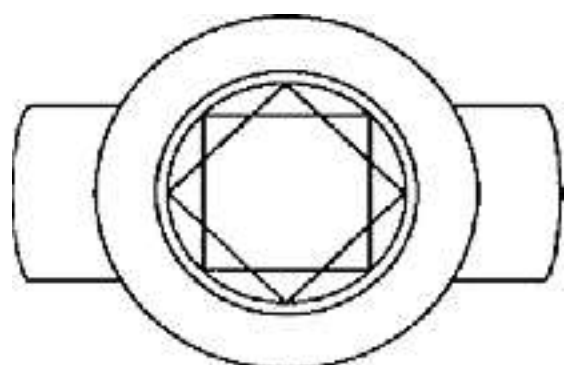

12

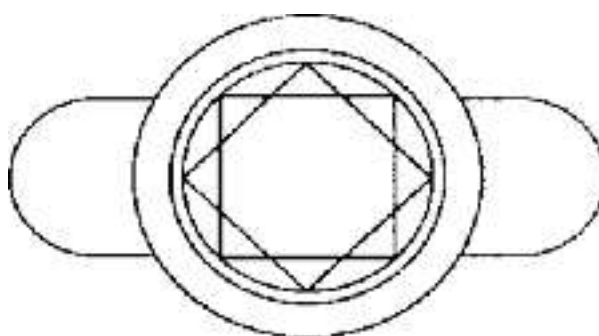

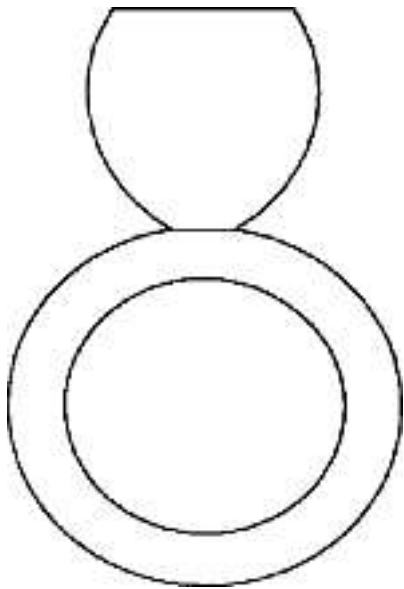

13

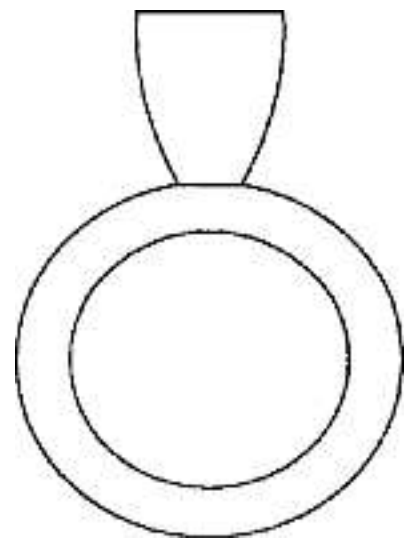

15

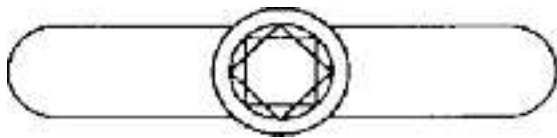

14

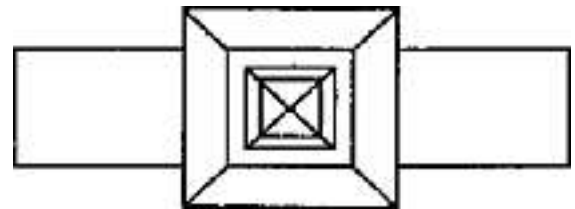

16

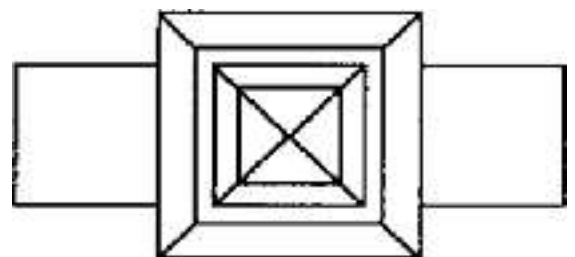
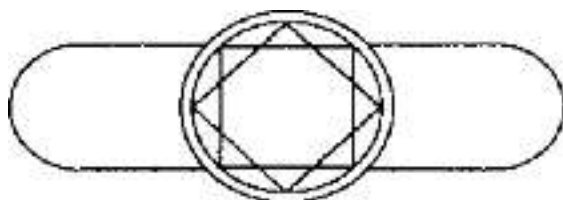
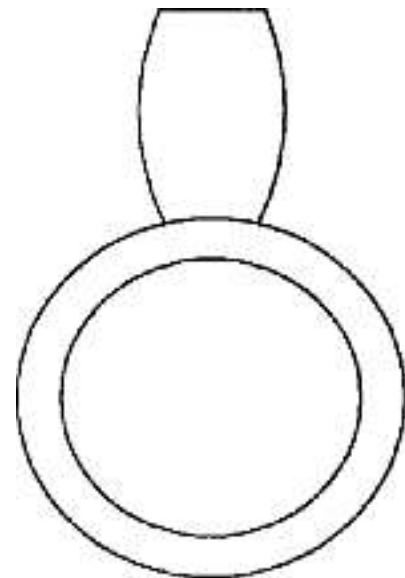
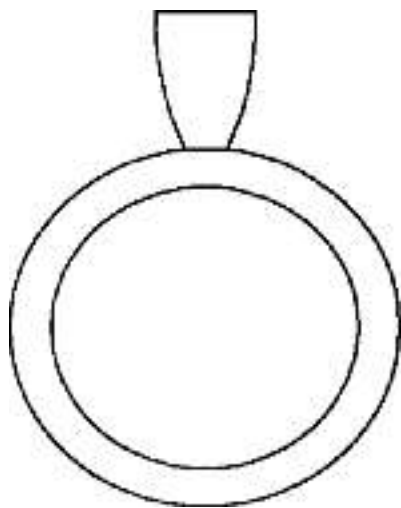

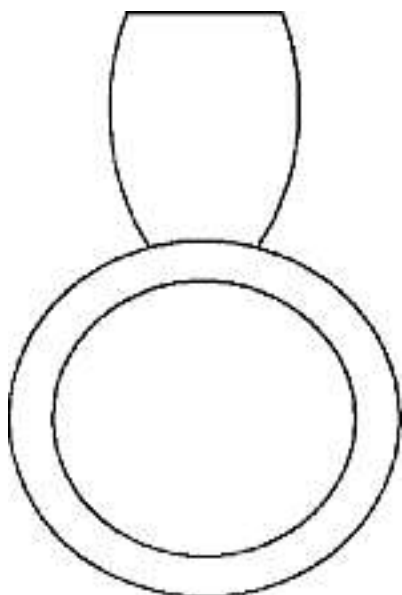

17

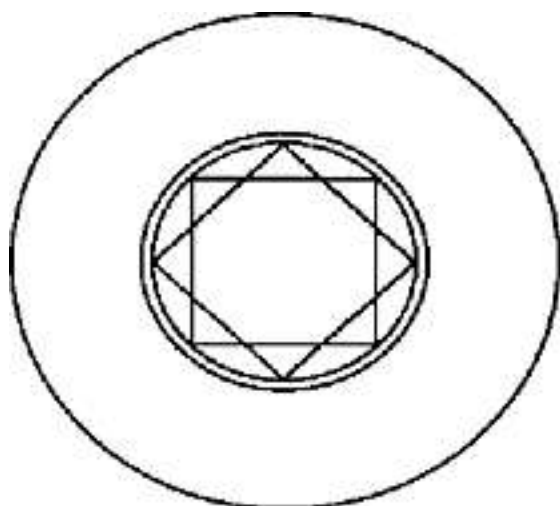

18

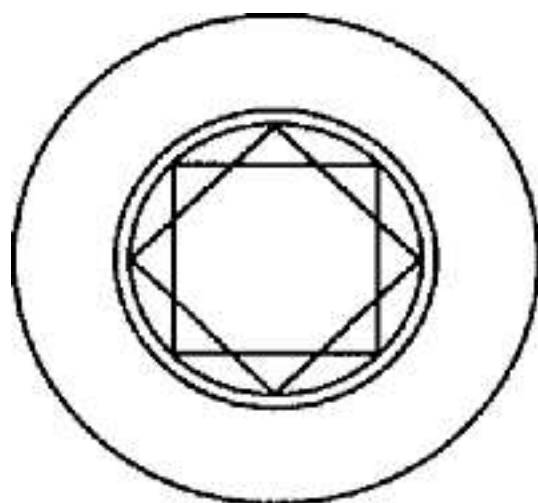

19

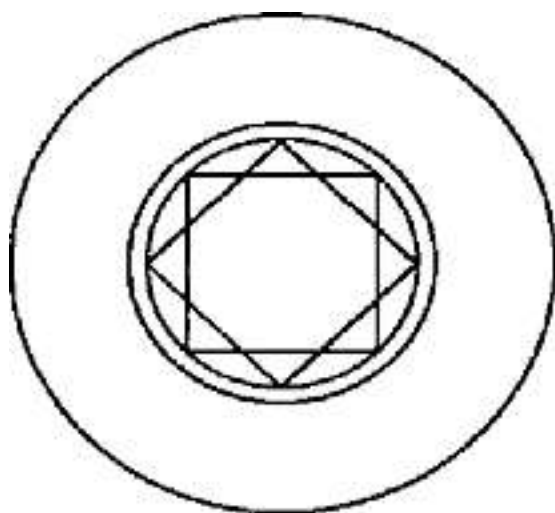

20

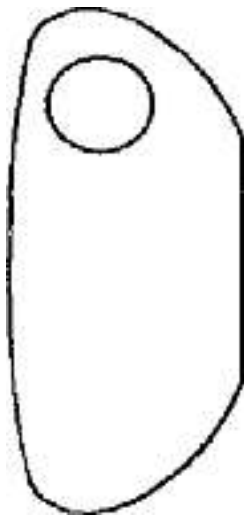

22

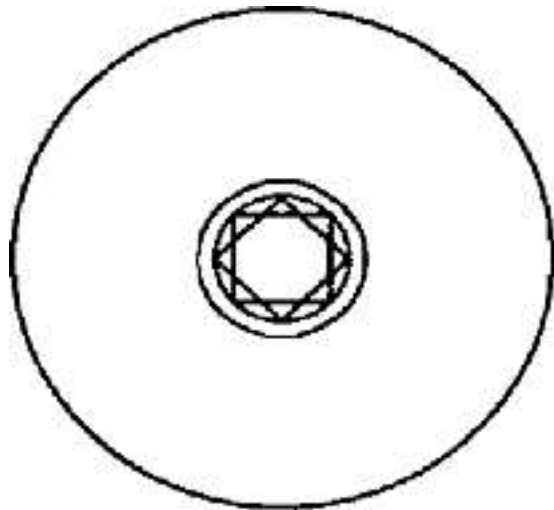
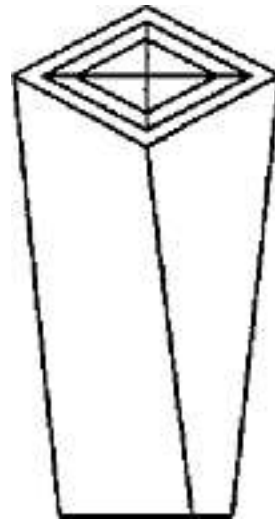

23

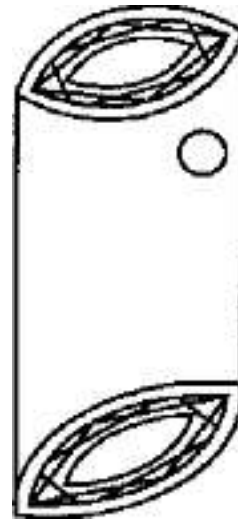

21



24

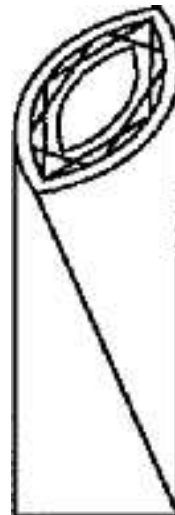

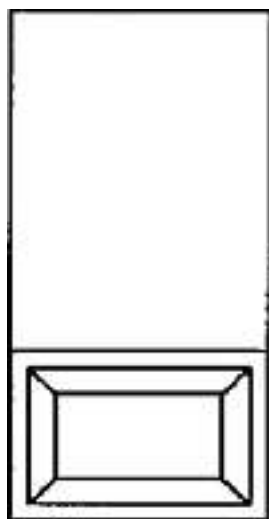

25

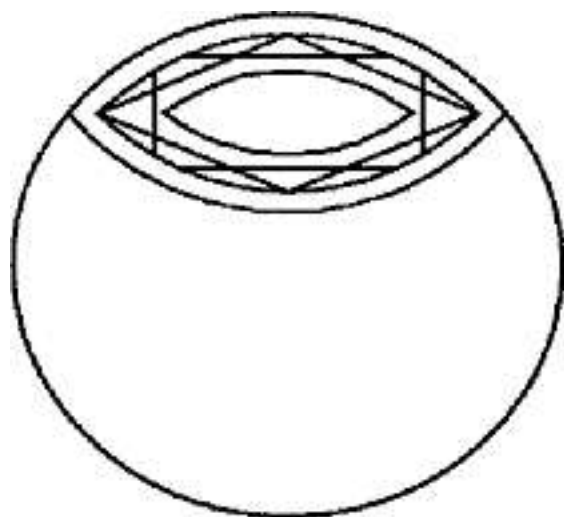
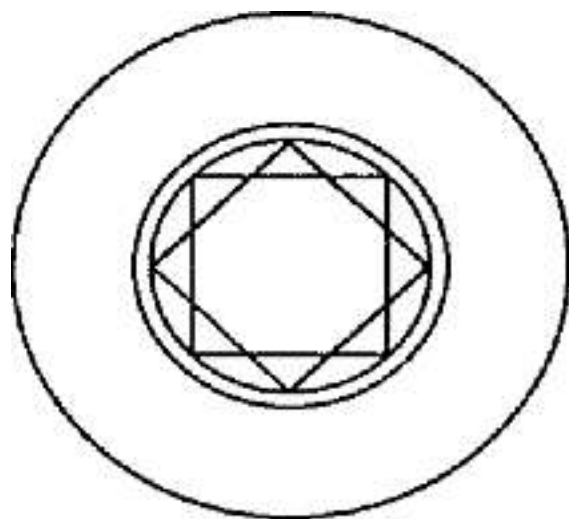

26

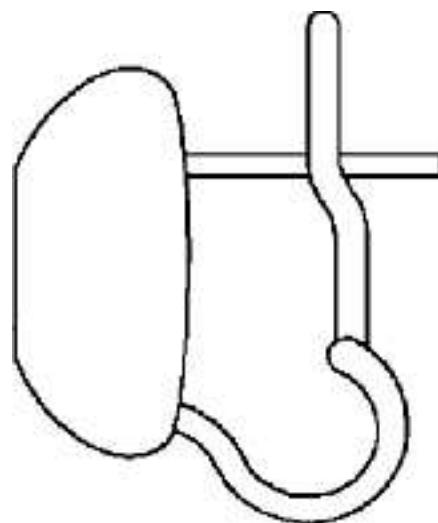

28

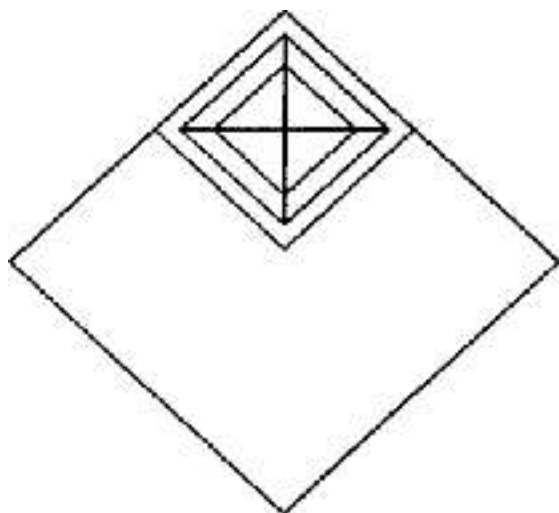

27

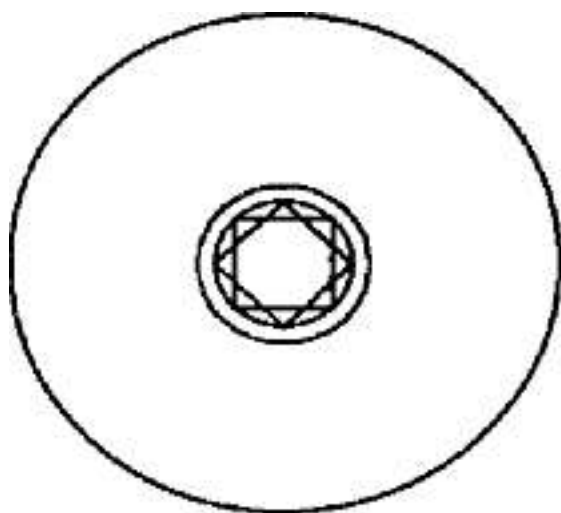

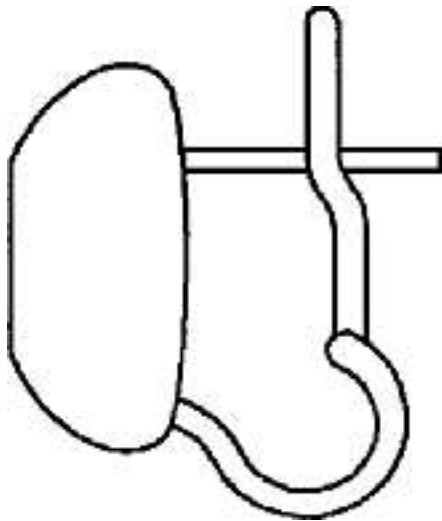

29

Cl. 11-01 130 680 27.05.2004
 2 Design – Schmuck- und Juwelierwaren
 Hinterleger: Xavier de Fraissinette AG, Zugerstrasse 74
 6340 Baar
 Designer: Xavier de Fraissinette, Lyon
 Vertreter: Zimmerli, Wagner & Partner AG, 8001 Zürich

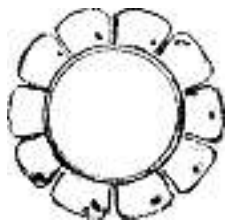

1



2

Cl. 15-05 130 681 22.04.2004
 1 Design – Staubsauger
 Hinterleger: BSH Bosch und Siemens Hausgeräte GmbH,
 Carl-Wery-Strasse 34, München DE
 Designer: Jörg Schröter, Gröbenzell
 Vertreter: Isler & Pedrazzini AG, 8023 Zürich
 Priorität: EM, 27.10.2003





M12895

Cl. 19-02 **130 682** 20.04.2004
 1 Design – Hefter
 Hinterleger: Ideas 4u GmbH, High-Tech-Center, Postfach 220,
 8274 Tägerwilen
 Designer: Walter Wolf Windisch, Tägerwilen
 Vertreter: Patentanwälte Feldmann & Partner AG
 8152 Glattbrugg

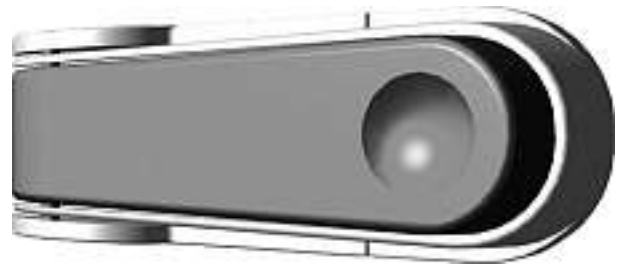
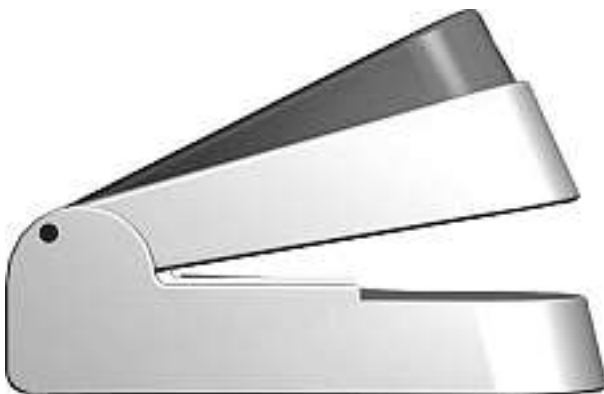

WDH 011/MM/CH

Cl. 20-02 **130 683** 16.04.2004
 2 design – présentoirs
 Déposant: AUDEMARS PIGUET HOLDING S.A., 16, route de
 France, 1348 Le Brassus
 Designer: Wilfred Berney, Le Brassus
 Mandataire: Bugnion S.A., 1211 Genève 12 - Champel





1



2

Cl. 20-02 **130 684** 22.04.2004
1 Design – Displayverkaufsverpackung
Hinterleger: Bourquin SA, Nordringstrasse 23
4702 Oensingen
Designer: Hanspeter Heer, Uettligen



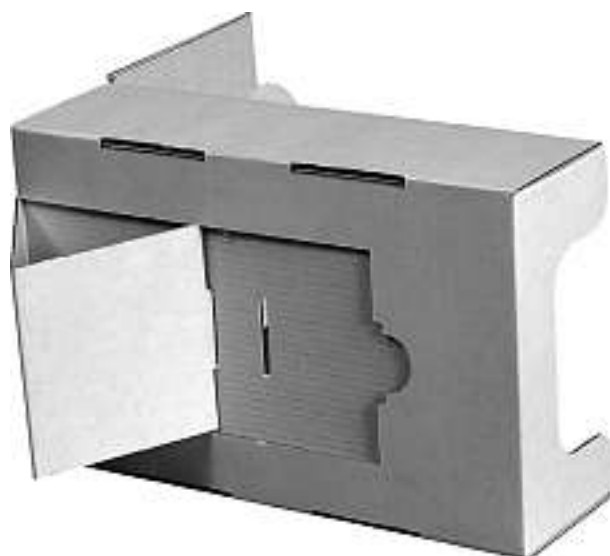
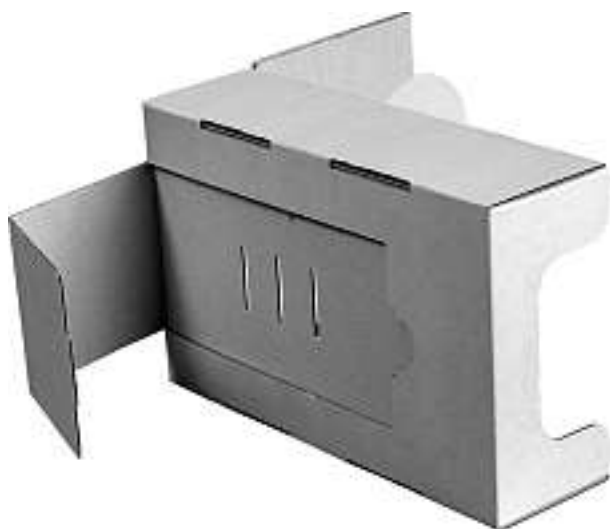

NB 04.100

Cl. 21-01 130 685 22.03.2004
2 design – jeux
Déposant: Laurent Gonnet, En Montandrey
1040 Villars-le-Terroir



Trigon

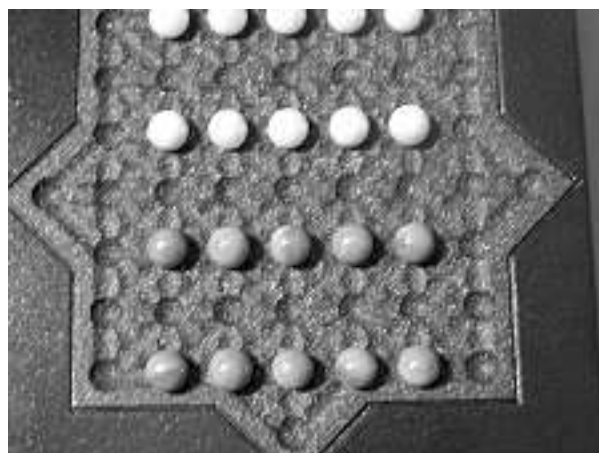
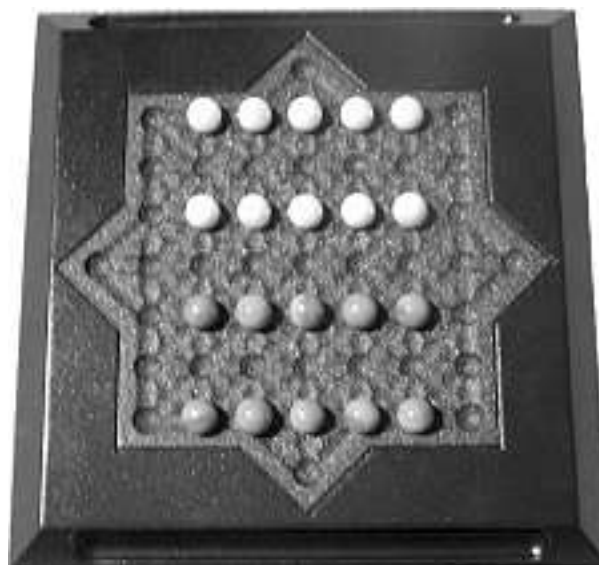

Equivox

Cl. 21-01 130 686 13.04.2004
 1 Design – Frontansicht Spielgerät
 Hinterleger: Karl Fay, Goldbrunnenstrasse 81, 8055 Zürich
 Vertreter: Franz Breitenmoser, 8032 Zürich



Eup-20

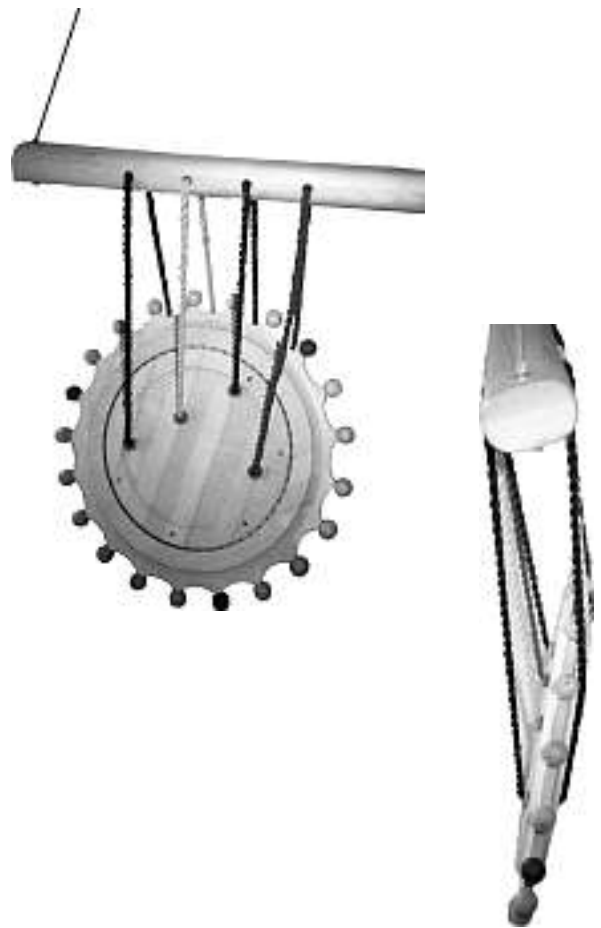

Naguka

Cl. 21-01 130 687 16.04.2004
 1 Design – Spielrad
 Hinterleger: Brigitta Maja Hösli, Hauptstrasse 58
 8274 Tägerwilten

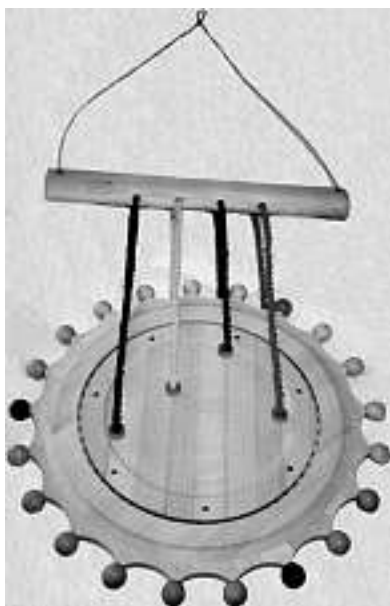

Cl. 23-02 130 688 29.04.2004
 1 design – siège de toilette avec siège pour enfant
 Déposant: Rymax Designs Ltd, 10, Acacia Grove, St Neots /
 Cambs, GB
 Designer: Anthony Michael Courtney, St Neots
 Mandataire: MOINAS & SAVOYE SA, 1201 Genève
 Priorité: GB, 29.10.2003

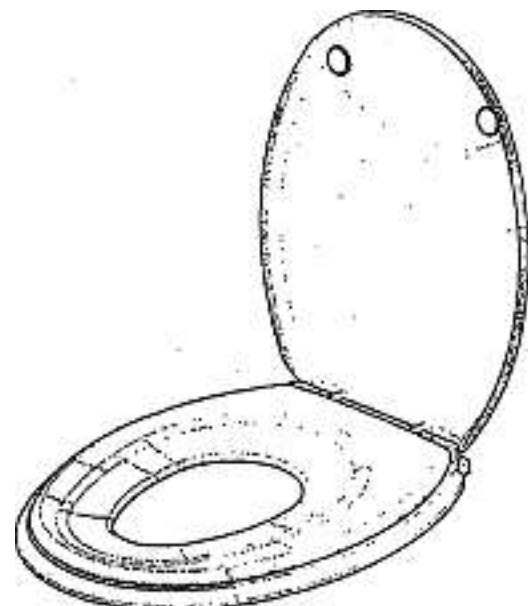

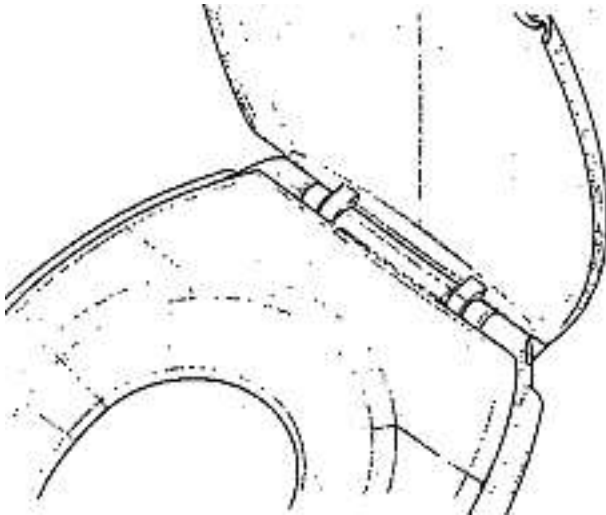
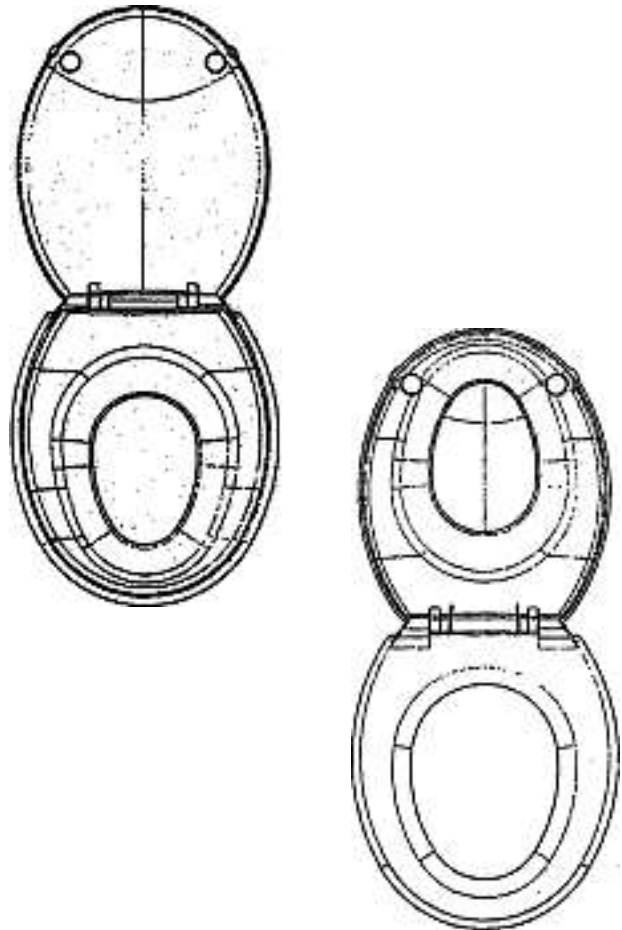
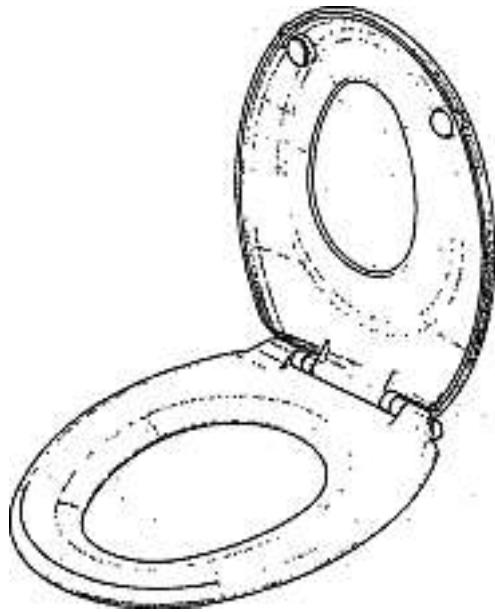

G006.002 CH

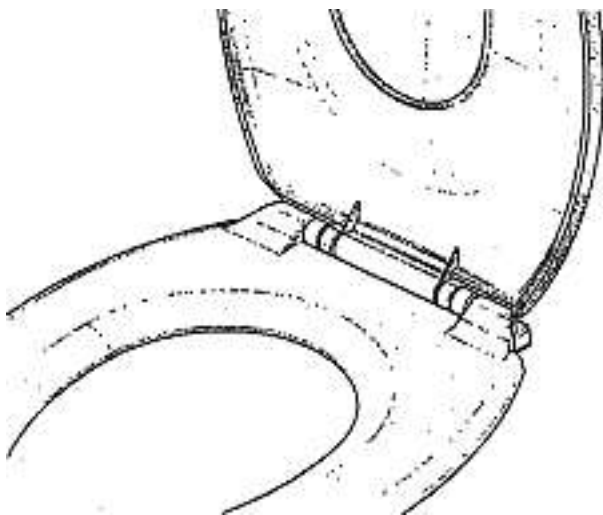

Cl. 23-04 130 689 16.04.2004

2 Design – Ventilator

Hinterleger: MAICO Elektroapparate-Fabrik GmbH,

Steinbeisstrasse 20, 78056 Villingen-Schwenningen DE

Designer: Hans-Udo Liehr, Pforzheim-Eutingen

Vertreter: Troesch Scheidegger Werner AG, 8126 Zumikon

Priorität: DE, 21.11.2003



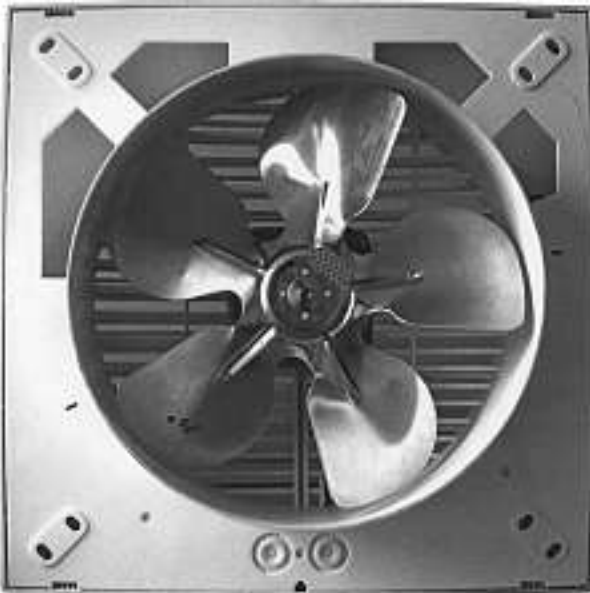
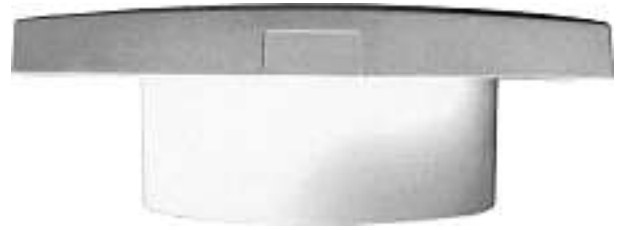
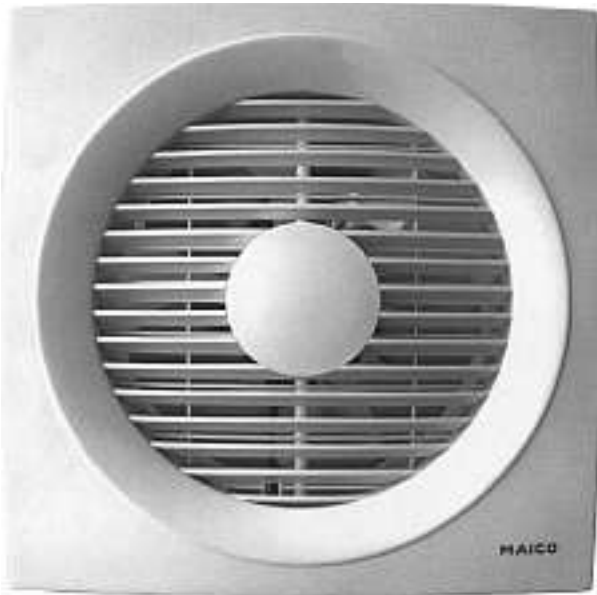

D300035/1

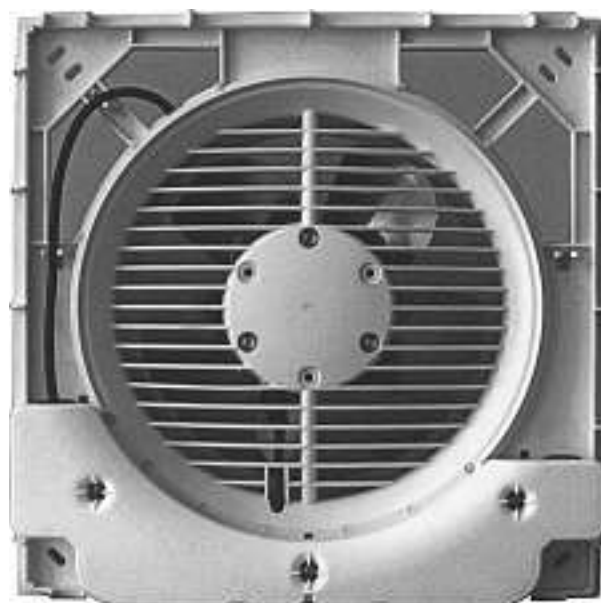
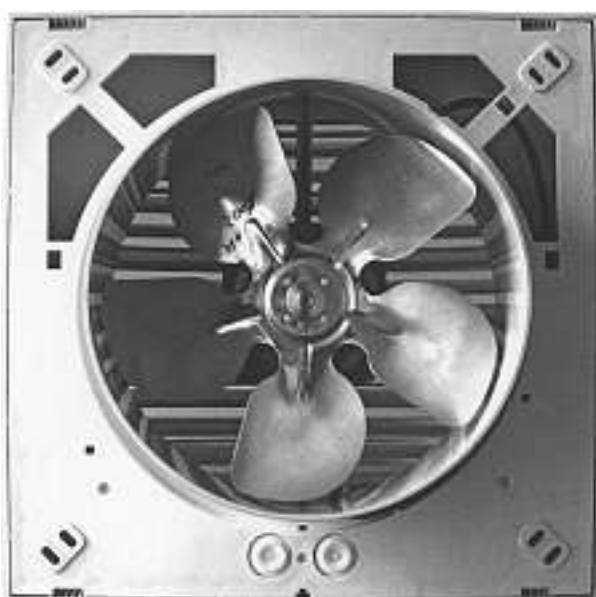

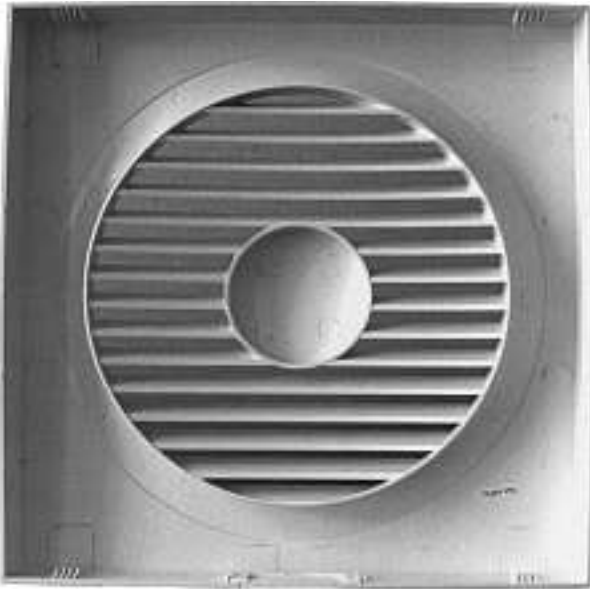

D300035/2

Cl. 23-04 **130 690** 23.04.2004
1 Design – Dunstabzugshaube
Hinterleger: BSH Bosch und Siemens Hausgeräte GmbH,
Carl-Wery-Strasse 34, München DE
Designer: Roland Vetter, Giengen-Sachsenhausen
Vertreter: Isler & Pedrazzini AG, 8023 Zürich
Priorität: EM, 27.10.2003

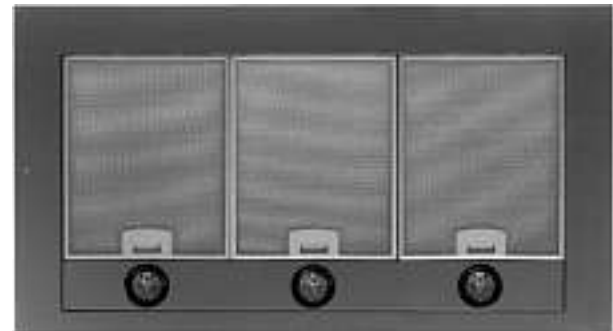
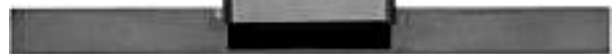



1



Cl. 23-04 **130 691** 23.04.2004
 2 Design – Dunstabzugshauben
 Hinterleger: BSH Bosch und Siemens Hausgeräte GmbH,
 Carl-Wery-Strasse 34, München DE
 Designer: Roland Vetter, Giengen-Sachsenhausen
 Vertreter: Isler & Pedrazzini AG, 8023 Zürich
 Priorität: EM, 27.10.2003

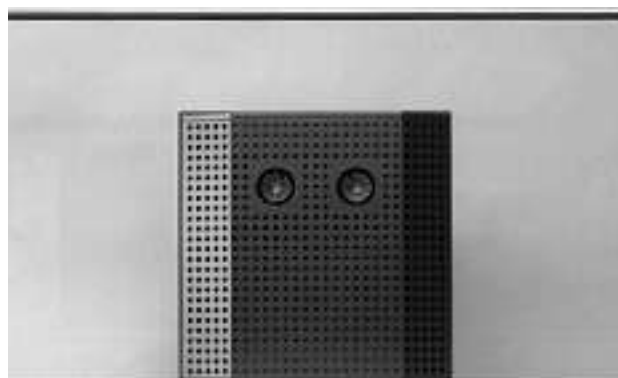



1



2

Cl. 23-04 130 692 23.04.2004

3 Design – Dunstabzugshauben
Hinterleger: BSH Bosch und Siemens Hausgeräte GmbH,
Carl-Wery-Strasse 34, München DE
Designer: Gerd Wilsdorf, Olching
Vertreter: Isler & Pedrazzini AG, 8023 Zürich
Priorität: EM, 27.10.2003

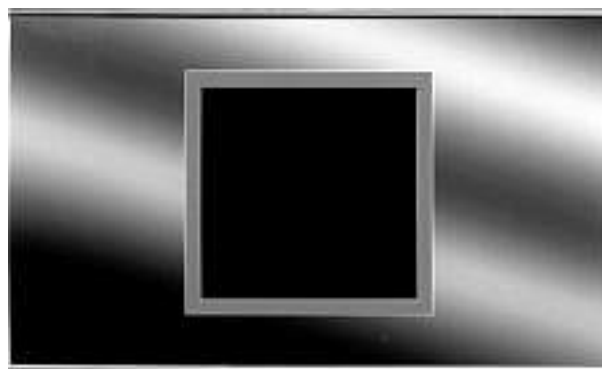

1



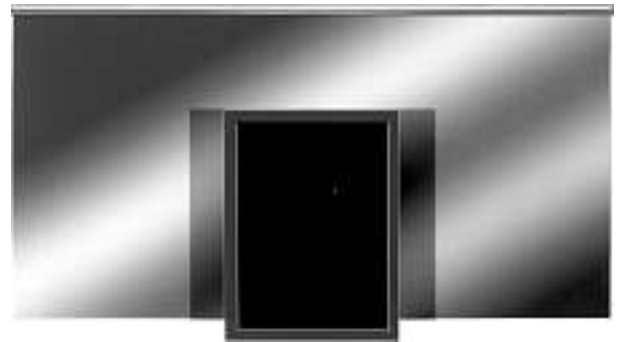

2





3

Cl. 26-05 130 694 15.04.2004
1 Design – Leuchte
Hinterleger: LRG Licht + Raum AG,
Hinterer Schermen 44, 3063 Ittigen
Designer: Beat Kaufmann, Ittigen; David Breil, Bern



DS410

Cl. 26-05 130 695 18.04.2004
6 Design – Lampen
Hinterleger: Belux AG, Bremgarterstrasse 109
5610 Wohlen AG
Designer: Frank O. Gehry, Los Angeles
Vertreter: AXON Patent GmbH, 4147 Aesch



1





2



3



4



5





6



1

Cl. 26-05 130 696 18.04.2004
 2 Design – Lampen
 Hinterleger: Belux AG,
 Bremgarterstrasse 109, 5610 Wohlen AG
 Designer: Erwan Bouroullec, Saint-Denis; Ronan Bouroullec,
 Saint-Denis
 Vertreter: AXON Patent GmbH, 4147 Aesch



2

Cl. 30-02 130 697 15.04.2004
1 Design – Tierbehausung
Hinterleger: Markus Roffler, Lerchenweg 26, 8302 Kloten



310, 315

570

Cl. 99-00 130 698 19.04.2004
3 Design – Urne
Hinterleger: mass-massenware schär & co,
Schwandenholzstrasse 186 A, 8046 Zürich
Designer: Thomas Schär, Zürich



mokkyu



yasura



die urne

**Verlängerungen
Prolongations
Prolongazioni**

117 489 Cl. 23-01 14 Design



D 227 CH - 1



D 227 CH - 2

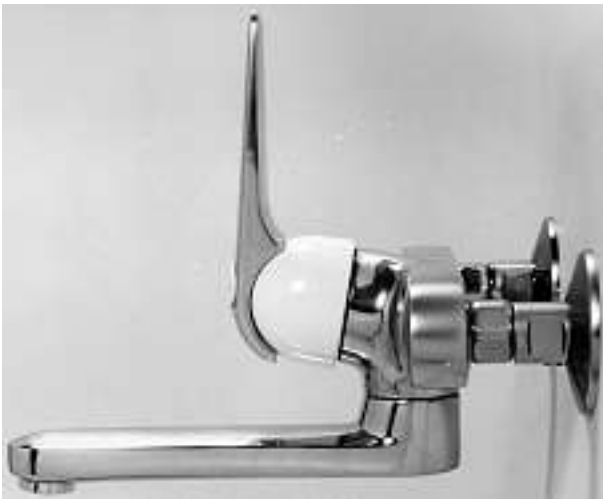

D 227 CH - 3





D 227 CH - 4



D 227 CH - 5

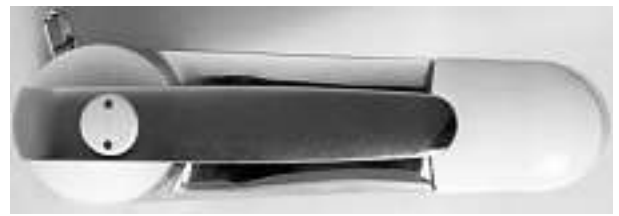

D 227 CH - 6



D 227 CH - 7





D 227 CH - 8



D 227 CH - 9





D 227 CH - 11



D 227 CH - 12



D 227 CH - 10



D 227 CH - 13



D 227 CH - 14

117 496 Cl. 06-04 1 Design

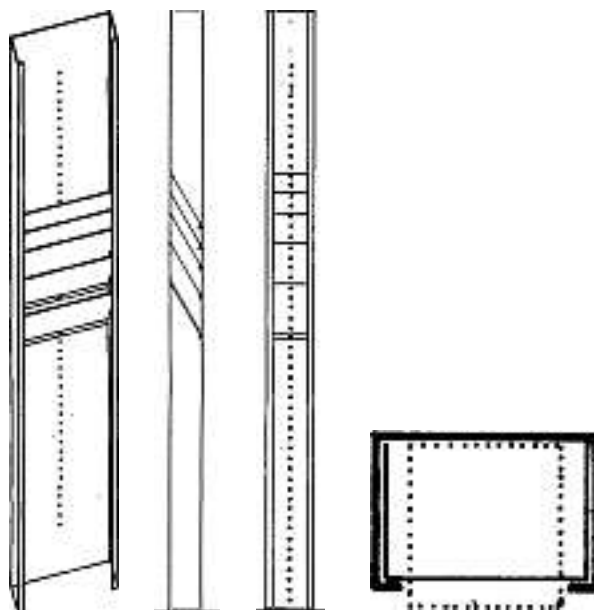

1

117 535 Cl. 09-03 1 Design

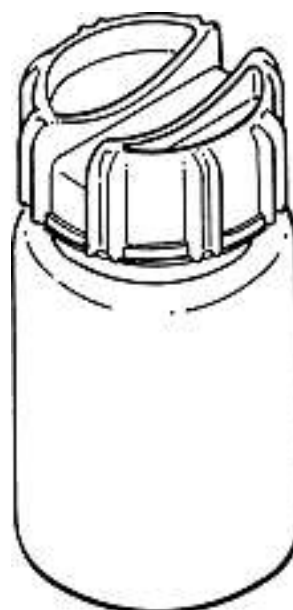

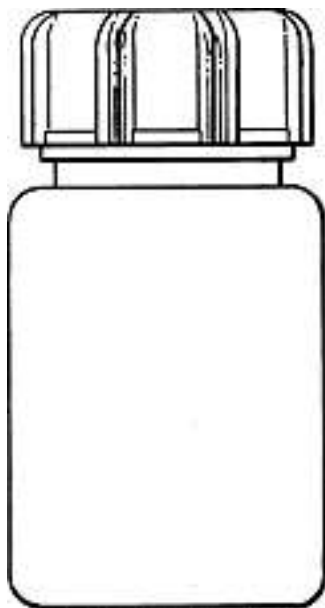
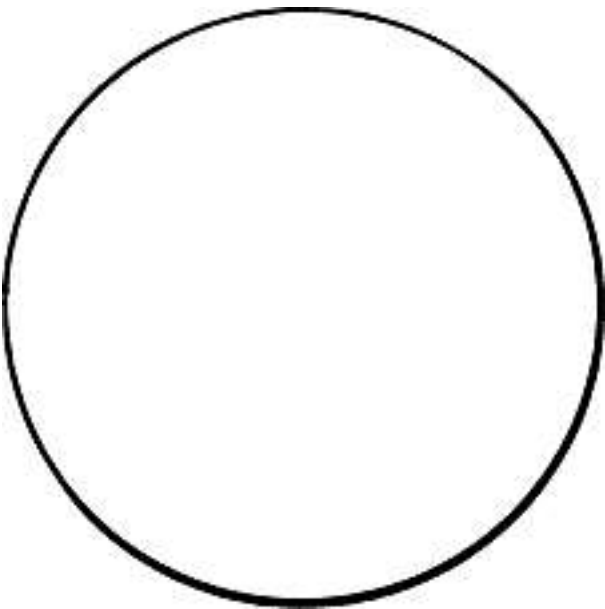

1

117 580 Cl. 09-07 1 Design

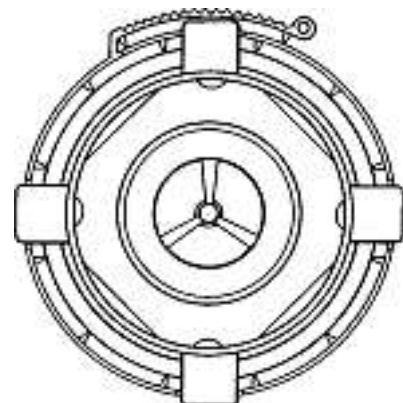
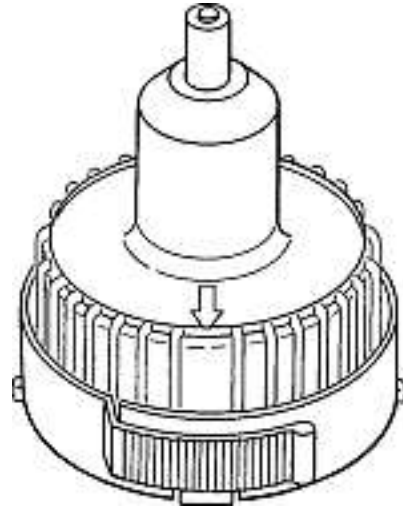

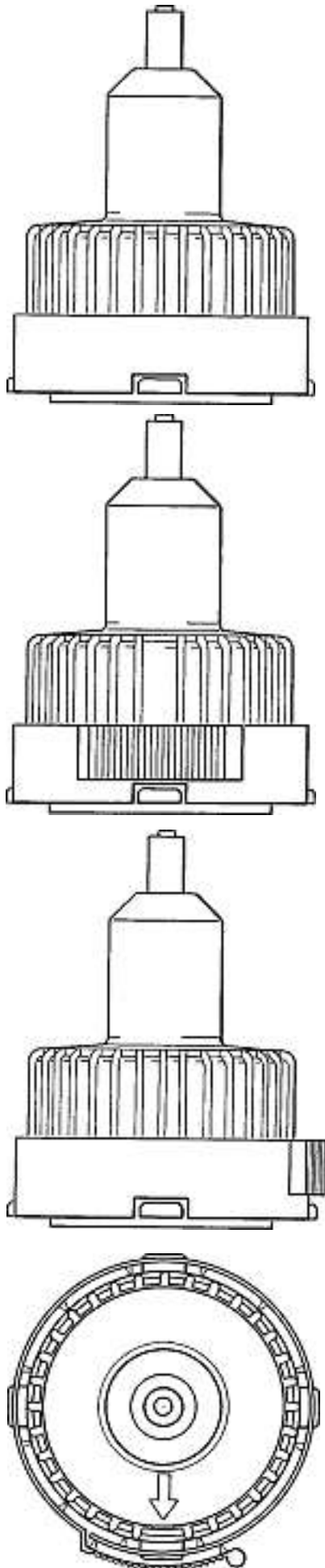

117 585 Cl. 16-03 1 Design

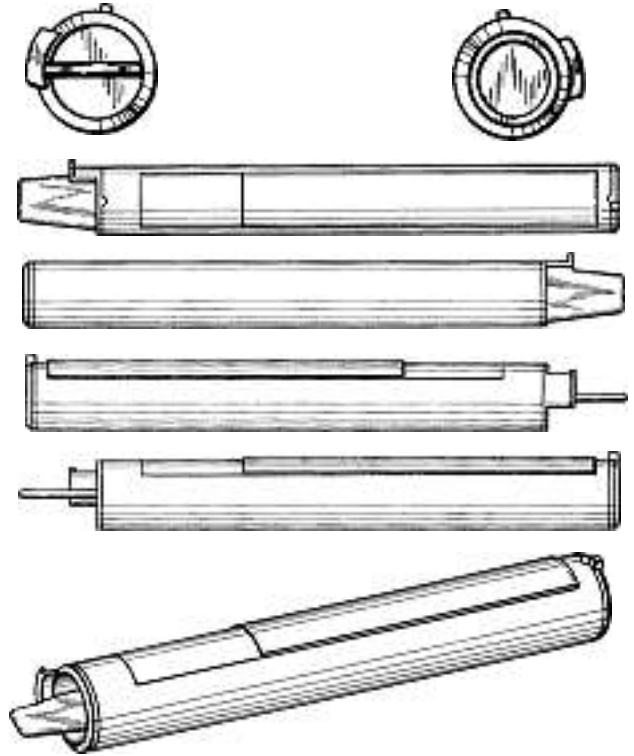

1

120 822	Cl.	06-04	4 Design
121 241	Cl.	06-01	1 Design
121 403	Cl.	06-01	4 Design
121 443	Cl.	06-04	65 Design
121 458	Cl.	07-01	1 Design
121 468	Cl.	08-06	4 Design
121 469	Cl.	09-03	1 Design
121 504	Cl.	09-03	1 Design
121 506	Cl.	09-03	1 Design
121 529	Cl.	26-05	3 Design
121 671	Cl.	02-02	1 design
125 797	Cl.	05-05	1 Design
126 174	Cl.	02-02	1 Design
126 193	Cl.	10-02	1 Design
126 213	Cl.	26-03	1 Design
126 273	Cl.	08-99	3 Design
126 337	Cl.	06-01	1 Design
126 344	Cl.	09-01	1 Design
126 365	Cl.	14-03	1 Design
126 377	Cl.	26-05	2 Design
126 381	Cl.	06-01	7 Design
126 427	Cl.	14-03	1 Design
126 428	Cl.	14-03	1 Design

**Löschungen
Radiations
Radiazioni**

117 036	Cl.	12-99	1 Design
117 066	Cl.	19-04	8 Design
120 917	Cl.	06-04	1 Design
120 967	Cl.	02-01	1 Design
120 974	Cl.	26-01	5 Design
120 977	Cl.	09-03	1 Design
120 989	Cl.	11-01	1 design
120 991	Cl.	12-02	1 Design
120 996	Cl.	25-03	1 design
121 001	Cl.	26-05	32 Design
121 002	Cl.	26-05	1 Design
121 019	Cl.	14-03	1 Design
121 026	Cl.	24-02	1 Design
121 047	Cl.	15-09	1 Design
121 048	Cl.	15-09	1 Design
121 049	Cl.	15-09	1 Design
125 566	Cl.	06-01	3 Design
125 573	Cl.	09-07	1 Design
125 580	Cl.	10-07	1 Design
125 583	Cl.	11-02	1 Design
125 589	Cl.	15-06	1 design
125 591	Cl.	19-03	1 design
125 592	Cl.	19-06	2 design
125 601	Cl.	06-01	33 Design
125 602	Cl.	06-03	2 Design
125 603	Cl.	06-06	3 Design
125 604	Cl.	06-03	2 Design
125 608	Cl.	09-01	1 Design
125 609	Cl.	09-04	1 Design
125 612	Cl.	10-02	1 Design
125 613	Cl.	10-07	15 design
125 615	Cl.	12-14	1 Design
125 616	Cl.	14-02	1 Design
125 618	Cl.	21-01	1 Design
125 619	Cl.	21-02	2 Design
125 621	Cl.	26-05	1 Design
125 624	Cl.	27-06	2 Design
125 625	Cl.	28-03	9 Design
125 632	Cl.	06-04	1 Design
125 671	Cl.	09-03	1 design
125 686	Cl.	21-03	4 Design
125 706	Cl.	07-01	3 Design
125 715	Cl.	09-03	1 Design